



# BATTERY REPLACEMENT DATA BOOK

**2014  
EDITION**

Supersedes 2013 Edition

Use of this data in any format, including electronic format, requires a valid subscription to Source BCI©  
(contact BCI Headquarters at: 330 North Wabash Avenue, Suite 2000, Chicago, IL 60611  
Phone: 312-644-6610) © Copyright 2014 Battery Council International

*Subscribe to the on-line catalog for the latest updates at*

***[www.SourceBCI.com](http://www.SourceBCI.com)***

**Enter the following subscription code  
to access the comprehensive data source**

Please Contact BCI for Your Personal Code

## **SAFETY FIRST!**

**EXPLOSION WARNING:  
BATTERIES CAN EXPLODE!**



### **⚠ DANGER/POISON**

<b>SHIELD EYES.</b> EXPLOSIVE GASES CAN CAUSE BLINDNESS OR INJURY.	<b>NO</b> • SPARKS • FLAMES • SMOKING	<b>SULFURIC ACID</b> CAN CAUSE BLINDNESS OR SEVERE BURNS.	<b>FLUSH EYES IMMEDIATELY WITH WATER. GET MEDICAL HELP FAST.</b>
<b>KEEP OUT OF THE REACH OF CHILDREN</b>	<b>READ INSTRUCTIONS</b>	<b>DO NOT TIP OR OPEN.</b>	

*Vehicle data for 2014-1995:*

**PASSENGER CARS &  
LIGHT TRUCKS**

**TRUCKS**

**FARM EQUIPMENT**

**MOTORCYCLES/SCOOTERS**

**ATVs**

**UTILITY VEHICLES**

**PERSONAL WATERCRAFT**

**SNOWMOBILES**

**LAWN & GARDEN  
EQUIPMENT, TRACTORS/  
SMALL ENGINE**

# 2014 BATTERY REPLACEMENT DATA BOOK

**COLD CRANKING PERFORMANCE @ 0°F** is a rating used to describe battery highrate discharge capability at low temperature. It is the discharge load in amperes that a new, fully charged battery at 0°F (-18°C) can continuously deliver for 30 seconds and maintain a terminal voltage equal to or higher than 1.20 volts per cell. This is the battery rating listed under the heading CCA (0° F) recommended by MOST vehicle manufacturers for use on each vehicle listed in this book. Sometimes a battery may have to provide power for ignition and lighting in the event of failure in the vehicle's electricity generating system. The following definition defines this capability:

**RESERVE CAPACITY** is defined as the number of minutes which a new, fully charged battery at 80°F (27°C) can be continuously discharged at 25 amperes and maintain a terminal voltage equal to or higher than 1.75 volts per cell.

**PERFORMANCE RANGES** listed in the tables of pages 12 through 15 are suggested, based on battery performances normally available. They are provided as a reference only, and are not intended to cover all batteries produced.

## EXPLOSION WARNINGS

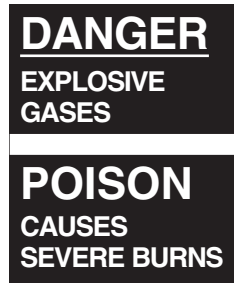
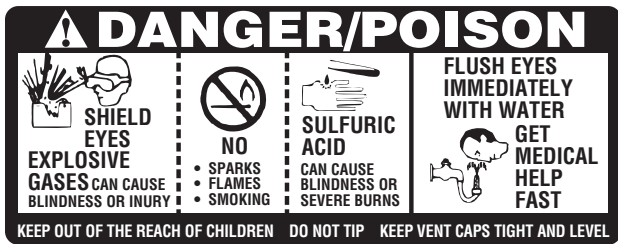

Cigarettes, flames, or sparks could cause battery to explode. Always shield eyes and face from battery. Do not charge or use booster cables or adjust post connections without proper instruction and training.  
**KEEP VENT CAPS TIGHT AND LEVEL**

Contains sulfuric acid. Avoid contact with skin, eyes, or clothing. In event of accident flush with water and call a physician immediately.  
**KEEP OUT OF REACH OF CHILDREN**

Both the graphic and the written messages are in compliance with Rule #16 CFR Part 1500, for use on lead-acid batteries and acid packages under 5 gallons. Either may be used at the discretion of the manufacturer or distributor.

## HEAT SHIELD — CAUTION

Protective heat shields around batteries are being used with increasing frequency to protect the battery from very high under-hood temperatures. Failure to replace the heat shield after installation of a replacement battery may reduce its electrical performance and/or life.

## OLD MODEL VEHICLES — WARNING

Recommendations in this data book assume that modifications affecting battery position have not been made to a vehicle. To avoid possible injury and damage, installers should check that the terminals do not touch compartment walls, holddowns, trays, heat shields, or other metal objects when the hood compartment is closed.

## DISCLAIMER

The replacement battery information in this data book has been obtained from the equipment manufacturers listed, except as otherwise noted. Users are cautioned that the information in this book was the most current information provided to BCI at the time of publication. However, the information is subject to change upon notice from equipment manufacturers or field experience. Therefore, users should use the most current edition of the Battery Replacement Data Book. The Battery Council International and its members, hereafter called BCI, expressly deny any responsibility for the accuracy of the information provided to BCI. While BCI has made every effort to accurately catalog the replacement battery information in this book, BCI disclaims any warranties, expressed or implied, for its accuracy. BCI also denies any liability for damages as a consequence of using the information in this book. Users should also attempt to obtain replacement battery information from the equipment manufacturer's user manual or service department for their specific application.

## BEST-FIT ESTIMATE

Some equipment manufacturers do not provide complete replacement battery information to BCI. BCI estimates a replacement battery size to give some guidance to the Battery Replacement Data Book user. However, the user is cautioned that the size stated is an estimate only, and the user should obtain specific replacement battery size information from the equipment manufacturers.

## COLD CRANKING PERFORMANCE @ 0°F RATINGS IN APPLICATION SECTION

The Cold Cranking Performance ratings listed in the application section of the text, unless otherwise noted, are those of the O.E. or O.E.S. battery(s) provided in each motor vehicle. **THERE IS NO WARRANTY LEVEL OR BATTERY LIFE EXPECTANCY EXPRESSED OR IMPLIED BY THESE VALUES.**

# 2014 BATTERY REPLACEMENT DATA BOOK

CONTENTS	PAGES
Explosion Danger, Installation, Charging, Handling, Booster Cables .....	2-5
Explanation of Data, Abbreviations .....	6
BCI Assembly Numbers, Cell Layouts, Holddowns and Polarity .....	7-11
BCI Group Numbers, Dimensional Specifications and Ratings .....	12-15
BCI/DIN/EN Reference Chart .....	16
BCI/JIS Reference Chart .....	17
Power Sport Battery Type Reference and Terminals Charts.....	18-21

## APPLICATION SECTION

Passenger Cars and Light Trucks .....	22-54
Trucks .....	55-68
Farm Equipment.....	69-76
Lawn & Garden Equipment / Small Engine .....	77-91
POWERSPORT – Motorcycle & Scooter .....	92-101
POWERSPORT – Utility Vehicle .....	101-103
POWERSPORT – ATV .....	103-107
POWERSPORT – Personal Water Craft / Snowmobile / Go-Kart.....	107-112
Part Applications Footnotes.....	Inside Back Cover

**BCI Battery Replacement Data Book – All content is available at  
WWW.SourceBCI.com**

The BCI Data Catalog program conforms to the AAIA - ACES cataloging requirements.

The entire data base is now available at [WWW.SourceBCI.com](http://WWW.SourceBCI.com) in a searchable database. Please go to the website, use the subscription code printed on the front of this Data Book, and register with your name, user name, password and email address.

### WHERE TO FIND WHAT

The following chart provides locations of the various applications provided by BCI's Replacement Data.

<u>Applications</u>	<u>Printed Data Book</u>	<u>WWW.SourceBCI.com</u>
Passenger Cars, Light Trucks, Vans & Mini Vans	1995 - 2014	All Years
Trucks, Buses and Coaches	1995 - 2014	All Years
Farm Equipment	1995 - 2014	All Years
Industrial Off-Road & Miscellaneous Equipment		All Years
Lawn and Garden	1995 - 2014	All Years
Powersport Applications	1995 - 2014	All Years
Power Scrubbers & Aerial Lifts		All Years
Footnotes and Order Forms	1995 - 2014	All Years

**Note:** The Battery Replacement Data Book contains references for 20 years (1995-2014). [WWW.SourceBCI.com](http://WWW.SourceBCI.com) includes all years and additional information on vintage vehicles and other important data. [WWW.SourceBCI.com](http://WWW.SourceBCI.com) is accessible through subscription which is free in 2014. We invite all of our users to contact us at [www.batteryCouncil.org](http://www.batteryCouncil.org) with suggestions for changes and improvements to the Data Book.

The information contained herein is BCI's "best estimate" of the applications for these various products. BCI, its officers, members, directors, agents and staff expressly deny any responsibility for the accuracy of the information provided. For specific questions, please contact your service provider, dealer or manufacturer. BCI disclaims any warranty expressed or implied for its accuracy. BCI further denies any liability for damages as a consequence of using this information. Copyright 2014, Battery Council International, Inc., all rights reserved.

# SAFETY FIRST

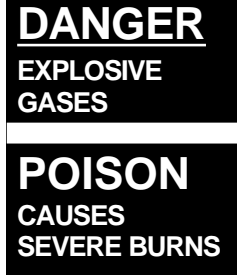

Cigarettes, flames or sparks could cause battery to explode. Always shield eyes and face from battery. Do not charge or use booster cables or adjust post connections without proper instruction and training.  
KEEP VENT CAPS TIGHT AND LEVEL

Contains sulfuric acid. Avoid contact with skin, eyes or clothing. In event of accident flush with water and call a physician immediately.

KEEP OUT OF REACH OF CHILDREN

## DANGER OF EXPLODING BATTERIES

Batteries contain sulfuric acid and produce explosive mixtures of hydrogen and oxygen. Because self-discharge action generates hydrogen gas even when the battery is not in operation, make sure batteries are stored and worked on in a well-ventilated area. ALWAYS wear safety glasses and a face shield when working on or near batteries. When working with batteries:

- \* Always wear proper eye, face, and hand protection.
- \* Keep all sparks, flames, and cigarettes away from the battery.
- \* Do not remove or damage vent caps.
- \* Make sure work area is well ventilated.
- \* Never lean over battery while boosting, testing, or charging.

## SAFE BATTERY INSTALLATION

To assure safe installation and proper operation, follow these installation procedures:

- \* Disconnect ground cable first (this is usually the negative cable; however, older vehicles may have a positive ground).
- \* Remove battery — note position of positive (+) and negative (-) terminals. Mark the cables for correct connection to replacement battery.
- \* Clean terminals and cable connections with a wire brush. Broken connections and frayed or cut cables should be replaced.
- \* Install the replacement battery in the same position as the old one. Secure battery with the holddown assembly.
- \* Make sure the terminals do not touch any metal mounting, engine, or body parts.
- \* Connect cables tightly. Connect ground cable last to avoid sparks.

## SAFE CHARGING

Before beginning the charging operation, read the instructions that come with the charger. Never attempt to charge a battery without first reviewing the instructions for the charger being used. In addition to the charger manufacturer's instructions, these general precautions should be followed:

- \* Always charge batteries in a well-ventilated area and wear proper eye protection.
- \* Turn the charger and timer "OFF" before connecting the leads to the battery to avoid dangerous sparks.
- \* Never try to charge a visibly damaged or frozen battery.
- \* Connect the charger leads to the battery; red positive (+) lead to the positive (+) terminal and black negative (-) lead to the negative (-) terminal. If the battery is still in the vehicle, connect the negative lead to the engine block to serve as a ground. (If the vehicle is positive grounded, connect the positive lead to the engine block.)
- \* Make sure that the leads to the connections are tight.
- \* Set the timer, turn the charger on, and slowly increase the charging rate until the desired ampere value is reached.
- \* If the battery becomes hot or if violent gassing or spewing of electrolyte occurs, reduce the charging rate or temporarily discontinue the charge.
- \* Always turn the charger "OFF" before removing charger leads from the battery to avoid dangerous sparks.

**SAFE HANDLING OF BATTERY ACID**

Battery acid, or electrolyte, is a solution of sulfuric acid and water that can destroy clothing and burn the skin. Use extreme caution when handling electrolyte and keep an acid-neutralizing solution — such as baking soda or household ammonia mixed with water — readily available. When handling battery acid:

- \* **Always wear proper eye, face, and hand protection.**
- \* If the electrolyte is splashed into an eye, immediately force the eye open and flood it with clean, cool water for at least 15 minutes. Get prompt medical attention.
- \* If electrolyte is taken internally, drink large quantities of water or milk. **DO NOT** induce vomiting. Call a physician immediately.
- \* Neutralize any electrolyte that spills on a vehicle or in the work area with baking soda. After neutralizing, rinse the contaminated area clean with water.

To prepare electrolyte of a desired specific gravity, always pour the concentrated acid slowly into the water; **DO NOT pour water into the acid.** Always stir the water while adding small amounts of acid. If noticeable heat develops, allow the solution to cool before continuing to add acid.

**CALIFORNIA PROPOSITION 65 WARNING**

- \* Batteries, battery posts, terminals and related accessories contain lead and lead compounds, chemicals known to the State of California to cause cancer and reproductive harm.
- \* Batteries also contain other chemicals known to the State of California to cause cancer.
- \* **WASH HANDS AFTER HANDLING!**

# EXPLANATION OF DATA

The Data Book is intended to assist the battery aftermarket in the orderly marketing of batteries, for which there is a substantial demand.

Batteries are classified into numbered Group Sizes according to their voltage, maximum overall dimensions, terminal arrangement, and special features that affect battery fit.

## BCI GROUP NUMBERS, DIMENSIONAL SPECIFICATIONS AND RATINGS

Current BCI Group Size Numbers are defined in the tables on pages 12 through 17. The approximate Cold Cranking Performance Range represents the battery performances commonly available in the aftermarket. Each Group Size is listed once and is classified according to the prevailing replacement application for batteries in that Group Size. To determine the correct battery for purchase and installation, refer to the Cold Cranking Performance shown for the specific make, model, or year listed in the application section.

## BCI ASSEMBLY NUMBERS, CELL LAYOUTS, HOLDDOWNS, AND TERMINALS

Numbered sketches (Assembly Figure Numbers) shown under this heading, on pages 7 through 11, illustrate the various terminal arrangements and several typical terminal designs.

## APPLICATION SECTION

This section lists the Group Size and Cold Cranking (CCA) Performance ratings of the Original Equipment battery or batteries provided in each motor vehicle listed. Where Original Equipment (O.E.) CCA is not available, Original Equipment Service (O.E.S.) will be used.

The application information is shown under the following categories:

Passenger Cars and Light Trucks	Lawn & Garden Tractors	POWERSPORT - ATV
Trucks	POWERSPORT - Motorcycle & Scooter	POWERSPORT - Personal Watercraft
Farm Equipment	POWERSPORT - Utility Vehicle	POWERSPORT - Snowmobile

There is 20-year coverage given for all applications listed.

### How to use the Application Section

The manufacturers are arranged alphabetically and an APPLICATION SECTION index is listed on page 3. For Passenger Cars, Light Trucks & Vans, the applications are listed by year and engine size, whereas the remaining vehicles and equipment are listed by model and/or engine numbers. You should determine the following facts in order to assure the proper replacement battery:

- 1 — Locate the desired manufacturer.
- 2 — Determine the year and/or model.
- 3 — Select the correct model or engine.
- 4 — Read across for the BCI Group Number and Original Equipment Cold Cranking Performance.

Whenever a battery Group Number is followed by another Group Number, this indicates a substitute battery, not an exact replacement for the Original Equipment battery. This substitute information is listed only with the approval of the vehicle manufacturer.

Example: 24 or 24F

When more than one battery is required, this is indicated by the number in parentheses following the Group Number.

Example: 31T<sup>(2)</sup>, 31T<sup>(3)</sup>, 31T<sup>(4)</sup>

Regarding the terms "Optional" and "All optional"

Example: 2011 V8 5.0L .....	58	540
Optional .....	65	650
V8 5.8L .....	65	650
All optional .....	65	850

The Group Number 58 with a 540 Cold Cranking Performance is standard equipment on the V8 5.0L. Group 65 with a 650 Cold Cranking Performance is available as an option on the V-8 5.0L and as standard equipment on the V8 5.8L. Group 65 with a 850 Cold Cranking Performance is available as an option on all engines listed under the year 2011.

**Note:** The fact that an optional battery is listed for a particular vehicle does not guarantee that the vehicle will accept the option. For example: The 2011 vehicle listed above could come from the factory with a battery tray large enough only for a Group 58 or it could have a tray which would accept either a Group 58 or a Group 65. **Please observe and carefully note all footnote symbols.**

## ABBREVIATIONS

AC	-Air Conditioning	eng.	-engine	O.E.S.	-Original Equipment Service
A-C	-Allis-Chalmers	ex.	-except	OHC	-Overhead Cam
AGM	-Absorbed Glass Mat	Fed.	-Federal	OHV	-Overhead Valve
Ah	-Amp-hour	Fig.	-Figure	opt.	-optional
Amp	-Ampere	FI	-Fuel Injection	Pkg.	-package
Alt.	-Altitude	Fla.	-Florida	PR Code	-Production Run Code
AT	-Automatic Transmission	FWD	-Front-Wheel Drive	PS	-Power Steering
ATV	-All Terrain Vehicle	gen	-generator	PTO	-Power Take Off
BCI	-Battery Council International	GM	-General Motors	PWC	-Personal WaterCraft
Calif.	-California	GSE	-Gas Starting Engine	RWD	-Rear-Wheel Drive
Can.	-Canada	HBL	-Heated Back Light (rear window defrost)	SC	-Supercharged
carb.	-carburetor	H.D.	-Heavy Duty	SEO	-Special Electrical Option
CAT.	-Caterpillar	H.O.	-High Output	SGB	-Sound Guard Body
cc	-cubic centimeter	HP	-Horsepower	SHO	-Super High Output
CCA	-Cold Cranking Amps (0°F)	HSC	-High Swirl Combustion	SOHC	-Single Overhead Cam
CFI	-Central Fuel Injection	HWS	-Heated Windshield	std.	-standard
comp.	-compression	IHC	-International Harvester Co.	SULEV	-Super Ultra Low Emissions Vehicle
Cont.	-Continental	ind.	-industrial	TBI	-Throttle Body Injection
Conv.	-Convertible	JIS	-Japanese Industrial Standard	TDI	-Turbo Diesel Injection
CVT	-Continuously Variable Transmission	JD	-John Deere	U.S.	-United States
cyl.	-cylinder	L	-Liter	V	-Venturi
DD	-Detroit Diesel	LPG	-Liquified Petroleum Gas	VRLA	- Valve Regulated Lead Acid
DES	-Direct Electric Start	Mex.	-Mexico	2V	-2 Venturi
DIN	-Deutsche Industrie Normen	MFI	-Multi-Port Fuel Injection	w/	-with
DOHC	-Dual Overhead Cam	MT	-Manual Transmission	w/o	-without
EFI	-Electronic Fuel Injection	N/A	-Not Available	Wisc.	-Wisconsin
EN	-European Norm	No.	-Number	WS	-With Sensor
ETR	-Electronic Tuning Radio	O.E.	-Original Equipment	2WD	-2-Wheel Drive
elec.	-electric			4WD	-4-Wheel Drive

# BCI ASSEMBLY NUMBERS, CELL LAYOUTS, HOLDDOWNS AND POLARITY

6-VOLT ASSEMBLIES — TERMINAL POSITIONS & CELL LAYOUTS			
<p>2N</p> <p>FIG. 1</p>	<p>FIG. 2</p>	<p>1 2 3 4 5D 7D 19L</p>	
<p>17HF</p> <p>FIG. 2B</p>	<p>FIG. 5</p>	<p>2E 3EH 4EH</p>	
12-VOLT ASSEMBLIES — TERMINAL POSITIONS & CELL LAYOUTS			
<p>4D 6D 8D</p> <p>FIG. 8</p>	<p>FIG. 9</p>	<p>3EE 3ET</p>	
<p>12T 29H 21 30H 24 34 24H 50 24T 51 25 52 26 86 27 U1® 27H U2®</p> <p>FIG. 10</p>	<p>FIG. 10F</p>	<p>16TF 45 46</p>	
<p>21R 24R 26R 27R 34R 35 51R 85 U1R®</p> <p>FIG. 11</p>	<p>FIG. 11L</p>	<p>17TF</p>	
<p>22F 22HF 22NF 24F 27F 29NF 33</p> <p>FIG. 11F</p>	<p>FIG. 11H</p>	<p>121R 124R</p>	

Ⓐ Holddown Ledge    Ⓑ Bus Terminal (8D only) - Optional    Ⓒ Lifting Ledge    Ⓓ With X Terminal

# BCI ASSEMBLY NUMBERS, CELL LAYOUTS, HOLDDOWNS AND POLARITY

12-VOLT ASSEMBLIES — TERMINAL POSITIONS & CELL LAYOUTS			
60	<p>FIG. 12</p>	<p>FIG. 13</p>	66
53	<p>FIG. 14</p>	<p>FIG. 15</p>	40R 41 42 43 96R 97R 98R
4DLT	<p>FIG. 16L</p>	<p>FIG. 17</p>	70 75 71 76 72 77 73 78 74 101
28 31A 31T	<p>FIG. 18</p>	<p>FIG. 19</p>	36R 54 55 56 58R
61 62 63 64	<p>FIG. 20</p>	<p>FIG. 21</p>	59 65
57	<p>FIG. 22</p>	<p>FIG. 24</p>	47 92 48 93 49 94R 90 95R 91 99R
58	<p>FIG. 26</p>	<p>FIG. 28</p>	151R

Ⓐ Holddown Ledge

# BCI ASSEMBLY NUMBERS, CELL LAYOUTS, HOLDDOWNS AND POLARITY

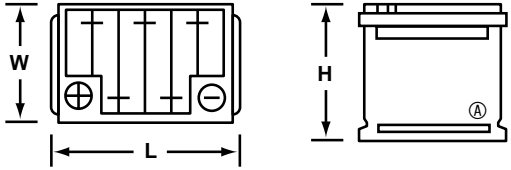
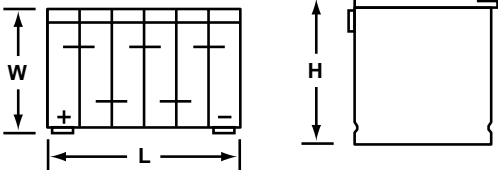
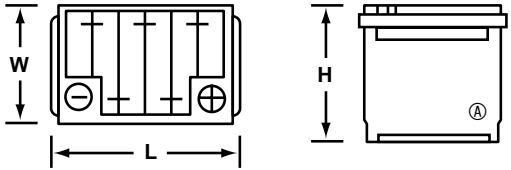
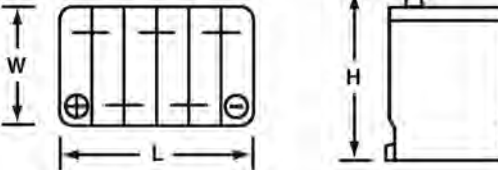
12-VOLT ASSEMBLIES — TERMINAL POSITIONS & CELL LAYOUTS			
<p>99</p>  <p>FIG. 34</p>	 <p>79 100</p> <p>FIG. 35</p>		
<p>67R</p>  <p>FIG. 39</p>	 <p>124</p> <p>FIG. 40</p>		

# BCI ASSEMBLY NUMBERS, CELL LAYOUTS, HOLDDOWNS AND POLARITY

## ORDNANCE BATTERIES 12-VOLT — TERMINAL POSITION & CELL LAYOUTS

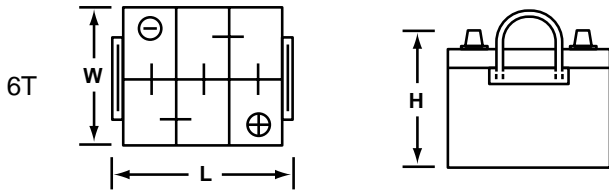

FIG. 27

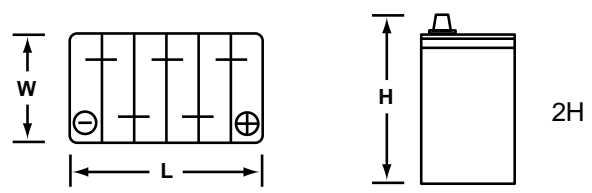

FIG. 28

## ORDNANCE BATTERY 24-VOLT

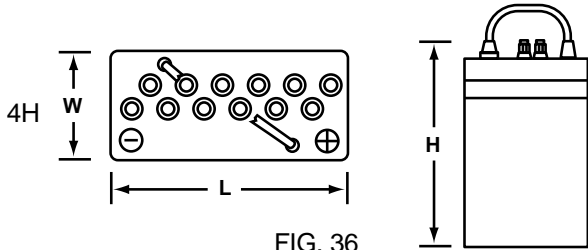

FIG. 36

## ELECTRIC GOLF CAR/UTILITY BATTERIES — TERMINAL POSITION & CELL LAYOUTS

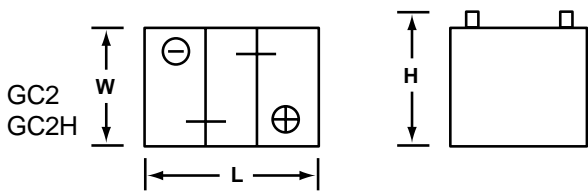

FIG. 2 (6-VOLT 3 CELL)

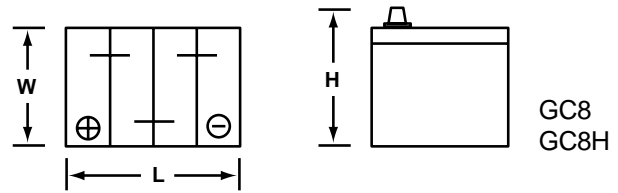

FIG. 31 (8-VOLT 4 CELL)

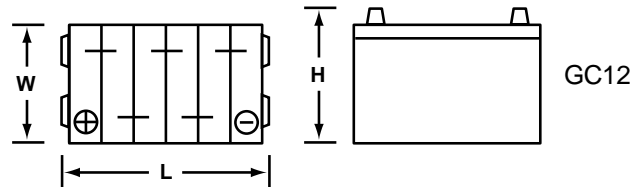
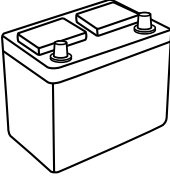
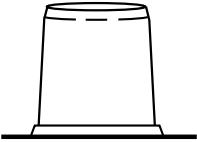
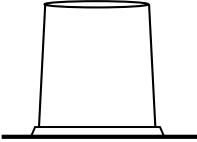
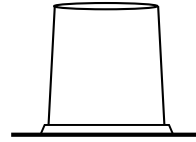
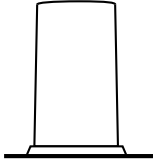
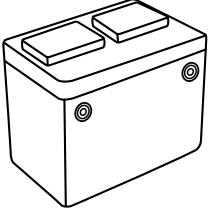
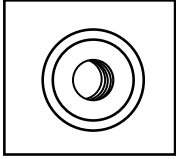
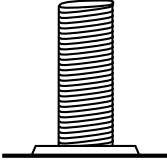
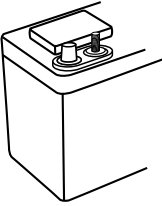
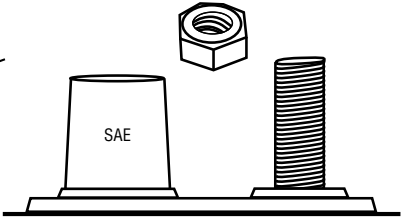
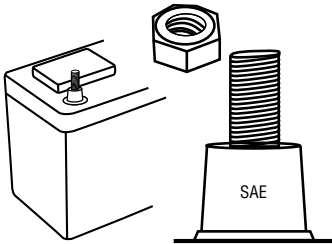
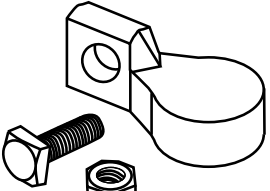
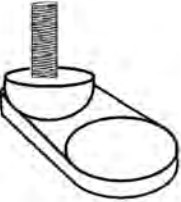
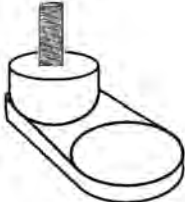
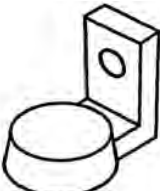

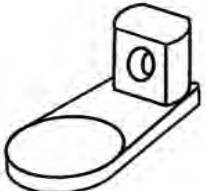
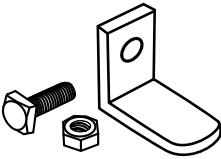
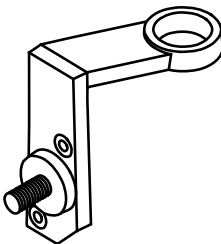
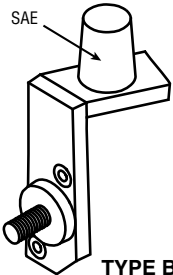
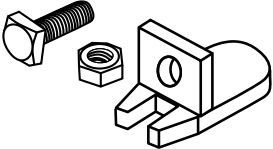
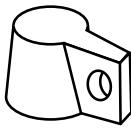
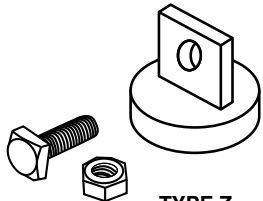
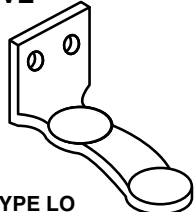

FIG. 32 (12-VOLT 6 CELL)

# BCI POST/TERMINAL CONFIGURATIONS

<p><b>TOP POST</b></p> 	<p><b>SAE</b></p>  <p><b>TYPE A</b></p>	<p><b>DIN</b></p>  <p><b>TYPE A1</b></p>	<p><b>EN/JIS</b></p>  <p><b>TYPE A2</b></p>	<p><b>JIS Pencil Post</b></p>  <p><b>TYPE A3</b></p>
<p><b>SIDE TERMINAL</b></p>   <p><b>TYPE S</b></p>		<p><b>THREADED POST</b></p>  <p><b>TYPE T</b></p>		
<p><b>MARINE</b></p> 	<p><b>WITH HEX</b></p>  <p><b>TYPE M</b></p>		 <p><b>TYPE M1</b></p>	<p><b>FLAG MARINE/SCRUBBER</b></p>  <p><b>TYPE M2</b></p>
<p><b>GOLF CAR AND FLOOR SCRUBBER</b></p>  <p><b>TYPE LPT</b> Low Profile</p>  <p><b>TYPE HPT</b> High Profile</p>  <p><b>TYPE L</b></p>  <p><b>TYPE UT</b></p>  <p><b>TYPE LT</b></p>				
<p><b>GARDEN TRACTOR</b></p>  <p><b>TYPE X</b></p>		<p><b>BUS</b></p>  <p><b>TYPE B</b></p>  <p><b>TYPE B-1</b></p>		
<p><b>SPECIAL APPLICATION</b></p>  <p><b>TYPE F FOX</b></p>		 <p><b>TYPE W</b></p>	 <p><b>TYPE Z</b></p>	<p><b>LOCOMOTIVE</b></p>  <p><b>TYPE LO</b></p>

Designs and designations supplied for reference only. See your battery supplier for dimensional details.

# BCI GROUP NUMBERS, DIMENSIONAL SPECIFICATIONS AND RATINGS

BCI Group Number	Maximum Overall Dimensions						Post/Terminal	Assembly Figure No.	O.E. Performance Ranges	
	Millimeters			Inches					Cold Cranking Performance Amps. @ 0° F (-18° C)	Reserve Capacity Minutes @ 80° F (27° C)
	L	W	H	L	W	H				
<b>PASSENGER CAR AND LIGHT COMMERCIAL BATTERIES 12-VOLT (6 CELLS)</b>										
21	208	173	222	8 3/16	6 13/16	8 3/4	A,A2	10	305-420	50-70
21R	208	173	222	8 3/16	6 13/16	8 3/4	A,A2	11	310-490	50-70
22F	241	175	211	9 1/2	6 15/16	8 5/16	A	11F	230-500	45-90
22HF	241	175	229	9 1/2	6 15/16	9	A	11F	290	69
22NF	240	140	227	9 7/16	5 1/2	8 15/16	A,A2	11F	165-500	50-60
24	260	173	225	10 1/4	6 13/16	8 7/8	A,A2	10	200-900	50-95
24F	273	173	229	10 3/4	6 13/16	9	A,A2	11F	250-710	50-95
24H	260	173	238	10 1/4	6 13/16	9 3/8	A	10	325-410	70-95
24R	260	173	229	10 1/4	6 13/16	9	A,A2	11	550	70-95
24T	260	173	248	10 1/4	6 13/16	9 3/4	A	10	380-500	110
25	230	175	225	9 1/16	6 15/16	8 7/8	A,A2	10	260-550	50-90
26	208	173	197	8 3/16	6 13/16	7 3/4	A,A2	10	245-525	50-80
26R	208	173	197	8 3/16	6 13/16	7 3/4	A	11	235-540	60-80
27	306	173	225	12 1/16	6 13/16	8 7/8	A,A2	10	340-810	102-140
27F	318	173	227	12 1/2	6 13/16	8 15/16	A,A2	11F	315-710	95-140
27H	298	173	235	11 3/4	6 13/16	9 1/4	A	10	420-440	125
27R	306	173	225	12 1/16	6 13/16	8 7/8	A,A2	11	270-700	102-140
29NF	330	140	227	13	5 1/2	8 15/16	A	11F	300-430	95
33	338	173	238	13 5/16	6 13/16	9 3/8	A	11F	1050	165
34	260	173	200	10 1/4	6 13/16	7 7/8	A	10	375-800	100-115
34R	260	173	200	10 1/4	6 13/16	7 7/8	A	11	450-700	110
35	230	175	225	9 1/16	6 15/16	8 7/8	A,A2	11	310-640	80-110
36R	263	183	206	10 3/8	7 3/16	8 1/8	A	19	540-650	130
40R	278	175	175	11	6 15/16	6 15/16	A,A1	15	590-650	110-120
41	293	175	175	11 9/16	6 15/16	6 15/16	A,A1	15	300-720	65-95
42	242	175	175	9 9/16	6 15/16	6 15/16	A,A1	15	210-650	65-95
43	334	175	205	13 1/8	6 15/16	8 1/16	A,A1	15	375-495	115
45	240	140	227	9 7/16	5 1/2	8 15/16	A,A2	10F	400-500	60-80
46	273	173	229	10 3/4	6 13/16	9	A,A1	10F	315-450	75-95
47	242	175	190	9 9/16	6 15/16	7 1/2	A,A1, F	24	290-650	75-85
48	278	175	190	11	6 15/16	7 1/2	A,A1,A2	24	315-770	85-95
49	353	175	190	13 15/16	6 15/16	7 1/2	A,A1,A2	24	470-950	140-150
50	343	127	254	13 1/2	5	10	A	10	500-600	85-100
51	238	129	223	9 3/8	5 1/16	8 3/4	A,A2	10	270-435	70
51R	238	129	223	9 3/8	5 1/16	8 3/4	A,A2	11	310-435	70
52	186	147	210	7 5/16	5 13/16	8 1/4	A	10	405	70
53	330	119	210	13	4 11/16	8 1/4	A	14	210-315	40
54	186	154	212	7 5/16	6 1/16	8 3/8	A	19	305-330	60
55	218	154	212	8 9/16	6 1/16	8 3/8	A	19	370-420	75
56	254	154	212	10	6 1/16	8 3/8	A	19	350-505	90
57	205	183	177	8 1/16	7 3/16	6 15/16	A	22	310	60
58	255	183	177	10 1/16	7 3/16	6 15/16	A	26	245-540	75
58R	255	183	177	10 1/16	7 3/16	6 15/16	A	19	540-580	75

# BCI GROUP NUMBERS, DIMENSIONAL SPECIFICATIONS AND RATINGS

BCI Group Number	Maximum Overall Dimensions						Post/Terminal	Assembly Figure No.	O.E. Performance Ranges	
	Millimeters			Inches					Cold Cranking Performance Amps. @ 0° F (-18° C)	Reserve Capacity Minutes @ 80° F (27° C)
	L	W	H	L	W	H				
<b>PASSENGER CAR AND LIGHT COMMERCIAL BATTERIES 12-VOLT (6 CELLS) Continued</b>										
59	255	193	196	10 1/16	7 11/16	7 3/4	A	21	540-590	100
60	332	160	225	13 1/16	6 5/16	8 7/8	A	12	225-730	65-115
61	192	162	225	7 9/16	6 3/8	8 7/8	A	20	310	60
62	225	162	225	8 7/8	6 3/8	8 7/8	A	20	310-450	75
63	258	162	225	10 3/16	6 3/8	8 7/8	A	20	450	90
64	296	162	225	11 5/8	6 3/8	8 7/8	A	20	475-535	105-120
65	306	192	192	12 1/16	7 9/16	7 9/16	A	21	600-850	130-165
66	306	192	194	12 1/16	7 9/16	7 11/16	A	13	650-750	130-140
67R	231	175	176	9 1/8	6 15/16	6 15/16	A	39	390	65
70	208	180	186	8 3/16	7 1/16	7 5/16	S	17	250-525	60-80
71	208	179	216	8 3/16	7 1/16	8 1/2	S	17	275-450	75-90
72	230	179	210	9 1/16	7 1/16	8 1/4	S	17	275-430	60-90
73	230	179	216	9 1/16	7 1/16	8 1/2	S	17	425-500	80-115
74	260	184	222	10 1/4	7 1/4	8 3/4	S	17	265-550	75-140
75	230	180	186 <sup>Ⓞ</sup>	9 1/16	7 1/16	7 5/16 <sup>Ⓞ</sup>	S	17	245-690	90
76	334	179	216	13 1/8	7 1/16	8 1/2	S	17	750-1075	150-175
77	306	184	222	12 1/16	7 1/4	8 3/4	A	17	350-465	107-110
78	260	180	186	10 1/4	7 1/16	7 5/16	S	17	465-800	105-115
79	307	179	188	12 1/16	7 1/16	7 3/8	S	35	800-840	140
85	230	173	203	9 1/16	6 13/16	8	A	11	430-630	90
86	230	173	203	9 1/16	6 13/16	8	A	10	430-640	90
90	242	175	175	9 9/16	6 15/16	6 15/16	A1,A2	24	450-650	80
91	278	175	175	11	6 15/16	6 15/16	A1,A2	24	520-700	100
92	315	175	175	12 7/16	6 15/16	6 15/16	A1,A2	24	575-720	130
93	353	175	175	13 15/16	6 15/16	6 15/16	A1,A2	24	600-800	150
94R	315	175	190	12 7/16	6 15/16	7 1/2	A1,A2	24	620-790	135
95R	394	175	190	15 9/16	6 15/16	7 1/2	A1,A2	24	760-950	190
96R	242	175	175	9 1/2	6 15/16	6 15/16	A,A1	15	500-590	95
97R	252	175	190	9 15/16	6 15/16	7 1/2	A1,A2	15	575	90
98R	283	175	190	11 1/8	6 15/16	7 1/2	A1,A2	15	620-760	120
99	207	175	175	8 1/8	6 15/16	6 15/16	A1	34	360	50
99R <sup>Ⓞ</sup>	210	175	175	8 5/16	6 15/16	6 15/16	A1	24	470	55-75
100	260	179	188	10 1/4	7 1/16	7 3/8	S	35	770	115
101	260	179	170	10 1/4	7 1/16	6 11/16	S	17	540	115
121R	208	177	215	8 1/4	7	8 1/2	A	11H	500-550	85
124	265	175	214	10 7/16	6 15/16	8 7/16	A	40	700	120
124R	262	177	218	10 3/8	7	8 5/8	A	11H	500-660	110
151R	188	125	225	7 7/16	4 15/16	8 7/8	A	28	270-335	55

**NOTES:**

- Ⓞ Rod End Types — Extend top ledge with holes for holddown bolts.
- Ⓞ Not in application section but still manufactured.
- Ⓞ Maximum height dimension shown includes batteries with raised quarter cover design.  
Flat-top design model height (minus quarter covers) reduced by approximately 3/8 inch (10 mm).

# BCI GROUP NUMBERS, DIMENSIONAL SPECIFICATIONS AND RATINGS

BCI Group Number	Maximum Overall Dimensions						Post/Terminal	Assembly Figure No.	O.E. Performance Ranges	
	Millimeters			Inches					Cold Cranking Performance Amps. @ 0° F (-18° C)	Reserve Capacity Minutes @ 80° F (27° C)
	L	W	H	L	W	H				
<b>PASSENGER CAR AND LIGHT COMMERCIAL BATTERIES 6-VOLT (3 CELLS)</b>										
1	232	181	238	9 1/8	7 1/8	9 3/8	A	2	200-485	105-165
2	264	181	238	10 3/8	7 1/8	9 3/8	A	2	350-650	135-230
2E	492	105	232	19 3/8	4 1/8	9 1/8	A	5	350-475	140
2N	254	141	227	10	5 9/16	8 15/16	A	1	350-450	135
17HF®	187	175	229	7 3/8	6 15/16	9	A	2B	270-400	—
19L	216	178	191	8 1/2	7	7 1/2	A	2	350-400	110
<b>HEAVY-DUTY COMMERCIAL BATTERIES 12-VOLT (6 CELLS)</b>										
4DⓄ	527	222	250	20 3/4	8 3/4	9 13/16	A, B, A2	8	600-1200	225-325
6D	527	254	260	20 3/4	10	10 1/4	A, L	8	750	310
8DⓄ	527	283	250	20 3/4	11 1/8	9 13/16	A, A2, B, B1	8	700-1300	235-465
28	261	173	240	10 1/4	6 13/16	9 7/16	T	18	500	80-135
29H	334	171	232	13 1/8	6 11/16	9 1/8	A	10	350-840	145
30H	343	173	235	13 1/2	6 13/16	9 1/4	A	10	370-1025	120-150
31A	330	173	240	13	6 13/16	9 7/16	A, M, M1	18	660-1000	100-200
31T	330	173	240	13	6 13/16	9 7/16	T, M, M1	18	620-1980	100-200
<b>HEAVY-DUTY COMMERCIAL BATTERIES 6-VOLT (3 CELLS)</b>										
3	298	181	238	11 3/4	7 1/8	9 3/8	A	2	525-660	210-230
4	334	181	238	13 1/8	7 1/8	9 3/8	A	2	440-1000	240-420
5D	349	181	238	13 3/4	7 1/8	9 3/8	A	2	750-1400	310-380
7D	413	181	238	16 1/4	7 1/8	9 3/8	A	2	800-975	370-426
<b>SPECIAL TRACTOR BATTERIES 6-VOLT (3 CELLS)</b>										
3EH	491	111	249	19 5/16	4 3/8	9 13/16	A	5	830-850	220-340
4EH	491	127	249	19 5/16	5	9 13/16	A	5	850-880	340-420
<b>SPECIAL TRACTOR BATTERIES 12-VOLT (6 CELLS)</b>										
3EE	491	111	225	19 5/16	4 3/8	8 7/8	A	9	350	85-105
3ET	491	111	249	19 5/16	4 3/8	9 13/16	A	9	430-620	130-135
4DLT	508	208	202	20	8 3/16	7 15/16	A	16L	630-820	200-290
12T	179	177	202	7 1/16	6 15/16	7 15/16	A, L	10	460	160
<b>GENERAL-UTILITY BATTERIES 12-VOLT (6 CELLS)</b>										
U1	197	132	186	7 3/4	5 3/16	7 5/16	X	10	150-540	23-40
U1R	197	132	186	7 3/4	5 3/16	7 5/16	X	11	165-450	25-37
U2	160	132	181	6 5/16	5 3/16	7 1/8	A3, X	10	235	17
<b>ELECTRIC GOLF CAR/UTILITY BATTERIES 6-VOLT (3 CELLS)</b>										
GC2	264	183	277	10 3/8	7 3/16	10 7/8	LPT, HPT UT, LT	2	Ⓞ	—
GC2H	264	183	295	10 3/8	7 3/16	11 5/8	LPT, HPT UT, LT	2	Ⓞ	—
<b>ELECTRIC GOLF CAR/UTILITY BATTERIES 8-VOLT (4 CELLS)</b>										
GC8	264	183	277	10 3/8	7 3/16	10 7/8	LPT, HPT UT, LT	31	Ⓞ	—
GC8H	264	183	295	10 3/8	7 3/16	11 5/8	LPT, UT LT	31	Ⓞ	—
<b>ELECTRIC GOLF CAR/UTILITY BATTERIES 12-VOLT (6 CELLS)</b>										
GC12	327	183	277	12 7/8	7 3/16	10 7/8	LPT, HPT UT, LT	32	Ⓞ	—

# BCI GROUP NUMBERS, DIMENSIONAL SPECIFICATIONS AND RATINGS

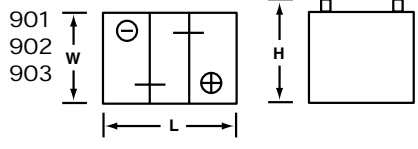
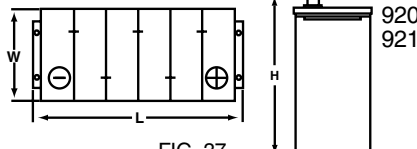
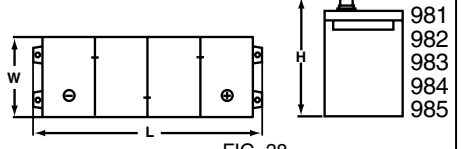
BCI Group Number	Maximum Overall Dimensions						Post/ Terminal	Assembly Figure No.	O.E. Performance Ranges	
	Millimeters			Inches					Cold Cranking Performance Amps. @ 0° F (-18° C)	Reserve Capacity Minutes @ 80° F (27° C)
	L	W	H	L	W	H				
<b>ORDNANCE BATTERIES 12-VOLT (6 CELLS)</b>										
2H ①	260	135	227	10 1/4	5 5/16	8 15/16	A	28	150	75
6T ①	286	267	230	11 1/4	10 1/2	9 1/16	A	27	600-750	180-230
<b>ORDNANCE BATTERIES 24-VOLT (12 CELLS)</b>										
4H ①	273	262	229	10 3/4	10 5/16	9	A	36	125	28
① Submersible										
<b>FLOOR SCRUBBER COMMERCIAL BATTERIES (DEEP CYCLE) 6-VOLT (3 CELLS)</b>										
901	298	181	302	11 3/4	7 1/8	11 7/8	A,L,LPT, HPT,UT,LT	2	—	—
902	302	181	371	12	7 1/8	14 5/8	A,L,LPT, HPT,UT,LT	2	—	—
903	302	181	432	12	7 1/8	17	A,L,LPT, HPT,UT,LT	2	—	—
<b>FLOOR SCRUBBER COMMERCIAL BATTERIES (DEEP CYCLE) 12-VOLT (6 CELLS)</b>										
920	356	171	311	14	6 3/4	12 1/2	A,L,LPT, HPT,UT,LT	37	—	—
921	397	181	378	15 3/4	7 1/8	14 7/8	A,L,LPT, HPT,UT,LT	37	—	—
<b>MARINE/COMMERCIAL BATTERIES 8-VOLT (4 CELLS)</b>										
981	527	191	273	20 3/4	7 1/2	10 3/4	A, L, UT, LT	38	—	—
982	546	191	267	21 1/2	7 1/2	10 1/2	A, L, UT, LT	38	—	—
983	622	191	267	24 1/2	7 1/2	10 1/2	A, L, UT, LT	38	—	—
984	699	191	267	27 1/2	7 1/2	10 1/2	A, L, UT, LT	38	—	—
985	683	216	273	26 7/8	8 1/2	11 3/4	A, L, UT, LT	38	—	—
<b>FLOOR SCRUBBER 6-VOLT</b>			<b>FLOOR SCRUBBER 12-VOLT</b>				<b>MARINE/COMMERCIAL 8-VOLT</b>			
 <p>901 902 903</p> <p style="text-align: center;">FIG. 2</p>			 <p>920 921</p> <p style="text-align: center;">FIG. 37</p>				 <p>981 982 983 984 985</p> <p style="text-align: center;">FIG. 38</p>			

- Ⓜ Rod End Types – Extend top ledge with holes for holddown bolts.
- Ⓝ Not in application section but still manufactured.
- ① Ratings for batteries recommended for Motor Coach and Bus service are for double insulation. When double insulation is used in other types, deduct 15% from the rating values for Cold Cranking Performance.
- Ⓞ Capacity tested in minutes at 75 amperes to 1.75 volts per cell at 80° F (27° C).
- Ⓟ Capacity tested in minutes at 56 amperes to 1.75 volts per cell at 80° F (27° C).

# BCI / DIN / EN REFERENCE CHART

		<b>European Reference Information</b>								
BCI Group Number	BCI Assembly Figure	Maximum Dimensions (mm)			Holddown (see below)	Lifting Ledge	Positive Terminal Location	DIN Code		EN Codes
		Length	Width	Height						
40R	15	278	175	175	B1	No	Right	T6	LB3	66LB
41	15	293	175	175	B4	No	Right	T65	N/A	54LB
42	15	242	175	175	B4	No	Right	T5	LB2	45LB
47	24	242	175	190	B3	Yes	Right	H5	L2	55L2
48	24	278	175	190	B3	Yes	Right	H6	L3	66L3
49	24	354	175	190	B3	Yes	Right	H8	L5	88L5
90	24	242	175	175	B3	Yes	Right	T5	LB2	45LB
91	24	278	175	175	B3	Yes	Right	T6	LB3	66LB
92	24	315	175	175	B3	Yes	Right	T7	LB4	77LB
93	24	354	175	175	B3	Yes	Right	T8	LB5	88LB
94R	24	315	175	190	B3	Yes	Right	H7	L4	77L4
95R	24	394	175	190	B3	Yes	Right	H9	L6	
97R	15	252	175	190	B4	No	Right	H5	L2	55L2
98R	15	283	175	190	B4	No	Right	H6	L3	66L3
99	34	207	175	175	B1	Yes	Left	T4	LB1	36LB
99R	24	210	175	175	B3	Yes	Right	T4	LB1	36LB
N/A	N/A	175	175	190	B3	Yes	Right	H3	L0	32L0
N/A	24	207	175	190	B3	Yes	Right	H4	L1	45L1

### CAUTION

**These are common holddown types but others may be used.**

Holddown descriptions:

B1 = 10.5 mm high with 3 or 5 notches on sides only

B3 = 10.5 mm high on sides with 3 or 5 notches on sides and 3 notches on ends.

B4 = 19.0 mm high on sides only with 3 or 5 notches on sides only

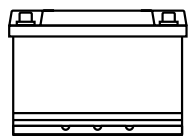

**B1**  
Base holddown 10.5 mm (on long sides)

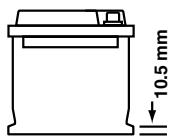

**B3**  
Base holddown 10.5 mm (on long and short sides)

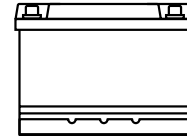
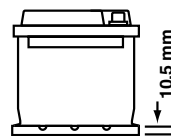
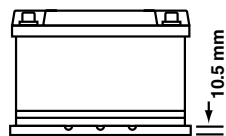

**B4**  
Base holddown 19 mm (on long sides)

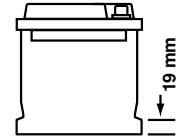

This chart is provided for reference purposes only and is deemed accurate as of the printing of the Data Book. BCI, its members, officers, directors agents and employees expressly deny any responsibility for the accuracy of the information provided. BCI disclaims any warranty, expressed or implied, for its accuracy. BCI also denies any liability for damages as a consequence of using this information.

## BCI / JIS REFERENCE CHART

### Best Fit Estimate - BCI Group Size

BCI Group Number	BCI Assembly Figure	Maximum JIS Dimensions (mm)			JIS Reference Size Number Information	
		Length	Width	Height	JIS Type Designation	Conventional
21	10	202	173	225	50D20R	N50S
21R	11	202	173	225	50D20L	N50SL
24	10	260	173	225	48D26R, 55D26R, 65D26R, 75D26R, 80D26R	N50, N50Z, NS70
24R	11	260	173	225	48D26L, 55D26L, 65D26L, 75D26L, 80D26L	N50L, N50ZL, NS70L
25	10	232	173	225	65D23R, 70D23R, 75D23R	
27	10	306	173	225	65D31R, 75D31R, 95D31R	N70, N70B, NX120
27R	11	306	173	225	65D31L, 75D31L, 95D31L	N70L, N70ZL, NX120-7L
29H <sup>Ⓢ</sup>	10	410	176	234	95E41R, 105E41R, 115E41R, 130E41R 95E41L, 105E41L, 115E41L, 130E41L	N100
35	11	232	173	225	65D23L, 70D23L, 75D23L	
51 <sup>Ⓢ</sup>	10	238	135	227	46B24R, 50B24R, 55B24R, 32C24R	N40, NS60
51R <sup>Ⓢ</sup>	11	238	129	227	32C24L, 46B24L, 50B24L, 55B24L	N40L, NS60L
151R	28	188	125	225	44B19L (S) (SAE TYPE A POST)	
4D	8	505 508	182 222	257 257	115F51 <sup>Ⓢ</sup> , 145F51 <sup>Ⓢ</sup> , 150F51 <sup>Ⓢ</sup> , 170F51 <sup>Ⓢ</sup> 14G51, 165G51, 180G51, 195G51	N120 <sup>Ⓢ</sup> NS150 <sup>Ⓢ</sup>
8D	8	521	278	270	190H52, 245H52	N200
N/A <sup>Ⓢ</sup>	11	194	126	224	S34B20L—Toyota Prius: Remote Venting	
N/A	10	165	124	218	S34B24R—Honda Insight	
N/A	11	248	127	190	46A24L—Mazda Miata: Remote Venting	
N/A	—	167	127	227	26B17L, 26B17R, 28B17L, 34B17L, 28B17R, 34B17R	
N/A	—	187	127	184	26A19L, 26A19R, 28A19R, 32A19R	
N/A	—	187	127	187	26A19L, 28A19R, 32A19R	
N/A	—	187	127	227	28B19L, 28B19R, 34B19L, 34B19R,	
N/A	—	187	127	227	28B19L, 28B19R	
N/A	—	197	129	227	S34B20L, S34B20R, 36B20L, 36B20R, 38B20L, 38B20R	
N/A	—	238	127	227	S46B24L(WS), S46B24R(WS)	
N/A	—	232	173	225	S55D23L, S55D23R, 55D23L, 55D23R	
N/A	—	250	168	227	S65D26L, S65D26R	
N/A	—	305	173	225	S75D31L, S75D31R	N70Z, N70ZL

- Ⓢ OEM post may be small diameter JIS size, connector change may be required.
- Ⓢ BCI designated Group 4D is 38 mm wider than JIS part. 4D will fit most JIS applications.
- Ⓢ BCI Group 29H is 76 mm shorter in length than JIS designated part.
- Ⓢ OE Battery value regulated lead battery.

#### JIS Number Interpretation:

Example - S 65 D 26 R

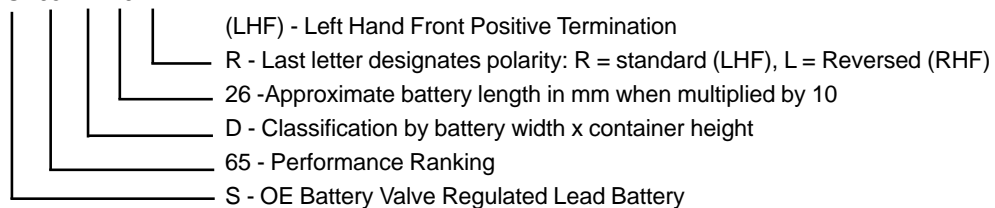

The information contained in this chart is deemed accurate and appropriate at the time of its publication. It represents our "best fit estimate" of the BCI group size to the JIS dimensional reference size. BCI provides this information as a service to the subscribers of the Data Book. While BCI strives for accuracy, it makes no promises or warranties regarding the accuracy or usefulness of this information and expressly disclaims any liability related to the use or reliability of the information contained in this chart. BCI, its officers, directors, employees, agents and its member affiliates cannot be held liable for the accuracy or use of this data.

## POWER SPORT BATTERY TYPE REFERENCE CHART

Battery Type	Volt	Capacity Ah (10 hr)	External Dimensions						Post/ Terminal	Assembly Figure
			Millimeters ( $\pm 2$ )			Inches ( $\pm 1/16$ )				
			L	W	H	L	W	H		
<b>6-VOLT CONVENTIONAL FLOODED LEAD ACID BATTERY</b>										
6N2-2A	6	2	70	46	95	2 3/4	1 13/16	3 3/4	—	
6N2-2A-4	6	2	70	46	95	2 3/4	1 13/16	3 3/4	—	
6N4-2A	6	4	70	70	95	2 3/4	2 3/4	3 3/4	—	
6N4-2A-2	6	4	70	70	95	2 3/4	2 3/4	3 3/4	—	
6N4-2A-4	6	4	70	70	95	2 3/4	2 3/4	3 3/4	—	
6N4-2A-5	6	4	70	70	95	2 3/4	2 3/4	3 3/4	—	
6N4B-2A	6	4	102	48	96	4	1 7/8	3 3/4	—	
6N4B-2A-3	6	4	102	48	96	4	1 7/8	3 3/4	—	
6N6-1D-2	6	6	98	57	108	3 7/8	2 1/4	4 1/4	—	
6N6-3B-1	6	6	99	57	111	3 7/8	2 1/4	4 3/8	6	
6B8L-B	6	8	120	70	95	4 3/4	2 3/4	3 3/4	6	
6N11-2D	6	11	150	69	103	5 7/8	2 11/16	4 1/16	6	
6N11A-1B	6	11	121	60	131	4 3/4	2 3/8	5 3/16	6	
B38-6A	6	13	119	83	161	4 11/16	3 1/4	6 15/16	6	
B39-6	6	7	126	48	126	4 15/16	1 7/8	4 15/16	6	
B49-6	6	10	90	83	161	3 9/16	3 1/4	6 15/16	6	
<b>12-VOLT CONVENTIONAL FLOODED LEAD ACID BATTERY</b>										
12N5-3B	12	5	121	60	130	4 3/4	2 3/8	5 1/8	6	
12N5-4B	12	5	121	60	130	4 3/4	2 3/8	5 1/8	6	
12N5.5-3B	12	5.5	135	60	130	5 5/16	2 3/8	5 1/8	6	
12N5.5-4A	12	5.5	135	60	130	5 5/16	2 3/8	5 1/8	2	
12N7-3B	12	7	135	76	132	5 5/16	3	5 3/16	6	
12N7-4B	12	7	135	76	132	5 5/16	3	5 3/16	6	
12N9-3A	12	9	135	76	139	5 5/16	3	5 1/2	9	
12N9-4B-1	12	9	135	76	139	5 5/16	3	5 1/2	6	
12N24-3	12	24	184	125	175	7 1/4	4 15/16	6 7/8	3	
12N24-3A	12	24	184	125	175	7 1/4	4 15/16	6 7/8	3	
H-12	12	28 (Ah)	200	129	162	7 7/8	5 1/16	6 3/8	9	
<b>12-VOLT HIGH PERFORMANCE FLOODED LEAD ACID BATTERY</b>										
B2.5L-C-1	12	2.5	80	70	105	3 1/8	2 3/4	4 1/8	—	
B3L-A	12	3	100	57	110	3 15/16	2 1/4	4 15/16	6	
B3L-B	12	3	100	57	110	3 15/16	2 1/4	4 15/16	6	
B4L-A	12	4	121	71	92	4 3/4	2 13/16	3 5/8	5	
B4L-B	12	4	121	71	92	4 3/4	2 13/16	3 5/8	5	
B5L-B	12	5	121	60	130	4 3/4	2 3/8	5 1/8	6	
B7-A	12	8	135	76	132	5 5/16	3	5 3/16	6	
B7B-B	12	7	150	60	130	5 7/8	2 3/8	5 1/8	6	
B7C-A	12	8	133	92	116	5 1/4	3 5/8	4 9/16	3	
B7L-B	12	8	135	76	132	5 5/16	3	5 3/16	3	
B9A-A	12	9	135	76	155	5 5/16	3	6 1/8	6	
B9-B	12	9	135	76	138	5 5/16	3	5 7/16	6	
B9L-B	12	9	135	76	138	5 5/16	3	5 7/16	6	

(Ah) @ 20 hr rate

WS = With Sensor

52 = DIN / EN battery part number

## POWER SPORT BATTERY TYPE REFERENCE CHART

Battery Type	Volt	Capacity Ah (10 hr)	External Dimensions						Post/ Terminal	Assembly Figure
			Millimeters (± 2)			Inches (± 1/16)				
			L	W	H	L	W	H		
<b>12-VOLT HIGH PERFORMANCE FLOODED LEAD ACID BATTERY</b>										
B9L-A2	12	9	135	76	138	5 5/16	3	5 7/16	2	
B10A-A2	12	11	135	90	155	5 5/16	3 9/16	6 1/8	8	
B10L-A2	12	11	135	90	145	5 5/16	3 9/16	5 11/16	8	
B10L-B	12	11	135	90	145	5 5/16	3 9/16	5 11/16	6	
B10L-B2	12	11	135	90	145	5 5/16	3 9/16	5 11/16	8	
B12A-A	12	12	134	80	159	5 1/4	3 1/8	6 1/4	6	
SB12A-A <sup>WS</sup>	12	12	134	80	159	5 1/4	3 1/8	6 1/4	6	
B12A-B	12	12	134	80	159	5 1/4	3 1/8	6 1/4	6	
B12AL-A	12	12	134	80	159	5 1/4	3 1/8	6 1/4	6	
B12AL-A2	12	12	134	80	159	5 1/4	3 1/8	6 1/4	8	
B12B-B2	12	12	160	90	131	6 5/16	3 9/16	5 3/16	8	
B12C-A	12	12	134	80	174	5 1/4	3 1/8	6 7/8	4	
B14-A2	12	14	135	90	167	5 5/16	3 9/16	6 9/16	8	
B14-B2	12	14	135	90	167	5 5/16	3 9/16	6 9/16	8	
B14A-A1	12	14	135	90	172	5 5/16	3 9/16	6 3/4	6	
B14A-A2	12	14	135	90	172	5 5/16	3 9/16	6 3/4	5	
B14L-A1	12	14	133	90	167	5 1/4	3 9/16	6 9/16	1	
B14L-A2	12	14	135	90	167	5 5/16	3 9/16	6 9/16	8	
B14L-B2	12	14	135	90	167	5 5/16	3 9/16	6 9/16	8	
SB14L-B2 <sup>WS</sup>	12	14	135	90	167	5 5/16	3 9/16	6 9/16	8	
B16-B	12	19	175	99	156	6 7/8	3 7/8	6 1/8	6	
B16L-B	12	19	175	99	156	6 7/8	3 7/8	6 1/8	6	
B16AL-A2	12	16	205	70	166	8 1/16	2 3/4	6 9/16	2	
B16B-A	12	16	160	89	162	6 5/16	3 1/2	6 3/8	4	
B16B-A1	12	16	160	89	162	6 5/16	3 1/2	6 3/8	7	
B16C-B	12	19	175	99	175	6 7/8	3 7/8	6 7/8	5	
B16CL-B	12	19	175	99	175	6 7/8	3 7/8	6 7/8	5	
B16A-AB	12	16	150	90	181	5 7/8	3 9/16	7 1/16	7	
B16HL-A-LM	12	19	205	90	162	8 1/16	3 9/16	6 3/8	6	
B18-A	12	18	181	90	160	7 1/8	3 9/16	6 5/16	7	
B18L-A	12	18	181	90	160	7 1/8	3 9/16	6 5/16	7	
B50-N18A-A	12	20	205	90	176	8 1/16	3 9/16	6 15/16	7	
B50-N18L-A	12	20	205	90	162	8 1/16	3 9/16	6 3/8	7	
B50-N18L-A3	12	20	205	90	162	8 1/16	3 9/16	6 3/8	4	
B50N-18L-LM	12	20	205	90	162	8 1/16	3 9/16	6 3/8	7	
SB50N-18L-AT <sup>WS</sup>	12	20	205	90	162	8 1/16	3 9/16	6 3/8	7	
B60-N24-A	12	28	184	125	170	7 1/4	4 15/16	6 11/16	3	
B60-N24L-A	12	28	184	125	170	7 1/4	4 15/16	6 11/16	10	
B60-N24AL-B	12	28	184	125	170	7 1/4	4 15/16	6 11/16	3	
B30L-B	12	30	168	132	176	6 5/8	5 3/16	6 15/16	4	
B30CL-B	12	30	168	132	192.2	6 5/8	5 3/16	7 9/16	4	
51814 <sup>52</sup>	12	19 (Ah)	186	82	171	7 7/16	3 1/4	6 3/4	10	
51913 <sup>52</sup>	12	19 (Ah)	186	82	171	7 7/16	3 1/4	6 3/4	10	
53030 <sup>52</sup>	12	30 (Ah)	186	130	171	7 7/16	5 1/8	6 3/4	10	

(Ah) @ 20 hr rate

WS = With Sensor

















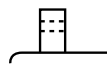
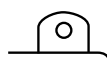

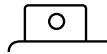

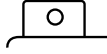



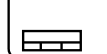

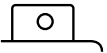

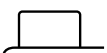
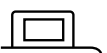

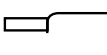
52 = DIN / EN battery part number

## POWER SPORT BATTERY TYPE REFERENCE CHART

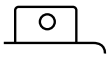
Battery Type	Volt	Capacity Ah (10 hr)	External Dimensions						Post/ Terminal	Assembly Figure
			Millimeters (± 2)			Inches (± 1/16)				
			L	W	H	L	W	H		
<b>12-VOLT AGM LEAD ACID BATTERY</b>										
BTX4L-BS	12	3	113	70	86	4 7/16	2 3/4	3 3/8	5	
BTX5L-BS	12	4	113	70	105	4 7/16	2 3/4	4 1/8	5	
BT7B-BS	12	6	150	65	93	5 7/8	2 9/16	3 11/16	11	
BTX7L-BS	12	6	113	70	129	4 7/16	2 3/4	5 1/16	4	
BTX7A-BS	12	6	150	87	90	5 7/8	3 7/16	3 9/16	4	
BTX9-BS	12	8	150	87	105	5 7/8	3 7/16	4 1/8	5	
BTR9-BS	12	8	150	87	105	5 7/8	3 7/16	4 1/8	11	
BTX12-BS	12	10	150	88	130	5 7/8	3 1/2	5 1/8	5	
BT12A-BS	12	10	150	87	105	5 7/8	3 7/16	4 1/8	11	
BTX14-BS	12	12	150	87	146	5 7/8	3 7/16	5 3/4	5	
BTX14AH-BS	12	12	134	89	166	5 1/4	3 1/2	6 9/16	4	
BTX14AHL-BS	12	12	134	89	166	5 1/4	3 1/2	6 9/16	4	
BTX14L-BS	12	12	150	87	145	6	3 7/16	5 3/4	5	
BTX15L-BS	12	13	175	87	130	6 7/8	3 7/16	5 1/8	4	
BTX16-BS	12	14	150	88	161	5 7/8	3 7/16	6 15/16	4	
BTX16-BS-1	12	14	150	88	161	5 7/8	3 7/16	6 15/16	1	
BT19BL-BS	12	17.7	185	81	170	7 5/16	3 3/16	6 11/16	10	
BTX20-BS	12	18	175	87	155	6 7/8	3 7/16	6 1/8	4	
BTX20CH-BS	12	18	150	87	161	6	3 7/16	6 3/8	4	
BTX20L-BS	12	18	175	87	155	6 7/8	3 7/16	6 1/8	4	
BTX20H-BS	12	18	175	87	155	6 7/8	3 7/16	6 1/8	4	
BTX20HL-BS	12	18	175	87	155	6 7/8	3 7/16	6 1/8	4	
BTX24HL-BS	12	21	205	87	162	8 1/16	3 7/16	6 3/8	4	
<b>12-VOLT FACTORY ACTIVATED ABSORBED GLASS MAT (AGM) BATTERY</b>										
BT4B-5	12	2.5	113	38	86	4 7/16	1 1/2	3 3/8	12	
BT7B-4	12	6	150	65	93	6	2 9/16	3 11/16	11	
BT9B-4	12	8	150	69	105	5 7/8	2 11/16	4 1/8	11	
BT12B-4	12	10.5	150	69	130	6	2 3/4	5 1/8	11	
BT14B-4	12	12	150	87	146	5 7/8	3 7/16	5 3/4	11	
BTZ5S	12	4	113	70	85	4 7/16	2 3/4	3 3/8	5	
BTZ7S	12	6	113	70	105	4 7/16	2 3/4	4 1/8	5	
BTZ10S	12	8	150	87	93	5 7/8	3 7/16	3 11/16	11	
BTZ12S	12	11	150	87	110	5 7/8	3 7/16	4 5/16	11	
BTZ14S	12	11.2	150	87	110	5 7/8	3 7/16	4 5/16	11	
BTX14	12	12	150	87	146	5 7/8	3 7/16	5 3/4	5	
BTX15L	12	13	175	87	130	6 7/8	3 7/16	5 1/8	4	
BTZ16H	12	16	150	87	145	6	3 7/16	5 3/4	5	
BTX20L	12	18	175	87	155	6 7/8	3 7/16	6 1/8	4	
BTX24HL	12	21	205	87	162	8 1/16	3 7/16	6 3/8	4	
BTX30L	12	30	166	126	175	6 9/16	4 15/16	6 7/8	4	
BTZ20L	12	20	175	87	155	6 7/8	3 7/16	6 1/8	4	

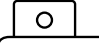
(Ah) @ 20 hr rate  
 WS = With Sensor  
 52 = DIN / EN battery part number

## TERMINALS

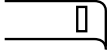
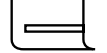
Type	Terminal Shape			Battery Type				
	Front	Side	Top					
<b>1</b>				BTX16-BS-1	B14L-A1			
<b>2</b>				B9L-A2	B16AL-A2	12N5.5-4A		
<b>3</b>				12N24-3 B60-N24AL-B	12N24-3A	B7C-A	B7L-B	B60-N24-A
<b>4</b>				BTX14AH-BS BTX20L-BS B12C-A BTX15L	BTX14AHL-BS BTX20H-BS B16B-A BTX20L	BTX15L-BS BTX20HL-BS B50-N18L-A3 BTX24HL	BTX16-BS BTX24HL-BS B30L-B BTZ20L	BTX20-BS BTX20CH-BS B30CL-B
<b>5</b>				BTX4L-BS BTX12-BS BTX30L B16CL-B	BTX5L-BS BTX14-BS B4L-A BTZ5S	BTX7A-BS BTX14L-BS B4L-B BTZ16H	BTX7L-BS BTZ7S B14A-A2	BTX9-BS BTX14 B16C-B
<b>6</b>				B3L-A B9-B B12A-B B16HL-A-LM 12N7-3B 6N6-3B-1	B3L-B B9L-B B12AL-A SB12A-A 12N7-4B 6B8L-B	B5L-B B9A-A B14A-A1 12N5-3B 12N9-4B-1 B38-6A	B7-A B10L-B B16-B 12N5-4B 6N11-2D B39-6	B7B-B B12A-A B16L-B 12N5.5-3B 6N11A-1B B49-6
<b>7</b>				B16A-AB B50-N18L-A	B16B-A1 B50-N18L-LM	B18-A SB50N-18L-AT	B18L-A	B50-N18A-A
<b>8</b>				B10A-A2 B14-A2	B10L-A2 B14-B2	B10L-B2 B14L-A2	B12AL-A2 B14L-B2	B12B-B2 SB14L-B2
<b>9</b>				H-12	12N9-3A			
<b>10</b>				51814 <sup>52</sup>	51913 <sup>52</sup>	53030 <sup>52</sup>	B60-N24L-A	BT19BL-BS
<b>11</b>				BT7B-4 BT14B-4	BT9B-4 BT7B-BS	BTZ10S BTR9-BS	BT12B-4 BTZ12S	BT12A-BS BTZ14S
<b>12</b>				BT4B-5				

52 = DIN / EN battery part number

# Passenger Car & Light Truck

YEAR	ENGINE/ OPTIONS	FOOT NOTE	GROUP/ TYPE NO.	O.E. CCA (@0°F)	YEAR	ENGINE/ OPTIONS	FOOT NOTE	GROUP/ TYPE NO.	O.E. CCA (@0°F)	YEAR	ENGINE/ OPTIONS	FOOT NOTE	GROUP/ TYPE NO.	O.E. CCA (@0°F)
<b>ACURA</b>					<b>ASTON MARTIN (Cont.)</b>					<b>AUDI (Cont.)</b>				
<b>CL</b>					<b>DB9</b>					<b>A4</b>				
2003-01	V6 3.2L	11	24	550	2014-05	V12 6.0L	54,66	49	830	2014-13	L4 2.0L PR-J0L	54,57,66,67,70	48	570
1999-98	L4 2.3L	11	24F	550	<b>DBS</b>					2014-13	L4 2.0L PR-J1L	54,57,66,67,70	47	540
1999-97	V6 3.0L	11	24	550	2012-08	V12 6.0L	54,66	49	830	<b>Rapide</b>				
1997	L4 2.2L		24F	550	<b>V12 Vantage</b>					2014-13	L4 2.0L PR-J2D	54,57,66,67,69,70	48	680
<b>CSX</b>					2014-11	V12 6.0L	54,66	49	830	2014-09	L4 2.0L PR-J0B	54,57,66,67,69,70	49	850
2011-08	L4 2.0L		51R	410	<b>V8 Vantage</b>					2014-09	L4 2.0L PR-J0P	54,57,66,67,69,70	95R	950
2007	L4 2.0L		51R	440	2014-10	V12 6.0L	54,66	49	830	2014-09	L4 2.0L PR-J0Z	54,57,66,67,70	95R	850
2006	L4 2.0L		51R	500	<b>V8 Vantage</b>					2014-08	L4 2.0L PR-J0R	54,57,66,67,70	94R	640
<b>EL</b>					2014-09	V8 4.7L	54,66	49	830	2014-08	L4 2.0L PR-J1U	54,57,66,67,70	49	760
2005-01	L4 1.7L		51	410	2008-06	V8 4.3L	54,66	49	830	2012-09	L4 2.0L PR-J1N	54,57,66,67,69,70	48	600
2000-97	L4 1.6L		51R	410	<b>Vanquish</b>					2008	V6 3.2L PR-J0R	54,57,66,67,70	94R	640
<b>ILX</b>					2014	V12 6.0L	54,66	49	830	2008	V6 3.2L PR-J1U	54,57,66,67,70	49	760
2014-13	L4 1.5L Hybrid		151R	340	2006-01	V12 6.0L	54,66	49	830	2007-06	V6 3.2L	54,57,66,67,70	94R	640
2014-13	L4 2.0L		51R	410	<b>Virage</b>					2007-06	V6 3.2L Optional	54,57,66,67,70	49	760
2014-13	L4 2.4L		51R	410	2012	V12 6.0L	54,66	49	830	2007-05	L4 2.0L	54,57,66,67,70	94R	640
<b>Integra</b>					<b>AUDI</b>					2007-05	L4 2.0L Optional	54,57,66,67,70	49	760
2001-95	L4 1.8L		51R	410	<b>90</b>					2006-03	L4 1.8L	54,57,66,67,70	94R	640
<b>Legend</b>					<b>90 Quattro</b>					2006-02	L4 1.8L Optional	54,57,66,67,70	49	760
1995	V6 3.2L		24	585	1995	V6 2.8L		41	650	2005-03	V6 3.0L	54,57,66,67,70	94R	640
<b>MDX</b>					<b>A3</b>					2005-02	V6 3.0L Optional	54,57,66,67,70	49	760
2014	V6 3.5L		24F	550	2013-12	L4 2.0L Diesel; PR-J0N,J1L	54,57,66,67,70	47	540	2002-97	L4 1.8L	54,57,66,67,70	48	640
2013-07	V6 3.7L		24F	630	2013	L4 2.0L Diesel; PR-J0L,J1D	54,57,66,67,69,70	48	640	2002-97	L4 1.8L Optional	54,57,66,67,70	94R	640
2006-01	V6 3.5L		24F	550	2013	L4 2.0L Diesel; PR-J2D	54,57,66,67,69,70	48	680	2002	V6 3.0L	54,57,66,67,70	48	640
<b>NSX</b>					2013	L4 2.0L PR-J0L,J1D	54,57,66,67,70	48	640	2002	V6 3.0L Optional	54,57,66,67,70	94R	640
2005-97	V6 3.2L MT		35	435	2013	L4 2.0L PR-J0N,J1L	54,57,66,67,70	47	540	2001-96	V6 2.8L	54,57,66,67,70	48	640
2005-95	V6 3.0L MT		35	435	2013	L4 2.0L PR-J2D	54,57,66,67,69,70	48	680	2001-96	V6 2.8L Optional	54,57,66,67,70	94R	640
1999	V6 3.0L AT		24F	585	2012-11	L4 2.0L Diesel; PR-J2D	54,57,66,67,69,70	48	680	2001-96	V6 2.8L Optional	54,57,66,67,70	94R	720
1999	V6 3.2L AT		24F	585	2012-11	L4 2.0L PR-J0N,J1L	54,57,66,67,70	47	540	1997	L4 1.8L Optional	54,57,66,67,70	47	540
<b>RDX</b>					2012	L4 2.0L Diesel; PR-J0L,J1D	54,57,66,67,70	48	640	1997	V6 2.8L Optional	54,57,66,67,70	47	540
2014-13	V6 3.5L		24F	550	2012	L4 2.0L PR-J0L,J1D	54,57,66,67,70	48	640	<b>A4 allroad</b>				
2012-07	L4 2.3L		35	440	2012	L4 2.0L PR-J2D	54,57,66,67,69,70	48	680	2014-13	L4 2.0L PR-J0B	54,57,66,67,69,70	49	850
<b>RL</b>					2011-10	L4 2.0L Diesel; PR-J0L,J1D	54,57,66,67,70	48	640	2014-13	L4 2.0L PR-J0L	54,57,66,67,70	48	570
2012-09	V6 3.7L	11	24	550	2011	L4 2.0L Diesel; PR-J0N,J1L	54,57,66,67,70	47	540	2014-13	L4 2.0L PR-J0N,J1L	54,57,66,67,70	47	540
2008-05	V6 3.5L	11	24	585	2011	L4 2.0L PR-J0L,J1D	54,57,66,67,70	48	640	2014-13	L4 2.0L PR-J0P	54,57,66,67,69,70	95R	950
2004-96	V6 3.5L		24	550	2011	L4 2.0L PR-J2D	54,57,66,67,69,70	48	680	2014-13	L4 2.0L PR-J0R	54,57,66,67,70	94R	640
<b>RLX</b>					2010	L4 2.0L Diesel; PR-J0L,J1D	54,57,66,67,70	48	640	2014-13	L4 2.0L PR-J0Z	54,57,66,67,70	95R	850
2014	V6 3.5L		24F	550	2010	L4 2.0L PR-J0L,J1D	54,57,66,67,70	48	640	2014-13	L4 2.0L PR-J1N	54,57,66,67,69,70	48	600
<b>RSX</b>					2010	L4 2.0L PR-J2D	54,57,66,67,69,70	48	680	2014-13	L4 2.0L PR-J1U	54,57,66,67,70	49	760
2006-02	L4 2.0L		51R	400	2010	L4 2.0L Diesel; PR-J0N,J1L	54,57,66,67,70	47	540	2014-13	L4 2.0L PR-J2D	54,57,66,67,69,70	48	680
<b>SLX</b>					2010	L4 2.0L Diesel; PR-J2D	54,57,66,67,69,70	48	680	<b>A4 Quattro</b>				
1999-98	V6 3.5L		24	585	2010	L4 2.0L PR-J0N,J1L	54,57,66,67,70	47	540	2014-13	L4 2.0L PR-J0L	54,57,66,67,70	48	570
1999-98	V6 3.5L Optional		27	610	2010	L4 2.0L PR-J0L,J1D	54,57,66,67,70	47	540	2014-13	L4 2.0L PR-J1L	54,57,66,67,70	47	540
1997	V6 3.2L		24	585	2010-09	L4 2.0L PR-J0N,J1L	54,57,66,67,69,70	48	680	2014-09	L4 2.0L PR-J0B	54,57,66,67,69,70	49	850
1997	V6 3.2L Optional		27	610	2010	L4 2.0L Diesel; PR-J2D	54,57,66,67,69,70	48	680	2014-09	L4 2.0L PR-J0P	54,57,66,67,69,70	95R	950
1996	V6 3.2L		27	610	2010	L4 2.0L PR-J0L,J1D	54,57,66,67,70	47	540	2014-09	L4 2.0L PR-J0Z	54,57,66,67,70	95R	850
<b>TL</b>					2010	L4 2.0L Diesel; PR-J2D	54,57,66,67,69,70	48	680	2014-08	L4 2.0L PR-J0R	54,57,66,67,70	94R	640
2014-09	V6 3.7L	11	24F	550	2010	L4 2.0L PR-J0N,J1L	54,57,66,67,70	47	540	2014-08	L4 2.0L PR-J1U	54,57,66,67,70	94R	640
2014-07	V6 3.5L	11	24F	550	2009	L4 2.0L PR-J0L,J1D	54,57,66,67,70	47	540	2014-08	L4 2.0L PR-J1U	54,57,66,67,70	49	760
2008-04	V6 3.2L	11	24F	550	2008-06	L4 2.0L	54,57,66,67,70	47	540	<b>A4 Quattro</b>				
2003-99	V6 3.2L	11	24	550	2008-06	L4 2.0L Optional	54,57,66,67,70	48	640	2014-13	L4 2.0L PR-J0L	54,57,66,67,70	48	570
1998-96	V6 3.2L		25	450	<b>A3 Quattro</b>					2014-13	L4 2.0L PR-J1L	54,57,66,67,70	47	540
1998-95	L5 2.5L		35	450	2013-09	L4 2.0L PR-J0L,J1D	54,57,66,67,70	48	640	2014-13	L4 2.0L PR-J2D	54,57,66,67,69,70	48	680
<b>TSX</b>					2013-09	L4 2.0L PR-J0N,J1L	54,57,66,67,70	47	540	2014-09	L4 2.0L PR-J0B	54,57,66,67,69,70	49	850
2014-10	V6 3.5L		24F	550	2013-09	L4 2.0L PR-J2D	54,57,66,67,69,70	48	680	2014-09	L4 2.0L PR-J0P	54,57,66,67,69,70	95R	950
2014-04	L4 2.4L		51R	430	2009	V6 3.2L PR-J0R	54,57,66,67,70	94R	640	2014-09	L4 2.0L PR-J0Z	54,57,66,67,70	95R	850
<b>ZDX</b>					2008-06	V6 3.2L	54,57,66,67,70	94R	640	2014-08	L4 2.0L PR-J0R	54,57,66,67,70	94R	640
2013-10	V6 3.7L		24F	550	2008-06	V6 3.2L Optional	54,57,66,67,69,70	48	600	2014-08	L4 2.0L PR-J1U	54,57,66,67,70	49	760
<b>ALFA ROMEO</b>					<b>A3 Quattro</b>					<b>A4 Quattro</b>				
<b>164</b>					2013-09	L4 2.0L PR-J0L,J1D	54,57,66,67,70	48	640	2014-13	L4 2.0L PR-J0L	54,57,66,67,70	48	570
1995	V6 3.0L	54	31A	685	2013-09	L4 2.0L PR-J0N,J1L	54,57,66,67,70	47	540	2014-13	L4 2.0L PR-J1L	54,57,66,67,70	47	540
<b>8C</b>					2013-09	L4 2.0L PR-J2D	54,57,66,67,69,70	48	680	2014-09	L4 2.0L PR-J0B	54,57,66,67,69,70	49	850
2008	V8 4.7L	66	24F	580	2009	V6 3.2L PR-J0R	54,57,66,67,70	94R	640	2014-09	L4 2.0L PR-J0P	54,57,66,67,69,70	95R	950
<b>AM GENERAL</b>					2008-06	V6 3.2L	54,57,66,67,70	94R	640	2014-09	L4 2.0L PR-J0Z	54,57,66,67,70	95R	850
<b>Hummer</b>					2008-06	V6 3.2L Optional	54,57,66,67,69,70	48	600	2014-08	L4 2.0L PR-J0R	54,57,66,67,70	94R	640
2001-95	V8 6.5L Diesel	2	78	770	<b>ASTON MARTIN</b>					2014-08	L4 2.0L PR-J1U	54,57,66,67,70	49	760
1996-95	V8 5.7L		78	770	<b>DB7</b>					<b>A4 Quattro</b>				
<b>ASTON MARTIN</b>					2004-00	V12 6.0L	54,66	48	780	2014-13	L4 2.0L PR-J0L	54,57,66,67,70	48	570
<b>DB7</b>					1998-97	L6 3.2L	54,66	48	780	2014-13	L4 2.0L PR-J1L	54,57,66,67,70	47	540

# Passenger Car & Light Truck

YEAR	ENGINE/ OPTIONS	FOOT NOTE	GROUP/ TYPE NO.	O.E. CCA (@0°F)	YEAR	ENGINE/ OPTIONS	FOOT NOTE	GROUP/ TYPE NO.	O.E. CCA (@0°F)	YEAR	ENGINE/ OPTIONS	FOOT NOTE	GROUP/ TYPE NO.	O.E. CCA (@0°F)
<b>AUDI (Cont.)</b>					<b>AUDI (Cont.)</b>					<b>AUDI (Cont.)</b>				
<b>A4 Quattro (Cont.)</b>					<b>A5 Quattro (Cont.)</b>					<b>A6 Quattro (Cont.)</b>				
2012-09	L4 2.0L PR-J1N	54,57,66,67, 69,70	48	600	2010-08	V6 3.2L PR-J0Z	54,57,66,67, 70	95R	850	2014	V6 3.0L Diesel; PR-J0Z	54,57,66,67, 70	95R	850
2009-08	V6 3.2L PR-J0R	54,57,66,67, 70	94R	640	2010-08	V6 3.2L PR-J1U	54,57,66,67, 70	49	760	2014	V6 3.0L Diesel; PR-J1N	54,57,66,67, 69,70	48	600
2009-08	V6 3.2L PR-J1U	54,57,66,67, 70	49	760	2010	V6 3.2L PR-J0B	54,57,66,67, 69,70	49	850	2014	V6 3.0L Diesel; PR-J1U	54,57,66,67, 70	49	760
2009	V6 3.2L PR-J0B	54,57,66,67, 69,70	49	850	2010	V6 3.2L PR-J0L	54,57,66,67, 70	48	570	2014	V6 3.0L Diesel; PR-J2D	54,57,66,67, 69,70	48	680
2009	V6 3.2L PR-J0P	54,57,66,67, 69,70	95R	950	2010	V6 3.2L PR-J0P	54,57,66,67, 69,70	95R	950	2014	V6 3.0L PR-J0B	54,57,66,67, 69,70	49	850
2009	V6 3.2L PR-J0Z	54,57,66,67, 70	95R	850	2010	V6 3.2L PR-J1L	54,57,66,67, 70	47	540	2014	V6 3.0L PR-J0R	54,57,66,67, 70	94R	640
2009	V6 3.2L PR-J1N	54,57,66,67, 69,70	48	600	2010	V6 3.2L PR-J2D	54,57,66,67, 69,70	48	680	2014	V6 3.0L PR-J0Z	54,57,66,67, 70	95R	850
2007-05	L4 2.0L	54,57,66,67, 70	94R	640	<b>A6</b>					2014	V6 3.0L PR-J1N	54,57,66,67, 69,70	48	600
2007-05	L4 2.0L Optional	54,57,66,67, 70	49	760	2014-12	L4 2.0L PR-J0B	54,57,66,67, 69,70	49	850	2014	V6 3.0L PR-J1U	54,57,66,67, 70	49	760
2007-05	V6 3.2L	54,57,66,67, 70	94R	640	2014-12	L4 2.0L PR-J0L	54,57,66,67, 70	48	640	2014	V6 3.0L PR-J2D	54,57,66,67, 70	48	640
2007-05	V6 3.2L Optional	54,57,66,67, 70	49	760	2014-12	L4 2.0L PR-J0P	54,57,66,67, 69,70	95R	950	2014	V6 3.0L PR-J2D	54,57,66,67, 69,70	48	680
2006-03	V6 3.0L	54,57,66,67, 70	94R	640	2014-12	L4 2.0L PR-J0R	54,57,66,67, 70	94R	640	2013-11	V6 3.0L PR-J0B	54,57,66,67, 69,70	49	850
2006-02	V6 3.0L Optional	54,57,66,67, 70	49	760	2014-12	L4 2.0L PR-J0Z	54,57,66,67, 70	95R	850	2013-11	V6 3.0L PR-J0L	54,57,66,67, 70	48	640
2005-03	L4 1.8L	54,57,66,67, 70	94R	640	2014-12	L4 2.0L PR-J1N	54,57,66,67, 69,70	48	600	2013-11	V6 3.0L PR-J0R	54,57,66,67, 70	94R	640
2005-02	L4 1.8L Optional	54,57,66,67, 70	49	760	2014-12	L4 2.0L PR-J1U	54,57,66,67, 70	49	760	2013-11	V6 3.0L PR-J0Z	54,57,66,67, 70	95R	850
2002-99	L4 1.8L Optional	54,57,66,67, 70	94R	640	2014-12	L4 2.0L PR-J2D	54,57,66,67, 69,70	48	680	2013-11	V6 3.0L PR-J1N	54,57,66,67, 69,70	48	600
2002-99	L4 1.8L Optional	54,57,66,67, 70	94R	720	2011	V6 3.2L PR-J0B	54,57,66,67, 69,70	49	850	2013-11	V6 3.0L PR-J1U	54,57,66,67, 70	49	760
2002-97	L4 1.8L	54,57,66,67, 70	48	640	2011	V6 3.2L PR-J0L	54,57,66,67, 70	48	640	2013-11	V6 3.0L PR-J2D	54,57,66,67, 69,70	48	680
2002	V6 3.0L	54,57,66,67, 70	48	640	2011	V6 3.2L PR-J0P	54,57,66,67, 69,70	95R	950	2011	V8 4.2L PR-J0B	54,57,66,67, 69,70	49	850
2002	V6 3.0L Optional	54,57,66,67, 70	94R	640	2011	V6 3.2L PR-J0R	54,57,66,67, 70	94R	640	2011	V8 4.2L PR-J0L	54,57,66,67, 70	48	640
2002	V6 3.0L Optional	54,57,66,67, 70	94R	720	2011	V6 3.2L PR-J0Z	54,57,66,67, 70	95R	850	2011	V8 4.2L PR-J0P	54,57,66,67, 69,70	95R	950
2001-99	V6 2.8L Optional	54,57,66,67, 70	94R	640	2011	V6 3.2L PR-J1N	54,57,66,67, 69,70	48	600	2011	V8 4.2L PR-J0R	54,57,66,67, 70	94R	640
2001-99	V6 2.8L Optional	54,57,66,67, 70	94R	720	2011	V6 3.2L PR-J1U	54,57,66,67, 70	49	760	2011	V8 4.2L PR-J0Z	54,57,66,67, 70	95R	850
2001-98	V6 2.8L	54,57,66,67, 70	48	640	2011	V6 3.2L PR-J2D	54,57,66,67, 69,70	48	680	2011	V8 4.2L PR-J1N	54,57,66,67, 69,70	48	600
1997-96	V6 2.8L Optional	54,57,66,67, 70	48	640	2010-06	V6 3.2L	54,57,66,67, 70	48	570	2011	V8 4.2L PR-J1U	54,57,66,67, 70	49	760
1996	V6 2.8L	54,57,66,67, 70	47	540	2010-06	V6 3.2L Optional	54,57,66,67, 70	49	760	2011	V8 4.2L PR-J2D	54,57,66,67, 69,70	48	680
1996	V6 2.8L Optional	54,57,66,67, 70	94R	640	2010-06	V6 3.2L Optional	54,57,66,67, 70	49	850	2010-09	V6 3.0L	54,57,66,67, 70	48	570
1996	V6 2.8L Optional	54,57,66,67, 70	94R	720	2010-06	V6 3.2L Optional	54,57,66,67, 70	94R	640	2010-09	V6 3.0L Optional	54,57,66,67, 70	49	760
<b>A5</b>					2010-06	V6 3.2L Optional	54,57,66,67, 70	95R	850	2010-09	V6 3.0L Optional	54,57,66,67, 69,70	49	850
2014-12	L4 2.0L PR-J1N	54,57,66,67, 69,70	48	600	2004-02	V6 3.0L	54,57,66,67, 70	48	640	2010-09	V6 3.0L Optional	54,57,66,67, 70	94R	640
2014-10	L4 2.0L PR-J0B	54,57,66,67, 69,70	49	850	2004-02	V6 3.0L Optional	54,57,66,67, 70	49	760	2010-09	V6 3.0L Optional	54,57,66,67, 70	95R	850
2014-10	L4 2.0L PR-J0L	54,57,66,67, 70	48	570	2004-02	V6 3.0L Optional	54,57,66,67, 70	94R	640	2010-05	V8 4.2L	54,57,66,67, 70	48	570
2014-10	L4 2.0L PR-J0P	54,57,66,67, 69,70	95R	950	2004-02	V6 3.0L Optional	54,57,66,67, 70	94R	720	2010-05	V8 4.2L Optional	54,57,66,67, 69,70	49	850
2014-10	L4 2.0L PR-J0R	54,57,66,67, 70	94R	640	2001-99	V6 2.8L	54	48	570	2010-05	V8 4.2L Optional	54,57,66,67, 70	95R	850
2014-10	L4 2.0L PR-J0Z	54,57,66,67, 70	95R	850	1998-95	V6 2.8L	54	41	650	2010-02	V8 4.2L Optional	54,57,66,67, 70	49	760
2014-10	L4 2.0L PR-J1L	54,57,66,67, 70	47	540	<b>A6 Quattro</b>					2010-02	V8 4.2L Optional	54,57,66,67, 70	94R	640
2014-10	L4 2.0L PR-J1U	54,57,66,67, 70	49	760	2014-13	L4 2.0L PR-J0B	54,57,66,67, 69,70	49	850	2010-02	V8 4.2L Optional	54,57,66,67, 70	49	760
2014-10	L4 2.0L PR-J2D	54,57,66,67, 69,70	48	680	2014-13	L4 2.0L PR-J0L	54,57,66,67, 70	48	640	2008-05	V6 3.2L	54,57,66,67, 70	48	570
<b>A5 Quattro</b>					2014-13	L4 2.0L PR-J0P	54,57,66,67, 69,70	95R	950	2008-05	V6 3.2L Optional	54,57,66,67, 70	49	760
2014-12	L4 2.0L PR-J1N	54,57,66,67, 69,70	48	600	2014-13	L4 2.0L PR-J0R	54,57,66,67, 70	94R	640	2008-05	V6 3.2L Optional	54,57,66,67, 69,70	49	850
2014-10	L4 2.0L PR-J0B	54,57,66,67, 69,70	49	850	2014-13	L4 2.0L PR-J0Z	54,57,66,67, 70	95R	850	2008-05	V6 3.2L Optional	54,57,66,67, 70	94R	640
2014-10	L4 2.0L PR-J0L	54,57,66,67, 70	48	570	2014-13	L4 2.0L PR-J1N	54,57,66,67, 69,70	48	600	2008-05	V6 3.2L Optional	54,57,66,67, 70	95R	850
2014-10	L4 2.0L PR-J0P	54,57,66,67, 69,70	95R	950	2014-13	L4 2.0L PR-J1U	54,57,66,67, 70	49	760	2004-02	V6 2.7L Turbo	54,57,66,67, 70	48	640
2014-10	L4 2.0L PR-J0R	54,57,66,67, 70	94R	640	2014-13	L4 2.0L PR-J2D	54,57,66,67, 69,70	48	680	2004-02	V6 2.7L Turbo, Optional	54,57,66,67, 70	49	760
2014-10	L4 2.0L PR-J0Z	54,57,66,67, 70	95R	850	2014-11	V6 3.0L PR-J0P	54,57,66,67, 69,70	95R	950	2004-02	V6 2.7L Turbo, Optional	54,57,66,67, 70	94R	640
2014-10	L4 2.0L PR-J1L	54,57,66,67, 70	47	540	2014	V6 3.0L Diesel; PR-J0B	54,57,66,67, 69,70	49	850	2004-02	V6 2.7L Turbo, Optional	54,57,66,67, 70	94R	720
2014-10	L4 2.0L PR-J1U	54,57,66,67, 70	49	760	2014	V6 3.0L Diesel; PR-J0L	54,57,66,67, 70	48	640	2004-02	V6 3.0L	54,57,66,67, 70	48	640
2014-10	L4 2.0L PR-J2D	54,57,66,67, 69,70	48	680	2014	V6 3.0L Diesel; PR-J0P	54,57,66,67, 69,70	95R	950	2004-02	V6 3.0L Optional	54,57,66,67, 70	49	760
2010-08	V6 3.2L PR-J0R	54,57,66,67, 70	94R	640	2014	V6 3.0L Diesel; PR-J0R	54,57,66,67, 70	94R	640					

# Passenger Car & Light Truck

YEAR	ENGINE/ OPTIONS	FOOT NOTE	GROUP/ TYPE NO.	O.E. CCA (@0°F)	YEAR	ENGINE/ OPTIONS	FOOT NOTE	GROUP/ TYPE NO.	O.E. CCA (@0°F)	YEAR	ENGINE/ OPTIONS	FOOT NOTE	GROUP/ TYPE NO.	O.E. CCA (@0°F)
<b>AUDI (Cont.)</b>					<b>AUDI (Cont.)</b>					<b>AUDI (Cont.)</b>				
<b>A6 Quattro (Cont.)</b>					<b>A8 Quattro (Cont.)</b>					<b>Q5 (Cont.)</b>				
2004-02	V6 3.0L Optional	54,57,66,67,70	94R	640	2014	V8 4.0L PR-J1N	54,57,66,67,69,70	48	600	2014	V6 3.0L PR-JOR	54,57,66,67,70	94R	640
2004-02	V6 3.0L Optional	54,57,66,67,70	94R	720	2014	W12 6.3L PR-J1N	54,57,66,67,69,70	48	600	2014	V6 3.0L PR-JOZ	54,57,66,67,70	95R	850
2004-02	V8 4.2L	54,57,66,67,70	48	640	2013-12	W12 6.3L PR-0K1	54,57,66,67,69,70	48	600	2013	V6 3.0L PR-JOP	54,57,66,67,69,70	95R	950
2004-02	V8 4.2L Optional	54,57,66,67,70	94R	720	2013	V6 3.0L PR-0K1	54,57,66,67,69,70	48	600	2013	V6 3.0L PR-JOR	54,57,66,67,70	94R	640
2001-99	V6 2.8L	54	48	570	2013	V6 3.0L PR-JOP	54,57,66,67,69,70	95R	950	2013	V6 3.0L PR-JOZ	54,57,66,67,70	95R	850
2001-00	V6 2.7L Turbo	54	94R	640	2013	V8 4.0L PR-0K1	54,57,66,67,69,70	48	600	2012-11	L4 2.0L PR-JON,J1L	54,57,66,67,70	47	540
2001-00	V8 4.2L	54	49	850	2012-10	V8 4.2L PR-0K1	54,57,66,67,69,70	48	600	2012-09	V6 3.2L PR-JOB	54,57,66,67,69,70	49	850
1998-95	V6 2.8L	54	41	650	2012-10	V8 4.2L PR-JOB	54,57,66,67,69,70	49	850	2012-09	V6 3.2L PR-JOL	54,57,66,67,70	48	570
<b>A7 Quattro</b>					2012-10	V8 4.2L PR-JOP	54,57,66,67,69,70	95R	950	2012-09	V6 3.2L PR-JON,J1L	54,57,66,67,70	47	540
2014-12	V6 3.0L PR-JOP	54,57,66,67,69,70	95R	950	2012-10	V8 4.2L PR-JOZ	54,57,66,67,69,70	95R	950	2012-09	V6 3.2L PR-JOP	54,57,66,67,69,70	95R	950
2014-12	V6 3.0L PR-JOZ	54,57,66,67,69,70	95R	850	2012-10	V8 4.2L PR-J1U	54,57,66,67,70	49	760	2012-09	V6 3.2L PR-JOR	54,57,66,67,70	94R	640
2014	V6 3.0L Diesel: PR-JOB	54,57,66,67,69,70	49	850	2009-08	V8 4.2L Optional	54,57,66,67,69,70	49	850	2012-09	V6 3.2L PR-JOZ	54,57,66,67,70	95R	850
2014	V6 3.0L Diesel: PR-JOP	54,57,66,67,69,70	95R	950	2009-08	W12 6.0L Optional	54,57,66,67,69,70	49	850	2012-09	V6 3.2L PR-J1N	54,57,66,67,69,70	48	600
2014	V6 3.0L Diesel: PR-JOR	54,57,66,67,70	94R	640	2009-05	W12 6.0L	54,57,66,67,70	95R	850	2012-09	V6 3.2L PR-J1U	54,57,66,67,70	49	760
2014	V6 3.0L Diesel: PR-JOZ	54,57,66,67,69,70	95R	850	2009-04	V8 4.2L	54,57,66,67,70	95R	850	2012-09	V6 3.2L PR-J2D	54,57,66,67,69,70	48	680
2014	V6 3.0L Diesel: PR-J1N	54,57,66,67,70	49	760	2003-97	V8 4.2L	54	49	850	<b>Q7</b>				
2014	V6 3.0L Diesel: PR-J1U	54,57,66,67,70	49	760	2003-00	V8 4.2L Optional	54	95R	850	2014-11	V6 3.0L	54,57,66,67,70	94R	640
2014	V6 3.0L Diesel: PR-J2D	54,57,66,67,69,70	48	680	<b>Allroad Quattro</b>					2014-11	V6 3.0L Optional	54,57,66,67,70	49	760
2014	V6 3.0L PR-J0B	54,57,66,67,69,70	49	850	2005-04	V6 2.7L	54	94R	650	2014-11	V6 3.0L Optional	54,57,66,67,69,70	49	850
2014	V6 3.0L PR-J0R	54,57,66,67,70	94R	640	2005-03	V8 4.2L	54	49	850	2014-11	V6 3.0L Optional	54,57,66,67,69,70	95R	850
2014	V6 3.0L PR-J1N	54,57,66,67,69,70	48	600	2003	V6 2.7L	54	49	850	2014-11	V6 3.0L Optional	54,57,66,67,70	95R	850
2014	V6 3.0L PR-J1U	54,57,66,67,70	49	760	2002-01	V6 2.7L	54	94R	640	2014-11	V6 3.0L Optional	54,57,66,67,69,70	95R	950
2014	V6 3.0L PR-J2D	54,57,66,67,69,70	48	680	<b>Cabriolet</b>					2014-10	V6 3.0L Diesel	54,57,66,67,70	94R	640
2013-12	V6 3.0L PR-J0B	54,57,66,67,69,70	49	850	1998-95	V6 2.8L		41	650	2014-10	V6 3.0L Diesel, Optional	54,57,66,67,70	49	760
2013-12	V6 3.0L PR-J0R	54,57,66,67,70	94R	640	<b>Q5</b>					2014-10	V6 3.0L Diesel, Optional	54,57,66,67,69,70	49	850
2013-12	V6 3.0L PR-J1N	54,57,66,67,69,70	48	600	2014-13	L4 2.0L PR-J1L	54,57,66,67,70	47	540	2014-10	V6 3.0L Diesel, Optional	54,57,66,67,69,70	95R	950
2013-12	V6 3.0L PR-J1U	54,57,66,67,70	49	760	2014-13	V6 3.0L PR-J0B	54,57,66,67,69,70	49	850	2014-10	V6 3.0L Diesel, Optional	54,57,66,67,69,70	95R	850
2013-12	V6 3.0L PR-J2D	54,57,66,67,69,70	48	680	2014-13	V6 3.0L PR-JOL	54,57,66,67,70	48	570	2014-09	V6 3.0L Diesel, Optional	54,57,66,67,70	95R	850
<b>A8</b>					2014-13	V6 3.0L PR-J1L	54,57,66,67,70	47	540	2010-07	V6 3.6L Optional	54,57,66,67,70	95R	850
1999-97	V8 3.7L	54	49	850	2014-13	V6 3.0L PR-J1N	54,57,66,67,69,70	48	600	2010-07	V8 4.2L Optional	54,57,66,67,70	95R	850
<b>A8 Quattro</b>					2014-13	V6 3.0L PR-J1U	54,57,66,67,70	49	760	2010	V6 3.6L	54,57,66,67,70	94R	640
2014-13	V6 3.0L PR-J0B	54,57,66,67,69,70	49	850	2014-13	V6 3.0L PR-J2D	54,57,66,67,69,70	48	680	2010	V6 3.6L Optional	54,57,66,67,70	49	760
2014-13	V6 3.0L PR-JOZ	54,57,66,67,70	95R	850	2014-11	L4 2.0L PR-JOB	54,57,66,67,69,70	49	850	2010	V6 3.6L Optional	54,57,66,67,69,70	49	850
2014-13	V6 3.0L PR-J1U	54,57,66,67,70	49	760	2014-11	L4 2.0L PR-JOL	54,57,66,67,69,70	48	570	2010	V6 3.6L Optional	54,57,66,67,69,70	95R	950
2014-13	V8 4.0L PR-J0B	54,57,66,67,69,70	49	850	2014-11	L4 2.0L PR-JOP	54,57,66,67,69,70	95R	950	2010	V6 3.6L Optional	54,57,66,67,69,70	95R	950
2014-13	V8 4.0L PR-J0R	54,57,66,67,69,70	95R	950	2014-11	L4 2.0L PR-JOR	54,57,66,67,70	94R	640	2010	V8 4.2L	54,57,66,67,70	94R	640
2014-13	V8 4.0L PR-JOZ	54,57,66,67,70	95R	850	2014-11	L4 2.0L PR-JOZ	54,57,66,67,70	95R	850	2010	V8 4.2L Optional	54,57,66,67,70	49	760
2014-13	V8 4.0L PR-J1U	54,57,66,67,70	49	760	2014-11	L4 2.0L PR-J1N	54,57,66,67,69,70	48	600	2010	V8 4.2L Optional	54,57,66,67,69,70	49	850
2014-12	W12 6.3L PR-J0B	54,57,66,67,69,70	49	850	2014-11	L4 2.0L PR-J1U	54,57,66,67,70	49	760	2010	V8 4.2L Optional	54,57,66,67,69,70	95R	950
2014-12	W12 6.3L PR-JOP	54,57,66,67,69,70	95R	950	2014-11	L4 2.0L PR-J2D	54,57,66,67,69,70	48	680	2009-07	V6 3.6L	54,57,66,67,70	49	760
2014-12	W12 6.3L PR-JOZ	54,57,66,67,70	95R	850	2014	V6 3.0L Diesel: PR-JOB	54,57,66,67,69,70	49	850	2009-07	V8 4.2L	54,57,66,67,70	49	760
2014-12	W12 6.3L PR-J1U	54,57,66,67,70	49	760	2014	V6 3.0L Diesel: PR-JOL	54,57,66,67,70	48	570	2009	V6 3.0L Diesel	54,57,66,67,70	49	760
2014	V6 3.0L Diesel: PR-JOB	54,57,66,67,69,70	49	850	2014	V6 3.0L Diesel: PR-JOP	54,57,66,67,69,70	95R	950	<b>R8</b>				
2014	V6 3.0L Diesel: PR-JOP	54,57,66,67,69,70	95R	950	2014	V6 3.0L Diesel: PR-JOR	54,57,66,67,70	94R	640	2014	V10 5.2L PR-J2D	54,57,66,67,69,70	48	680
2014	V6 3.0L Diesel: PR-JOZ	54,57,66,67,70	95R	850	2014	V6 3.0L Diesel: PR-JOZ	54,57,66,67,70	95R	850	2014	V8 4.2L PR-J2D	54,57,66,67,69,70	48	680
2014	V6 3.0L Diesel: PR-J1N	54,57,66,67,69,70	48	600	2014	V6 3.0L Diesel: PR-J1L	54,57,66,67,70	47	540	2012-10	V10 5.2L PR-JOL	54,57,66,67,70	48	570
2014	V6 3.0L Diesel: PR-J1U	54,57,66,67,70	49	760	2014	V6 3.0L Diesel: PR-J1N	54,57,66,67,69,70	48	600	2012-10	V10 5.2L PR-JOZ	54,57,66,67,70	95R	850
2014	V6 3.0L PR-J0P	54,57,66,67,69,70	95R	950	2014	V6 3.0L Diesel: PR-J1U	54,57,66,67,70	49	760	2012-10	V10 5.2L PR-J2D	54,57,66,67,69,70	48	680
2014	V6 3.0L PR-J1N	54,57,66,67,69,70	48	600	2014	V6 3.0L Diesel: PR-J2D	54,57,66,67,69,70	48	680	2012-08	V8 4.2L PR-JOL	54,57,66,67,70	48	570
2014	V6 3.0L PR-J1U	54,57,66,67,70	49	760	2014	V6 3.0L PR-JOP	54,57,66,67,69,70	95R	950	2012-08	V8 4.2L PR-JOZ	54,57,66,67,70	95R	850
2014	V6 3.0L PR-J2D	54,57,66,67,69,70	48	680						2012-08	V8 4.2L PR-J2D	54,57,66,67,69,70	48	680

# Passenger Car & Light Truck

YEAR	ENGINE/ OPTIONS	FOOT NOTE	GROUP/ TYPE NO.	O.E. CCA (@0°F)	YEAR	ENGINE/ OPTIONS	FOOT NOTE	GROUP/ TYPE NO.	O.E. CCA (@0°F)	YEAR	ENGINE/ OPTIONS	FOOT NOTE	GROUP/ TYPE NO.	O.E. CCA (@0°F)
<b>AUDI (Cont.)</b>					<b>AUDI (Cont.)</b>					<b>AUDI (Cont.)</b>				
<b>RS4</b>					<b>S5 (Cont.)</b>					<b>TT</b>				
2008-07	V8 4.2L	54,57,66,67, 69,70	49	850	2012-09	V8 4.2L PR-J0P	54,57,66,67, 69,70	95R	950	2009-08	L4 2.0L	54,66	47	480
<b>RS5</b>					2012-09	V8 4.2L PR-J2D	54,57,66,67, 69,70	48	680	2006-00	L4 1.8L	45	N/A	480
2014-13	V8 4.2L PR-J0B	54,57,66,67, 69,70	49	850	2012-08	V8 4.2L PR-J0R	54,57,66,67, 70	94R	640	<b>TT Quattro</b>				
2014-13	V8 4.2L PR-J0P	54,57,66,67, 69,70	95R	950	2012-08	V8 4.2L PR-J0Z	54,57,66,67, 70	95R	850	2014-09	L4 2.0L	54,66	47	480
2014-13	V8 4.2L PR-J0Z	54,57,66,67, 70	95R	850	2012-08	V8 4.2L PR-J1U	54,57,66,67, 70	49	760	2013-12	L5 2.5L	54,66	47	480
2014-13	V8 4.2L PR-J1U	54,57,66,67, 70	49	760	2012	V8 4.2L PR-J1N	54,57,66,67, 69,70	48	600	2009-08	V6 3.2L	45	94R	650
2014	V8 4.2L PR-J2D	54,57,66,67, 69,70	48	680	2009	V8 4.2L PR- J0N,J1L	54,57,66,67, 70	47	540	2006-04	V6 3.2L	45	N/A	480
<b>RS6</b>					<b>S6</b>					<b>AVANTI</b>				
2004-03	V8 4.2L	54	49	850	2014-13	V8 4.0L PR-J0B	54,57,66,67, 69,70	49	850	<b>Avanti</b>				
<b>RS7</b>					2014-13	V8 4.0L PR-J0L	54,57,66,67, 70	48	640	2007-05	V8 4.6L		96R	590
2014	V8 4.0L PR-J0B	54,57,66,67, 69,70	49	850	2014-13	V8 4.0L PR-J0P	54,57,66,67, 69,70	95R	950	<b>BENTLEY</b>				
2014	V8 4.0L PR-J0P	54,57,66,67, 69,70	95R	950	2014-13	V8 4.0L PR-J0R	54,57,66,67, 70	94R	640	<b>Arnage</b>				
2014	V8 4.0L PR-J0R	54,57,66,67, 70	94R	640	2014-13	V8 4.0L PR-J0Z	54,57,66,67, 70	95R	850	2009-08	V8 6.8L Auxiliary - Left Side	54	34	750
2014	V8 4.0L PR-J0Z	54,57,66,67, 70	95R	850	2014-13	V8 4.0L PR-J1N	54,57,66,67, 69,70	48	600	2009-08	V8 6.8L Primary Battery - Right Side	54	91	700
2014	V8 4.0L PR-J1N	54,57,66,67, 69,70	48	600	2014-13	V8 4.0L PR-J1U	54,57,66,67, 70	49	760	2007-06	V8 6.8L		91	700
2014	V8 4.0L PR-J1U	54,57,66,67, 70	49	760	2014-13	V8 4.0L PR-J2D	54,57,66,67, 69,70	48	680	2005-00	V8 6.7L		91	700
2014	V8 4.0L PR-J2D	54,57,66,67, 69,70	48	680	2011	V10 5.2L PR-J0B	54,57,66,67, 69,70	49	850	2001-99	V8 4.4L		91	700
<b>S4</b>					2011	V10 5.2L PR-J0L	54,57,66,67, 70	48	640	<b>Azure</b>				
2014-13	V6 3.0L PR-J0L	54,57,66,67, 70	48	570	2011	V10 5.2L PR-J0P	54,57,66,67, 69,70	95R	950	2010-08	V8 6.8L Auxiliary - Left Side	54	34	750
2014-13	V6 3.0L PR-J1L	54,57,66,67, 70	47	540	2011	V10 5.2L PR-J0R	54,57,66,67, 70	94R	640	2010-08	V8 6.8L Primary Battery - Right Side	54	91	700
2014-13	V6 3.0L PR-J2D	54,57,66,67, 69,70	48	680	2011	V10 5.2L PR-J0Z	54,57,66,67, 70	95R	850	2007-06	V8 6.8L		91	700
2014-10	V6 3.0L PR-J0B	54,57,66,67, 69,70	49	850	2011	V10 5.2L PR-J1N	54,57,66,67, 69,70	48	600	2003-96	V8 6.7L		91	700
2014-10	V6 3.0L PR-J0P	54,57,66,67, 69,70	95R	950	2011	V10 5.2L PR-J1U	54,57,66,67, 70	49	760	<b>Brooklands</b>				
2014-10	V6 3.0L PR-J0R	54,57,66,67, 70	94R	640	2011	V10 5.2L PR-J2D	54,57,66,67, 69,70	48	680	2009-08	V8 6.8L Auxiliary - Left Side	54	34	750
2014-10	V6 3.0L PR-J0Z	54,57,66,67, 70	95R	850	2010-07	V10 5.2L	54,57,66,67, 70	48	570	2009-08	V8 6.8L Primary Battery - Right Side	54	91	700
2014-10	V6 3.0L PR-J1U	54,57,66,67, 69,70	49	760	2010-07	V10 5.2L Optional	54,57,66,67, 70	49	760	1998-95	V8 6.7L		91	700
2012-10	V6 3.0L PR-J1N	54,57,66,67, 69,70	48	600	2010-07	V10 5.2L Optional	54,57,66,67, 69,70	49	850	<b>Continental</b>				
2009-08	V8 4.2L PR-J0R	54,57,66,67, 70	94R	640	2010-07	V10 5.2L Optional	54,57,66,67, 70	94R	640	2014-13	V8 4.0L Auxiliary - Left Side	54,66	49	850
2009-08	V8 4.2L PR-J1U	54,57,66,67, 70	49	760	2010-07	V10 5.2L Optional	54,57,66,67, 70	95R	850	2014-13	V8 4.0L Primary Battery - Right Side	54,66	47	610
2009	V8 4.2L PR-J0B	54,57,66,67, 69,70	49	850	2010-07	V10 5.2L Optional	54,57,66,67, 70	94R	640	2014-09	W12 6.0L Auxiliary - Left Side	54,66	49	850
2009	V8 4.2L PR-J0P	54,57,66,67, 69,70	95R	950	2010-07	V10 5.2L Optional	54,57,66,67, 70	95R	850	2014-09	W12 6.0L Primary Battery - Right Side	54,66	47	610
2009	V8 4.2L PR-J0Z	54,57,66,67, 70	95R	850	2003-02	V8 4.2L	54	49	720	2008-04	W12 6.0L Auxiliary - Left Side		49	900
2009	V8 4.2L PR-J1N	54,57,66,67, 69,70	48	600	1997-95	L5 2.2L	54	41	650	2008-04	W12 6.0L Primary Battery - Right Side		47	650
2007-04	V8 4.2L	54,57,66,67, 70	94R	640	<b>S7</b>					2003-98	V8 6.7L		24	650
2007-04	V8 4.2L Optional	54,57,66,67, 70	49	760	2014-13	V8 4.0L PR-J0B	54,57,66,67, 69,70	49	850	2003	W12 6.0L		24	650
2002	V6 2.7L Turbo	54	94R	640	2014-13	V8 4.0L PR-J0P	54,57,66,67, 69,70	95R	950	1997	V8 6.8L		24	650
2001-00	V6 2.7L	54	48	570	2014-13	V8 4.0L PR-J0R	54,57,66,67, 70	94R	640	1996-95	V8 6.7L		24	650
<b>S5</b>					2014-13	V8 4.0L PR-J0Z	54,57,66,67, 70	95R	850	<b>Mulsanne</b>				
2014-12	V6 3.0L PR-J1N	54,57,66,67, 69,70	48	600	2014-13	V8 4.0L PR-J0Z	54,57,66,67, 70	95R	850	2014-11	V8 6.8L Auxiliary - Left Side	54,66	49	850
2014-10	V6 3.0L PR-J0B	54,57,66,67, 69,70	49	850	2014-13	V8 4.0L PR-J1N	54,57,66,67, 69,70	48	600	2014-11	V8 6.8L Primary Battery - Right Side	54,66	47	610
2014-10	V6 3.0L PR-J0L	54,57,66,67, 70	48	570	2014-13	V8 4.0L PR-J1U	54,57,66,67, 70	49	760	<b>Turbo R</b>				
2014-10	V6 3.0L PR-J0P	54,57,66,67, 69,70	95R	950	2014-13	V8 4.0L PR-J2D	54,57,66,67, 69,70	48	680	1998-95	V8 6.7L		48	700
2014-10	V6 3.0L PR-J0R	54,57,66,67, 70	94R	640	<b>S8</b>					<b>BMW</b>				
2014-10	V6 3.0L PR-J0Z	54,57,66,67, 70	95R	850	2014-13	V8 4.0L PR-J0B	54,57,66,67, 69,70	49	850	<b>1 Series M</b>				
2014-10	V6 3.0L PR-J1L	54,57,66,67, 70	47	540	2014-13	V8 4.0L PR-J0P	54,57,66,67, 69,70	95R	950	2011	L6 3.0L	54,66,67,69	48	760
2014-10	V6 3.0L PR-J1U	54,57,66,67, 70	49	760	2014-13	V8 4.0L PR-J0Z	54,57,66,67, 70	95R	850	<b>128i</b>				
2014-10	V6 3.0L PR-J2D	54,57,66,67, 69,70	48	680	2014-13	V8 4.0L PR-J0Z	54,57,66,67, 70	95R	850	2013-08	L6 3.0L	54,57,66,67, 69	48	570
2012-10	V8 4.2L PR-J1L	54,57,66,67, 70	47	540	2014-13	V8 4.0L PR-J1U	54,57,66,67, 70	49	760	2013-08	L6 3.0L Optional	54,57,66,67, 69	48	760
2012-09	V8 4.2L PR-J0B	54,57,66,67, 69,70	49	850	2014	V8 4.0L PR-J1N	54,57,66,67, 69,70	48	600	2013-08	L6 3.0L Optional	54,57,66,67, 69	49	720
2012-09	V8 4.2L PR-J0L	54,57,66,67, 70	48	570	2013	V8 4.0L PR-0K1	54,57,66,67, 69,70	48	600	2013-08	L6 3.0L Optional	54,57,66,67, 69	49	900
					2009-08	V10 5.2L Optional	54,57,66,67, 69,70	49	850	2013-08	L6 3.0L Optional	54,57,66,67, 69	94R	640
					2009-07	V10 5.2L	54,57,66,67, 70	95R	850	<b>135i</b>				
					2003-02	V8 4.2L	54	49	720	2013-08	L6 3.0L	54,57,66,67, 69	48	570
					2001	V8 4.2L	54	49	850	2013-08	L6 3.0L Optional	54,57,66,67, 69	48	760
										2013-08	L6 3.0L Optional	54,57,66,67, 69	49	720

# Passenger Car & Light Truck

YEAR	ENGINE/ OPTIONS	FOOT NOTE	GROUP/ TYPE NO.	O.E. CCA (@0°F)	YEAR	ENGINE/ OPTIONS	FOOT NOTE	GROUP/ TYPE NO.	O.E. CCA (@0°F)	YEAR	ENGINE/ OPTIONS	FOOT NOTE	GROUP/ TYPE NO.	O.E. CCA (@0°F)
<b>BMW (Cont.)</b>					<b>BMW (Cont.)</b>					<b>BMW (Cont.)</b>				
<b>135i (Cont.)</b>					<b>325i (Cont.)</b>					<b>328i (Cont.)</b>				
2013-08	L6 3.0L Optional	54,57,66,67, 69	49	850	2006	L6 3.0L Optional	54,57,66,67	94R	640	2013-07	L6 3.0L Optional	54,57,66,67, 69	49	850
2013-08	L6 3.0L Optional	54,57,66,67, 69	49	900	2005-04	L6 2.5L Eng. Code M54	54,57,66,67	94R	640	2013-07	L6 3.0L Optional	54,57,66,67, 69	49	900
2013-08	L6 3.0L Optional	54,57,66,67	94R	640	2005-04	L6 2.5L Eng. Code M54 Optional	54,57,66,67	48	570	2013-07	L6 3.0L Optional	54,57,66,67	94R	640
<b>135is</b>					2005-04	L6 2.5L Eng. Code N52	54,57,66,67	48	570	2000-99	L6 2.8L	54	94R	765
2013	L6 3.0L	54,57,66,67	48	570	2005-04	L6 2.5L Eng. Code N52 Optional	54,57,66,67, 69	48	760	1998-96	L6 2.8L Conv.	34,54	92	575
2013	L6 3.0L Optional	54,57,66,67, 69	48	760	2005-04	L6 2.5L Eng. Code N52 Optional	54,57,66,67, 69	48	760	1998-96	L6 2.8L ex. Conv.	54	92	650
2013	L6 3.0L Optional	54,57,66,67	49	720	2005-04	L6 2.5L Eng. Code N52 Optional	54,57,66,67	49	720	<b>328i GT xDrive</b>				
2013	L6 3.0L Optional	54,57,66,67, 69	49	850	2005-04	L6 2.5L Eng. Code N52 Optional	54,57,66,67, 69	49	850	2014	L4 2.0L	54,57,66,67, 69	49	850
2013	L6 3.0L Optional	54,57,66,67, 69	49	900	2005-04	L6 2.5L Eng. Code N52 Optional	54,57,66,67, 69	49	900	<b>328i xDrive</b>				
2013	L6 3.0L Optional	54,57,66,67	94R	640	2005-04	L6 2.5L Eng. Code N52 Optional	54,57,66,67, 69	49	900	2014-13	L4 2.0L	54,57,66,67, 69	94R	800
<b>228i</b>					2005-04	L6 2.5L Eng. Code N52 Optional	54,57,66,67, 69	94R	640	2014-13	L4 2.0L Optional	54,57,66,67, 69	49	850
2014	L4 2.0L	54,57,66,67, 69	94R	800	2004	L6 2.5L Eng. Code M56	54,57,66,67, 69	49	900	2013-09	L6 3.0L	54,57,66,67	48	570
2014	L4 2.0L Optional	54,57,66,67, 69	49	850	2004	L6 2.5L Eng. Code M56 Optional	54,57,66,67, 69	49	850	2013-09	L6 3.0L Optional	54,57,66,67, 69	48	760
<b>318i</b>					2003-02	L6 2.5L ex. SULEV	54,57,66,67	94R	640	2013-09	L6 3.0L Optional	54,57,66,67	49	720
1999-98	L4 1.9L	54	91	600	2003-02	L6 2.5L ex. SULEV Optional	54,57,66,67	48	570	2013-09	L6 3.0L Optional	54,57,66,67, 69	49	850
1997-96	L4 1.9L Conv.	34,54	92	575	2003-02	L6 2.5L SULEV	54,57,66,67, 69	49	900	2013-09	L6 3.0L Optional	54,57,66,67, 69	49	900
1997-96	L4 1.9L ex. Conv.	54	91	600	2003-02	L6 2.5L SULEV Optional	54,57,66,67, 69	49	850	2013-09	L6 3.0L Optional	54,57,66,67, 69	94R	640
1995	L4 1.8L	54	91	600	2001	L6 2.5L	54,57,66,67	94R	640	<b>328is</b>				
<b>318is</b>					2001	L6 2.5L	54,57,66,67	48	570	1999-96	L6 2.8L Conv.	34,54	92	575
1999-98	L4 1.9L	54	91	600	1995	L6 2.5L Conv.	34	92	1998-96	L6 2.8L ex. Conv.	54	92	650	
1997-96	L4 1.9L Conv.	34,54	92	575	1995	L6 2.5L ex. Conv.	54	92	<b>328xi</b>					
1997-96	L4 1.9L ex. Conv.	54	91	600	<b>325is</b>					2008-07	L6 3.0L	54,57,66,67	48	570
1995	L4 1.8L	54	91	600	1995	L6 2.5L Conv.	34,54	92	2008-07	L6 3.0L Optional	54,57,66,67, 69	48	760	
<b>318ti</b>					1995	L6 2.5L ex. Conv.	54	92	2008-07	L6 3.0L Optional	54,57,66,67, 69	49	720	
1999-96	L4 1.9L	54	91	600	<b>325xi</b>					2008-07	L6 3.0L Optional	54,57,66,67, 69	49	850
1995	L4 1.8L	54	91	600	2006	L6 3.0L	54,57,66,67	48	570	2008-07	L6 3.0L Optional	54,57,66,67, 69	94R	640
<b>320i</b>					2006	L6 3.0L Optional	54,57,66,67, 69	48	760	<b>330Ci</b>				
2014-12	L4 2.0L	54,57,66,67, 69	94R	800	2006	L6 3.0L Optional	54,57,66,67, 69	49	720	2006	L6 3.0L	54,67	48	570
2014-12	L4 2.0L Optional	54,57,66,67, 69	49	850	2006	L6 3.0L Optional	54,57,66,67, 69	49	720	2005-02	L6 3.0L	54,67	94R	640
2005-01	L6 2.2L	54,57,66	48	570	2006	L6 3.0L Optional	54,57,66,67, 69	49	850	2001	L6 3.0L	54	94R	765
2005-01	L6 2.2L Optional	54,57,66	94R	640	2006	L6 3.0L Optional	54,57,66,67, 69	49	900	<b>330i</b>				
1995	L6 2.0L	54	91	600	2006	L6 3.0L Optional	54,57,66,67, 69	49	900	2006	L6 3.0L	54,67	48	570
<b>320i xDrive</b>					2006	L6 3.0L Optional	54,57,66,67, 69	94R	640	2005-02	L6 3.0L	54,67	94R	640
2014-13	L4 2.0L	54,57,66,67, 69	94R	800	2005-04	L6 2.5L Eng. Code M54	54,57,66,67	94R	640	2001	L6 3.0L	54	94R	765
2014-13	L4 2.0L Optional	54,57,66,67, 69	49	850	2005-04	L6 2.5L Eng. Code M54 Optional	54,57,66,67	48	570	<b>330xi</b>				
<b>323Ci</b>					2005-04	L6 2.5L Eng. Code N52	54,57,66,67	48	570	2006	L6 3.0L	54,67	48	570
2000	L6 2.5L Conv.	54,57,66	94R	640	2005-04	L6 2.5L Eng. Code N52	54,57,66,67	48	570	2005-02	L6 3.0L	54,67	94R	640
2000	L6 2.5L ex. Conv.	54,57,66,69	48	750	2005-04	L6 2.5L Eng. Code N52 Optional	54,57,66,67, 69	48	760	2001	L6 3.0L	54	94R	765
<b>323i</b>					2005-04	L6 2.5L Eng. Code N52 Optional	54,57,66,67, 69	48	760	<b>330i</b>				
2011-06	L6 2.5L	54,57,66,67	48	570	2005-04	L6 2.5L Eng. Code N52 Optional	54,57,66,67, 69	49	720	2006	L6 3.0L	54,67	48	570
2011-06	L6 2.5L Optional	54,57,66,67, 69	48	760	2005-04	L6 2.5L Eng. Code N52 Optional	54,57,66,67, 69	49	720	2005-02	L6 3.0L	54,67	94R	640
2011-06	L6 2.5L Optional	54,57,66,67	49	720	2005-04	L6 2.5L Eng. Code N52 Optional	54,57,66,67, 69	49	850	2001	L6 3.0L	54	94R	765
2011-06	L6 2.5L Optional	54,57,66,67, 69	49	850	2005-04	L6 2.5L Eng. Code N52 Optional	54,57,66,67, 69	49	900	<b>330xi</b>				
2011-06	L6 2.5L Optional	54,57,66,67, 69	49	900	2005-04	L6 2.5L Eng. Code N52 Optional	54,57,66,67, 69	49	900	2006	L6 3.0L	54,67	48	570
2011-06	L6 2.5L Optional	54,57,66,67	94R	640	2005-04	L6 2.5L Eng. Code N52 Optional	54,57,66,67	94R	640	2005-02	L6 3.0L	54,67	94R	640
2000-99	L6 2.5L	54	94R	765	2003-01	L6 2.5L	54,57,66,67	94R	640	2001	L6 3.0L	54	94R	765
1998	L6 2.5L Conv.	34,54	92	575	2003-01	L6 2.5L Optional	54,57,66,67	48	570	<b>335d</b>				
1998	L6 2.5L ex. Conv.	54	91	600	<b>328Ci</b>					2011-09	L6 3.0L Diesel, Optional	54,57,66,67, 69	49	850
<b>323is</b>					2000	L6 2.8L	54,57,66,67	48	750	2011-09	L6 3.0L Diesel, Optional	54,57,66,67, 69	49	900
1999	L6 2.5L	54	94R	765	<b>328d</b>					2011-09	L6 3.0L Diesel, Optional	54,57,66,67, 69	94R	640
1998	L6 2.5L Conv.	34,54	92	575	2014	L4 2.0L	54,57,66,67, 69	94R	800	2014-07	L6 3.0L Optional	54,57,66,67, 69	49	850
1998	L6 2.5L ex. Conv.	54	91	600	2014	L4 2.0L Optional	54,57,66,67, 69	49	850	2014-07	L6 3.0L Optional	54,57,66,67, 69	49	900
<b>325Ci</b>					<b>328d xDrive</b>					2014	L6 3.0L	54,57,66,67, 69	94R	800
2006-03	L6 2.5L ex. SULEV	54,57,66,67	94R	640	2014	L4 2.0L	54,57,66,67, 69	94R	800	2013-07	L6 3.0L	54,57,66,67	48	570
2006-03	L6 2.5L SULEV	54,57,66,67, 69	49	900	2014	L4 2.0L	54,57,66,67, 69	94R	800	2013-07	L6 3.0L Optional	54,57,66,67, 69	48	760
2006-03	L6 2.5L SULEV Optional	54,57,66,67, 69	49	850	2014	L4 2.0L Optional	54,57,66,67, 69	49	850	2013-07	L6 3.0L Optional	54,57,66,67	49	720
2002-01	L6 2.5L	54,57,66,67	94R	640	<b>328i</b>					2013-07	L6 3.0L Optional	54,57,66,67, 69	94R	640
<b>325i</b>					2014-12	L4 2.0L	54,57,66,67, 69	94R	800	<b>335i GT xDrive</b>				
2006	L6 3.0L	54,57,66,67	48	570	2014-12	L4 2.0L Optional	54,57,66,67, 69	49	850	2014	L6 3.0L	54,57,66,67, 69	49	850
2006	L6 3.0L Optional	54,57,66,67, 69	48	760	2013-07	L6 3.0L	54,57,66,67	48	570	<b>335i xDrive</b>				
2006	L6 3.0L Optional	54,57,66,67	49	720	2013-07	L6 3.0L Optional	54,57,66,67, 69	48	760	2014-09	L6 3.0L Optional	54,57,66,67, 69	49	850
2006	L6 3.0L Optional	54,57,66,67, 69	49	850	2013-07	L6 3.0L Optional	54,57,66,67, 69	48	760	2014	L6 3.0L	54,57,66,67, 69	94R	800
2006	L6 3.0L Optional	54,57,66,67, 69	49	900	2013-07	L6 3.0L Optional	54,57,66,67	49	720					

# Passenger Car & Light Truck

YEAR	ENGINE/ OPTIONS	FOOT NOTE	GROUP/ TYPE NO.	O.E. CCA (@0°F)	YEAR	ENGINE/ OPTIONS	FOOT NOTE	GROUP/ TYPE NO.	O.E. CCA (@0°F)	YEAR	ENGINE/ OPTIONS	FOOT NOTE	GROUP/ TYPE NO.	O.E. CCA (@0°F)
<b>BMW (Cont.)</b>					<b>BMW (Cont.)</b>					<b>BMW (Cont.)</b>				
<b>335i xDrive (Cont.)</b>					<b>528i xDrive (Cont.)</b>					<b>535i xDrive (Cont.)</b>				
2013-09	L6 3.0L	54,57,66,67	48	570	2013-12	L4 2.0L Optional	54,57,66,67,69	94R	800	2010-09	L6 3.0L Optional	54,57,66,67	95R	850
2013-09	L6 3.0L Optional	54,57,66,67,69	48	760	2012	L4 2.0L Optional	54,57,66,67	95R	950	<b>535xi</b>				
2013-09	L6 3.0L Optional	54,57,66,67	49	720	2010	L6 3.0L	54,57,66,67	49	850	2008	L6 3.0L	54,57,66,67	49	720
2013-09	L6 3.0L Optional	54,57,66,67,69	49	900	2010	L6 3.0L Optional	54,57,66,67,69	49	900	2008	L6 3.0L Optional	54,57,66,67,69	49	850
2013-09	L6 3.0L Optional	54,57,66,67	94R	640	2010	L6 3.0L Optional	54,57,66,67,69	94R	800	2008	L6 3.0L Optional	54,57,66,67	94R	640
<b>335is</b>					2010	L6 3.0L Optional	54,57,66,67	95R	950	2008	L6 3.0L Optional	54,57,66,67	95R	850
2013-11	L6 3.0L	54,57,66,67	48	570	2009	L6 3.0L	54,57,66,67	49	720	<b>540i</b>				
2013-11	L6 3.0L Optional	54,57,66,67,69	48	760	2009	L6 3.0L Optional	54,57,66,67,69	49	850	2003-02	V8 4.4L	54,67	49	720
2013-11	L6 3.0L Optional	54,57,66,67	49	720	2009	L6 3.0L Optional	54,57,66,67,69	49	850	2003	V8 4.4L Optional	47,54,67	49	900
2013-11	L6 3.0L Optional	54,57,66,67,69	49	850	2009	L6 3.0L Optional	54,57,66,67	94R	640	2001-97	V8 4.4L	54	49	850
2013-11	L6 3.0L Optional	54,57,66,67,69	49	900	2009	L6 3.0L Optional	54,57,66,67	95R	850	1995	V8 4.0L	54	93	800
2013-11	L6 3.0L Optional	54,57,66,67	94R	640	<b>528xi</b>					<b>545i</b>				
<b>335xi</b>					2008	L6 3.0L	54,57,66,67	49	720	2005	V8 4.4L	54,67	94R	640
2008-07	L6 3.0L	54,57,66,67	48	570	2008	L6 3.0L Optional	54,57,66,67,69	49	850	2004	V8 4.4L	54,67	95R	850
2008-07	L6 3.0L Optional	54,57,66,67,69	48	760	2008	L6 3.0L Optional	54,57,66,67	94R	640	<b>550i</b>				
2008-07	L6 3.0L Optional	54,57,66,67	49	720	2008	L6 3.0L Optional	54,57,66,67	95R	850	2014-13	V8 4.4L Optional	54,57,66,67,69	95R	950
2008-07	L6 3.0L Optional	54,57,66,67,69	49	850	<b>530i</b>					2014-11	V8 4.4L	54,57,66,67,69	49	900
2008-07	L6 3.0L Optional	54,57,66,67,69	49	900	2007-02	L6 3.0L Optional	54,57,66,67,69	49	850	2014-11	V8 4.4L Optional	54,57,66,67,69	49	850
2008-07	L6 3.0L Optional	54,57,66,67	94R	640	2007-02	L6 3.0L Optional	54,57,66,67	94R	640	2012-11	V8 4.4L Optional	54,57,66,67	95R	950
<b>428i</b>					2007-02	L6 3.0L Optional	54,57,66,67	95R	850	2010-06	V8 4.8L	54,57,66,67	49	720
2014	L4 2.0L	54,57,66,67,69	49	850	2007-01	L6 3.0L	54,57,66,67	49	720	2010-06	V8 4.8L Optional	54,57,66,67,69	49	850
<b>428i xDrive</b>					1995	V8 3.0L	54	93	800	2010-06	V8 4.8L Optional	54,57,66,67	94R	640
2014	L4 2.0L	54,57,66,67,69	49	850	<b>530xi</b>					2010-06	V8 4.8L Optional	54,57,66,67	95R	850
<b>435i</b>					2007-06	L6 3.0L	54,57,66,67	49	720	<b>550i GT</b>				
2014	L6 3.0L	54,57,66,67,69	49	850	2007-06	L6 3.0L Optional	54,57,66,67,69	49	850	2014	V8 4.4L	54,57,66,67,69	49	850
<b>435i xDrive</b>					2007-06	L6 3.0L Optional	54,57,66,67	94R	640	2013-10	V8 4.4L	54,57,66,67,69	49	900
2014	L6 3.0L	54,57,66,67,69	49	850	2007-06	L6 3.0L Optional	54,57,66,67	95R	850	2013-10	V8 4.4L Optional	54,57,66,67,69	49	850
<b>525i</b>					<b>535d</b>					<b>550i GT xDrive</b>				
2007-06	L6 3.0L	54,66,67	95R	850	2014	L6 3.0L	54,57,66,67,69	49	850	2014	V8 4.4L	54,57,66,67,69	49	850
2007-06	L6 3.0L Optional	54,66,67	49	720	2014	L6 3.0L Optional	54,57,66,67,69	49	900	2013-10	V8 4.4L	54,57,66,67,69	49	900
2007-06	L6 3.0L Optional	54,66,67	94R	640	2014	L6 3.0L Optional	54,57,66,67,69	95R	950	2013-10	V8 4.4L Optional	54,57,66,67,69	49	900
2005-02	L6 2.5L	54,67	94R	640	<b>535d xDrive</b>					<b>550i xDrive</b>				
2005	L6 2.5L Optional	54,67	49	900	2014	L6 3.0L	54,57,66,67,69	49	850	2014-13	V8 4.4L Optional	54,57,66,67,69	95R	950
2004-02	L6 2.5L Optional	54,67	49	720	2014	L6 3.0L Optional	54,57,66,67,69	49	900	2014-11	V8 4.4L	54,57,66,67,69	49	900
2001	L6 2.5L	54	49	850	2014	L6 3.0L Optional	54,57,66,67,69	95R	950	2014-11	V8 4.4L Optional	54,57,66,67,69	49	850
1995	L6 2.5L	54	92	650	<b>535i</b>					2012-11	V8 4.4L Optional	54,57,66,67	95R	950
1995	L6 2.5L Optional	54	93	800	2014-13	L6 3.0L Optional	54,57,66,67,69	95R	950	<b>640i</b>				
<b>525xi</b>					2014-11	L6 3.0L	54,57,66,67,69	49	900	2014-13	L6 3.0L Optional	54,57,66,67,69	95R	950
2007-06	L6 3.0L	54,66,67	95R	850	2014-08	L6 3.0L Optional	54,57,66,67,69	49	850	2014-12	L6 3.0L	54,57,66,67,69	49	900
2007-06	L6 3.0L Optional	54,66,67	49	720	2013-11	L6 3.0L Optional	54,57,66,67,69	94R	800	2014-12	L6 3.0L Optional	54,57,66,67,69	49	850
2007-06	L6 3.0L Optional	54,66,67	94R	640	2012-11	L6 3.0L Optional	54,57,66,67	95R	950	2012	L6 3.0L Optional	54,57,66,67	95R	950
<b>528i</b>					2010-08	L6 3.0L	54,57,66,67	49	720	<b>640i Gran Coupe</b>				
2014-13	L4 2.0L Optional	54,57,66,67,69	95R	950	2010-08	L6 3.0L Optional	54,57,66,67	94R	640	2014-13	L6 3.0L	54,57,66,67,69	49	850
2014-12	L4 2.0L	54,57,66,67,69	49	850	2010-08	L6 3.0L Optional	54,57,66,67	95R	850	2014-13	L6 3.0L Optional	54,57,66,67,69	95R	950
2014-12	L4 2.0L Optional	54,57,66,67,69	49	900	<b>535i GT</b>					<b>640i xDrive</b>				
2013-12	L4 2.0L Optional	54,57,66,67,69	94R	800	2014	L6 3.0L	54,57,66,67,69	49	850	2014	L6 3.0L	54,57,66,67,69	49	900
2012	L4 2.0L Optional	54,57,66,67	95R	950	2013-10	L6 3.0L	54,57,66,67,69	49	900	2014	L6 3.0L Optional	54,57,66,67,69	49	850
2011-10	L6 3.0L	54,57,66,67,69	49	850	2013-10	L6 3.0L Optional	54,57,66,67,69	49	850	2014	L6 3.0L Optional	54,57,66,67,69	95R	950
2011-10	L6 3.0L Optional	54,57,66,67,69	49	900	<b>535i GT xDrive</b>					<b>640i xDrive Gran Coupe</b>				
2011-10	L6 3.0L Optional	54,57,66,67,69	94R	800	2014	L6 3.0L	54,57,66,67,69	49	850	2014	L6 3.0L	54,57,66,67,69	49	850
2011-10	L6 3.0L Optional	54,57,66,67	95R	950	2013-11	L6 3.0L	54,57,66,67,69	49	900	2014	L6 3.0L Optional	54,57,66,67,69	95R	950
2009-08	L6 3.0L	54,57,66,67	49	720	2013-11	L6 3.0L Optional	54,57,66,67,69	49	850	<b>645Ci</b>				
2009-08	L6 3.0L Optional	54,57,66,67,69	49	850	<b>535i xDrive</b>					<b>650i</b>				
2009-08	L6 3.0L Optional	54,57,66,67	94R	640	2014-13	L6 3.0L Optional	54,57,66,67,69	95R	950	2005-04	V8 4.4L	54,67	95R	850
2009-08	L6 3.0L Optional	54,57,66,67	95R	850	2014-11	L6 3.0L	54,57,66,67,69	49	900	2014-13	V8 4.4L Optional	54,57,66,67,69	95R	950
2000-97	L6 2.8L	54	49	850	2014-09	L6 3.0L Optional	54,57,66,67,69	49	850	2014	V8 4.4L	54,57,66,67,69	49	900
<b>528i xDrive</b>					2013-11	L6 3.0L Optional	54,57,66,67,69	94R	800	2014	V8 4.4L Optional	54,57,66,67,69	49	850
2014-13	L4 2.0L Optional	54,57,66,67,69	95R	950	2012-11	L6 3.0L Optional	54,57,66,67	95R	950	2014	V8 4.4L Optional	54,57,66,67,69	49	850
2014-12	L4 2.0L	54,57,66,67,69	49	850	2010-09	L6 3.0L	54,57,66,67	49	720					
2014-12	L4 2.0L Optional	54,57,66,67,69	49	900	2010-09	L6 3.0L Optional	54,57,66,67	94R	640					

# Passenger Car & Light Truck

YEAR	ENGINE/ OPTIONS	FOOT NOTE	GROUP/ TYPE NO.	O.E. CCA (@0°F)	YEAR	ENGINE/ OPTIONS	FOOT NOTE	GROUP/ TYPE NO.	O.E. CCA (@0°F)	YEAR	ENGINE/ OPTIONS	FOOT NOTE	GROUP/ TYPE NO.	O.E. CCA (@0°F)
<b>BMW (Cont.)</b>					<b>BMW (Cont.)</b>					<b>BMW (Cont.)</b>				
<b>650i (Cont.)</b>					<b>750iL</b>					<b>Alpina B7L</b>				
2013-12	V8 4.4L	54,57,66,67,69	49	850	2001	V12 5.4L	54	95R	850	2014-11	V8 4.4L	54,57,66,67,69	49	900
2012	V8 4.4L Optional	54,57,66,67,69	95R	950	2001	V12 5.4L Auxiliary	54	48	650	2014-11	V8 4.4L Optional	54,57,66,67,69	49	850
2010-06	V8 4.8L	54,57,66,67,69	49	900	2000-95	V12 5.4L	54	95R	950	<b>Alpina B7L xDrive</b>				
2010-06	V8 4.8L Optional	54,57,66,67,69	49	850	1999	V12 5.4L Auxiliary	54	48	650	2014-11	V8 4.4L	54,57,66,67,69	49	900
2007-06	V8 4.8L Optional	54,57,66,67,69	95R	850	<b>750Li</b>					2014-11	V8 4.4L Optional	54,57,66,67,69	49	850
<b>650i Gran Coupe</b>					2014-13	V8 4.4L	54,57,66,67,69	49	900	<b>M235i</b>				
2014-13	V8 4.4L	54,57,66,67,69	49	850	2014-13	V8 4.4L Optional	54,57,66,67,69	49	850	2014	L6 3.0L	54,57,66,67,69	94R	800
2014-13	V8 4.4L Optional	54,57,66,67,69	95R	950	2012	V8 4.4L Gas	54,57,66,67,69	49	900	2014	L6 3.0L Optional	54,57,66,67,69	49	850
<b>650i xDrive</b>					2012	V8 4.4L Gas, Optional	54,57,66,67,69	49	850	<b>M3</b>				
2014-13	V8 4.4L Optional	54,57,66,67,69	95R	950	2012	V8 4.4L Hybrid	54,57,66,67,69	49	900	2013-08	V8 4.0L	54,57,66,67,69	48	570
2014	V8 4.4L	54,57,66,67,69	49	900	2012	V8 4.4L Hybrid, Optional	54,57,66,67,69	49	850	2013-08	V8 4.0L Optional	54,57,66,67,69	48	760
2014	V8 4.4L Optional	54,57,66,67,69	49	850	2011-09	V8 4.4L	54,57,66,67,69	49	900	2013-08	V8 4.0L Optional	54,57,66,67,69	49	720
2013-12	V8 4.4L	54,57,66,67,69	49	850	2011-09	V8 4.4L Optional	54,57,66,67,69	49	850	2013-08	V8 4.0L Optional	54,57,66,67,69	49	850
2012	V8 4.4L Optional	54,57,66,67,69	95R	950	2008-06	V8 4.8L	54,57,66,67,69	49	900	2013-08	V8 4.0L Optional	54,57,66,67,69	49	900
<b>650i xDrive Gran Coupe</b>					2008-06	V8 4.8L Optional	54,57,66,67,69	49	850	2013-08	V8 4.0L Optional	54,57,66,67,69	94R	640
2014-13	V8 4.4L	54,57,66,67,69	49	850	<b>750Li xDrive</b>					2006	L6 3.2L	54	48	570
2014-13	V8 4.4L Optional	54,57,66,67,69	95R	950	2014-10	V8 4.4L	54,57,66,67,69	49	900	2005-02	L6 3.2L	54	94R	640
<b>740i</b>					2014-10	V8 4.4L Optional	54,57,66,67,69	49	850	2001	L6 3.2L	54	94R	765
2014-11	L6 3.0L	54,57,66,67,69	49	900	<b>760i</b>					1999-96	L6 3.2L Conv.	34,54	92	575
2014-11	L6 3.0L Optional	54,57,66,67,69	49	850	2006	V12 6.0L	54,67	49	720	1999-96	L6 3.2L ex. Conv.	54	92	650
2001	V8 4.4L	54	95R	850	2005-04	V12 6.0L	54,67	49	900	1995	L6 3.0L Conv.	34,54	92	575
2000-97	V8 4.4L	54	95R	950	<b>760Li</b>					1995	L6 3.0L ex. Conv.	54	92	650
1995	V8 4.0L	54	95R	950	2014-10	V12 6.0L	54,57,66,67,69	49	900	2014-13	V8 4.4L	54,57,66,67,69	49	900
<b>740iL</b>					2014-10	V12 6.0L Optional	54,57,66,67,69	49	850	2014-13	V8 4.4L Optional	54,57,66,67,69	49	850
2001	V8 4.4L	54	95R	850	2008-06	V12 6.0L	54,67	49	720	2014-13	V8 4.4L Optional	54,57,66,67,69	95R	950
2000-96	V8 4.4L	54	95R	950	2005-03	V12 6.0L	54,67	49	900	2010-06	V10 5.0L	54,57,66,67,69	49	720
1995	V8 4.0L	54	95R	950	<b>840Ci</b>					2010-06	V10 5.0L Optional	54,57,66,67,69	49	850
<b>740Li</b>					1997-96	V8 4.4L	54	93	800	2010-06	V10 5.0L Optional	54,57,66,67,69	94R	640
2014-11	L6 3.0L	54,57,66,67,69	49	900	1997-96	V8 4.4L Optional	54	91	600	2010-06	V10 5.0L Optional	54,57,66,67,69	95R	850
2014-11	L6 3.0L Optional	54,57,66,67,69	49	850	1995	V8 4.0L	54	93	600	2003	V8 5.0L	54	95R	800
<b>740Li xDrive</b>					1995	V8 4.0L Optional	54	91	600	2002-01	V8 5.0L	54	95R	850
2014-13	L6 3.0L	54,57,66,67,69	49	900	<b>850Ci</b>					2000	V8 5.0L	54	95R	950
2014-13	L6 3.0L Optional	54,57,66,67,69	49	850	1997-95	V12 5.4L	54	93	800	<b>M6</b>				
<b>745i</b>					1997-95	V12 5.4L Optional	54	91	600	2014-13	V8 4.4L Optional	54,57,66,67,69	95R	950
2005-04	V8 4.4L	47,54,67	49	900	<b>850CSI</b>					2014-12	V8 4.4L	54,57,66,67,69	49	900
2003-02	V8 4.4L Optional	47,54,67	49	900	1995	V12 5.6L	54	93	800	2014-12	V8 4.4L Optional	54,57,66,67,69	49	850
2003	V8 4.4L	54,67	95R	800	1995	V12 5.6L Optional	54	91	600	2012	V8 4.4L Optional	54,57,66,67,69	95R	950
2002	V8 4.4L	54,67	95R	850	<b>ActiveHybrid 3</b>					2010-06	V10 5.0L	54,57,66,67,69	49	900
<b>745Li</b>					2014-13	L6 3.0L Hybrid	54,57,66,67,69	94R	800	2010-06	V10 5.0L Optional	54,57,66,67,69	49	850
2005-04	V8 4.4L	47,54,67	49	900	2014-13	L6 3.0L Hybrid, Optional	54,57,66,67,69	49	850	<b>M6 Gran Coupe</b>				
2003-02	V8 4.4L Optional	47,54,67	49	900	<b>ActiveHybrid 5</b>					2014	V8 4.4L	54,57,66,67,69	49	850
2003	V8 4.4L	54,67	95R	800	2014-12	L6 3.0L Hybrid, Optional	54,57,66,67,69	49	850	2014	V8 4.4L Optional	54,57,66,67,69	95R	950
<b>750i</b>					2014-12	L6 3.0L Hybrid, Optional	54,57,66,67,69	95R	950	<b>X1</b>				
2014-13	V8 4.4L	54,57,66,67,69	49	900	2014	L6 3.0L Hybrid	54,57,66,67,69	49	900	2014-13	L6 3.0L	54,57,66,67,69	48	570
2014-13	V8 4.4L Optional	54,57,66,67,69	49	850	2013-12	L6 3.0L Hybrid	54,57,66,67,69	94R	800	2014-13	L6 3.0L Optional	54,57,66,67,69	48	760
2012	V8 4.4L Gas	54,57,66,67,69	49	900	2013-12	L6 3.0L Hybrid, Optional	54,57,66,67,69	49	900	2014-13	L6 3.0L Optional	54,57,66,67,69	94R	640
2012	V8 4.4L Gas, Optional	54,57,66,67,69	49	850	<b>ActiveHybrid 7</b>					2014-13	L6 3.0L Optional	54,57,66,67,69	94R	800
2012	V8 4.4L Hybrid	54,57,66,67,69	49	900	2014-13	L6 3.0L Hybrid	54,57,66,67,69	49	850	2014-12	L4 2.0L	54,57,66,67,69	48	570
2012	V8 4.4L Hybrid, Optional	54,57,66,67,69	49	850	2014-13	L6 3.0L Hybrid, Optional	54,57,66,67,69	49	900	2014-12	L4 2.0L Optional	54,57,66,67,69	48	760
2011-09	V8 4.4L	54,57,66,67,69	49	900	<b>Alpina B7</b>					2014-12	L4 2.0L Optional	54,57,66,67,69	94R	640
2011-09	V8 4.4L Optional	54,57,66,67,69	49	850	2014-11	V8 4.4L	54,57,66,67,69	49	900	2014-12	L4 2.0L Optional	54,57,66,67,69	94R	800
2008-06	V8 4.8L	54,57,66,67,69	49	900	2014-11	V8 4.4L Optional	54,57,66,67,69	49	850	<b>X3</b>				
2008-06	V8 4.8L Optional	54,57,66,67,69	49	850	2008-07	V8 4.4L	54	49	720	2014-13	L4 2.0L	54,57,66,67,69	49	900
<b>750i xDrive</b>					<b>Alpina B7 xDrive</b>					2014-13	L4 2.0L Optional	54,57,66,67,69	49	850
2014-10	V8 4.4L	54,57,66,67,69	49	900	2014-11	V8 4.4L	54,57,66,67,69	49	900	2014-13	L4 2.0L Optional	54,57,66,67,69	94R	800
2014-10	V8 4.4L Optional	54,57,66,67,69	49	850	2014-11	V8 4.4L Optional	54,57,66,67,69	49	850	2014-13	L4 2.0L Optional	54,57,66,67,69	95R	950
					2014-11	V8 4.4L Optional	54,57,66,67,69	49	850	2014-13	L6 3.0L	54,57,66,67,69	49	900

# Passenger Car & Light Truck

YEAR	ENGINE/ OPTIONS	FOOT NOTE	GROUP/ TYPE NO.	O.E. CCA (@0°F)	YEAR	ENGINE/ OPTIONS	FOOT NOTE	GROUP/ TYPE NO.	O.E. CCA (@0°F)	YEAR	ENGINE/ OPTIONS	FOOT NOTE	GROUP/ TYPE NO.	O.E. CCA (@0°F)
<b>BMW (Cont.)</b>					<b>BMW (Cont.)</b>					<b>BUICK</b>				
<b>X3 (Cont.)</b>					<b>X5 (Cont.)</b>					<b>Allure</b>				
2014-13	L6 3.0L Optional	54,57,66,67,69	49	850	2002	L6 3.0L Optional	54	49	720	2010	V6 3.0L		48	615
2014-13	L6 3.0L Optional	54,57,66,67,69	95R	950	2002	V8 4.4L	54	49	720	2010	V6 3.6L		48	615
2014	L6 3.0L Optional	54,57,66,67,69	94R	900	2002	V8 4.6L	54	49	720	2009-05	V6 3.8L		34	750
2013	L6 3.0L Optional	54,57,66,67,69	94R	800	2001-00	V8 4.4L	54	49	850	2009	V8 5.3L		85	625
2012-11	L6 3.0L 2979cc	54,57,66,67,69	49	900	2001	L6 3.0L	54	94R	765	2008-05	V6 3.6L		34	680
2012-11	L6 3.0L 2979cc, Optional	54,57,66,67,69	49	850	<b>X6</b>					2008	V8 5.3L		85	590
2012-11	L6 3.0L 2979cc, Optional	54,57,66,67,69	94R	800	2014-13	L6 3.0L Optional	54,57,66,67,69	95R	950	<b>Century</b>				
2012-11	L6 3.0L 2979cc, Optional	54,57,66,67,69	95R	950	2014-13	V8 4.4L Optional	54,57,66,67,69	95R	950	2005-97	V6 3.1L		78	600
2012-11	L6 3.0L 2996cc	54,57,66,67,69	49	900	2014-12	V8 4.4L	54,57,66,67,69	49	900	1996-95	L4 2.2L		75	525
2012-11	L6 3.0L 2996cc, Optional	54,57,66,67,69	94R	800	2014-12	V8 4.4L Optional	54,57,66,67,69	48	570	1996-95	V6 3.1L		75	525
2012-11	L6 3.0L 2996cc	54,57,66,67,69	49	900	2014-12	V8 4.4L Optional	54,57,66,67,69	49	850	<b>Commercial Chassis</b>				
2012-11	L6 3.0L 2996cc, Optional	54,57,66,67,69	94R	800	2014-11	L6 3.0L Optional	54,57,66,67,69	48	570	1996-95	V8 5.7L		78	690
2012-10	L6 3.0L 2996cc, Optional	54,57,66,67,69	49	850	2014-11	L6 3.0L Optional	54,57,66,67,69	49	850	<b>Enclave</b>				
2010	L6 3.0L 2996cc	54,57,66,67,69	48	570	2014-11	L6 3.0L Optional	54,57,66,67,69	49	850	2014-10	V6 3.6L	54	48	660
2010	L6 3.0L 2996cc, Optional	54,57,66,67,69	49	720	2014-08	L6 3.0L	54,57,66,67,69	49	900	2009-08	V6 3.6L	54	48	730
2010	L6 3.0L 2996cc, Optional	54,57,66,67,69	49	900	2012-08	L6 3.0L Optional	54,57,66,67,69	95R	950	<b>Encore</b>				
2009-04	L6 3.0L	54,57,66,67,69	48	570	2012	V8 4.4L Optional	54,57,66,67,69	95R	950	2014-13	L4 1.4L	54	47	525
2009-04	L6 3.0L Optional	54,57,66,67,69	49	720	2011-10	V8 4.4L Gas	54,57,66,67,69	49	900	<b>LaCrosse</b>				
2009-04	L6 3.0L Optional	54,57,66,67,69	49	850	2011-10	V8 4.4L Gas, Optional	54,57,66,67,69	48	570	2014-12	L4 2.4L Hybrid		47	525
2009-04	L6 3.0L Optional	54,57,66,67,69	49	900	2011-10	V8 4.4L Gas, Optional	54,57,66,67,69	49	850	2014-10	V6 3.6L		48	615
2006-04	L6 2.5L	54,67	48	570	2011-10	V8 4.4L Hybrid	54,57,66,67,69	48	760	2011-10	L4 2.4L		48	615
2005-04	L6 2.5L Optional	54,67	49	720	2011	V8 4.4L Gas, Optional	54,57,66,67,69	95R	950	2010	V6 3.0L	54	48	615
2014	L6 3.0L Diesel	54,57,66,67,69	95R	950	2010-08	L6 3.0L Optional	47,54,66,67,69	48	570	2009-08	V6 3.8L		34	720
2014	L6 3.0L Gas	54,57,66,67,69	95R	950	2009-08	L6 3.0L Optional	54,57,66,67,69	49	850	2009-08	V8 5.3L		85	590
2014	V8 4.4L	54,57,66,67,69	95R	950	2009-08	V8 4.4L	54,57,66,67,69	49	900	2008	V6 3.6L	69	34	720
2013-12	V8 4.4L Optional	54,57,66,67,69	48	570	2009-08	V8 4.4L Optional	54,57,66,67,69	48	570	2007	V6 3.6L	69	34	750
2013-11	L6 3.0L Gas, Optional	54,57,66,67,69	48	570	2009-08	V8 4.4L Optional	54,57,66,67,69	49	850	2007	V6 3.8L		34	750
2013-10	V8 4.4L	54,57,66,67,69	49	900	2009-08	V8 4.4L Optional	54,57,66,67,69	49	850	2006	V6 3.6L	69	34	690
2013-10	V8 4.4L Optional	54,57,66,67,69	49	850	2009-08	V8 4.4L	54,57,66,67,69	49	900	2006	V6 3.8L		34	690
2013-09	L6 3.0L Diesel	54,57,66,67,69	49	900	2009-08	V8 4.4L	54,57,66,67,69	48	570	2005	V6 3.6L	69	34	680
2013-09	L6 3.0L Diesel, Optional	54,57,66,67,69	48	570	2009-08	V8 4.4L	54,57,66,67,69	48	570	2005	V6 3.8L		34	680
2013-09	L6 3.0L Diesel, Optional	54,57,66,67,69	49	850	2009-08	V8 4.4L Optional	54,57,66,67,69	49	850	<b>LeSabre</b>				
2013-09	L6 3.0L Gas	54,57,66,67,69	49	900	2009-08	V8 4.4L Optional	54,57,66,67,69	49	850	2005-00	V6 3.8L	54	100	770
2013-09	L6 3.0L Gas, Optional	54,57,66,67,69	49	850	2009-08	V8 4.4L Optional	54,57,66,67,69	95R	950	1999-95	V6 3.8L		78	690
2013	L6 3.0L Diesel, Optional	54,57,66,67,69	95R	950	2009-08	V8 4.4L Optional	54,57,66,67,69	95R	950	1997	V6 3.8L Optional		78	770
2013	L6 3.0L Gas, Optional	54,57,66,67,69	95R	950	<b>Z3</b>					1995	V6 3.8L Optional		78	770
2013	V8 4.4L Optional	54,57,66,67,69	95R	950	2002	L6 2.5L	54	48	570	<b>Lucerne</b>				
2012-11	L6 3.0L Gas, Optional	54,57,66,67,69	95R	950	2002	L6 3.0L	54	48	570	2011-09	V6 3.9L	54	94R	720
2012-10	V8 4.4L Optional	54,57,66,67,69	95R	950	2002	L6 3.2L	54	48	570	2011-09	V8 4.6L	54	94R	720
2012-09	L6 3.0L Diesel, Optional	54,57,66,67,69	95R	950	2001-99	L6 2.5L	54	48	650	2008	V6 3.8L	54	48	730
2011	V8 4.4L Optional	54,57,66,67,69	48	750	2001-98	L6 3.2L	54	48	650	2008	V8 4.6L	54	48	730
2010-07	V8 4.8L	54,57,66,67,69	49	850	2001	L6 3.0L	54	48	650	2007-06	V6 3.8L	54	79	800
2010-07	V8 4.8L	54,57,66,67,69	49	900	2000-97	L6 2.8L	54	48	650	2007-06	V8 4.6L	54	79	800
2010	V8 4.4L Optional	47,54,66,67,69	48	570	1998-96	L4 1.9L	54	48	650	<b>Park Avenue</b>				
2008-07	L6 3.0L	54,57,66,67,69	49	900	<b>Z4</b>					2005-03	V6 3.8L ex. Supercharged		34	690
2006-04	V8 4.4L	54	49	720	2014-12	L4 2.0L	54,57,66,67,69	48	760	2005-03	V6 3.8L Supercharged		34	770
2006-04	V8 4.8L	54,57,66,67,69	49	720	2014-12	L4 2.0L Optional	54,57,66,67,69	94R	800	2002-98	V6 3.8L ex. Supercharged		78	690
2006-04	V8 4.8L Optional	54,57,66,67,69	94R	640	2014-09	L6 3.0L	54,57,66,67,69	48	760	2002-98	V6 3.8L Supercharged		78	770
2006	L6 3.0L	54	49	720	2014-09	L6 3.0L Optional	54,57,66,67,69	94R	800	1997-96	V6 3.8L		78	690
2005-02	L6 3.0L	54	94R	640	2010	L6 3.0L Turbo	54,57,66,67,69	48	760	1997-95	V6 3.8L Optional		78	770
2005	V8 4.4L Optional	47,54,67	49	900	2010	L6 3.0L Turbo, Optional	54,57,66,67,69	94R	800	1995	V6 3.8L		78	600
2003	V8 4.4L	54	49	740	2008-06	L6 3.0L	54,57,66,67,69	47	480	<b>Rainier</b>				
2003	V8 4.6L	54	49	740	2008-06	L6 3.0L Optional	54,57,66,67,69	48	570	2007-04	L6 4.2L	40	78	600
					2008-06	L6 3.0L Optional	54,57,66,67,69	48	760	2007-04	V8 5.3L	40	78	600
					2008-06	L6 3.0L Optional	54,57,66,67,69	94R	640	<b>Regal</b>				
					2008-06	L6 3.2L	54	47	480	2014-12	L4 2.4L Hybrid		47	525
					2005-04	L6 2.5L	54	47	480	2014-11	L4 2.0L		48	615
					2005-04	L6 2.5L Optional	54	48	570	2012-11	L4 2.4L		48	615
					2005-04	L6 2.5L Optional, Telematics	54	94R	640	2004-97	V6 3.8L Supercharged		78	770
					2005-04	L6 3.0L	54	47	480	2004	V6 3.8L ex. Supercharged		78	600
					2005-04	L6 3.0L Optional	54	48	570	2003-97	V6 3.8L ex. Supercharged		78	690
					2005-03	L6 3.0L Optional, Telematics	54	94R	640	1996	V6 3.1L		78	600
					2003	L6 2.5L	54	48	570	1996	V6 3.8L		78	690
					2003	L6 3.0L	54	48	570	1995	V6 3.1L		75	525
					<b>Z8</b>					1995	V6 3.8L		75	600
					2003	V8 4.8L	54	49	740	<b>Rendezvous</b>				
					2003	V8 5.0L	54	49	740	2007-06	V6 3.5L		78	600
					2002	V8 5.0L	54	49	720	2006	V6 3.6L		34	690
					2001-00	V8 5.0L	54	49	850	2005-04	V6 3.6L		78	600

# Passenger Car & Light Truck

YEAR	ENGINE/ OPTIONS	FOOT NOTE	GROUP/ TYPE NO.	O.E. CCA (@0°F)	YEAR	ENGINE/ OPTIONS	FOOT NOTE	GROUP/ TYPE NO.	O.E. CCA (@0°F)	YEAR	ENGINE/ OPTIONS	FOOT NOTE	GROUP/ TYPE NO.	O.E. CCA (@0°F)
<b>BUICK (Cont.)</b>					<b>CADILLAC (Cont.)</b>					<b>CHEVROLET (Cont.)</b>				
<b>Rendezvous (Cont.)</b>					<b>Escalade EXT</b>					<b>C2500</b>				
2005-02	V6 3.4L		78	600	2013-12	V8 6.2L		48	660	2000-99	V8 5.7L Optional		78	690
<b>Riviera</b>					2013-09	V8 6.2L Optional		48	730	2000-99	V8 6.5L Diesel & Optional	2	78	690
1999-98	V6 3.8L	54	79	840	2011-07	V8 6.2L		48	615	2000-99	V8 7.4L Optional		78	690
1997-95	V6 3.8L	54	76	970	2006-02	V8 6.0L		78	600	2000-97	V8 6.5L Diesel	2	78	600
<b>Roadmaster</b>					<b>Fleetwood</b>					2000 V8 5.7L				
1996-95	V8 5.7L		78	600	1996-95	V8 5.7L RWD		78	770	2000	V8 7.4L		78	600
<b>Skylark</b>					<b>Seville</b>					1999 V8 5.7L Police & Optional				
1998-96	L4 2.4L		75	600	2004-98	V8 4.6L	54	79	800	1999	V8 5.7L Primary Battery		78	600
1998-95	V6 3.1L		75	600	1997-95	V8 4.6L		78	770	1999	V8 7.4L Police & Optional		78	770
1995	L4 2.3L		75	600	<b>SRX</b>					1999 V8 7.4L Primary Battery				
<b>Terraza</b>					2014-12 V6 3.6L					1999 V8 7.4L Police & Optional				
2007-06	V6 3.9L		34	600	2011-10	V6 2.8L		48	615	1999	V8 7.4L Primary Battery		78	600
2006-05	V6 3.5L		34	600	2011-10	V6 3.0L		48	615	1998-95	V8 5.0L		78	600
<b>Verano</b>					2009-08 V6 3.6L					1998-95 V8 5.7L				
2014-13	L4 2.0L		48	615	2009-08	V8 4.6L		48	730	1998-95	V8 7.4L		78	600
2014-12	L4 2.4L		48	615	2007-04	V6 3.6L		101	540	1997	V8 5.0L Optional		78	690
<b>CADILLAC</b>					<b>STS</b>					1996-95 V8 6.5L Diesel				
<b>ATS</b>					2011-10 V6 3.6L					1995 V6 4.3L				
2014-13	L4 2.0L	54,69	48	700	2010	V8 4.6L		48	660	<b>C2500 Suburban</b>				
2014-13	L4 2.0L Start Stop	54,69	94R	730	2009-08	V6 3.6L		48	730	1999-97	V8 6.5L Diesel	2	78	600
2014-13	L4 2.5L	54,69	48	700	2009-08	V8 4.4L		48	730	1999	V8 5.7L Optional		78	690
2014-13	L4 2.5L Start Stop	54,69	94R	730	2009-08	V8 4.6L		48	730	1999	V8 5.7L Police & Optional		78	770
2014-13	V6 3.6L	54,69	48	700	2007-06	V8 4.4L		101	540	1999	V8 5.7L Primary Battery		78	600
2014-13	V6 3.6L Start Stop	54,69	94R	730	2007-05	V6 3.6L		101	540	1999	V8 6.5L Diesel & Optional	2	78	690
<b>Catera</b>					<b>XLR</b>					1999 V8 7.4L Optional				
2001-97	V6 3.0L	9	91	600	2009-08	V8 4.4L		85	590	1999	V8 7.4L Police & Optional		78	770
<b>Commercial Chassis</b>					2009-08 V8 4.6L					1999 V8 7.4L Primary Battery				
1996-95	V8 5.7L		78	770	2007-06	V8 4.4L	54	90	590	1999	V8 7.4L Police & Optional		78	770
<b>CTS</b>					2007-06 V8 4.6L					1999 V8 7.4L Primary Battery				
2014-10	V6 3.0L	54	48	660	2005-04	V8 4.6L	54	86	590	1998-95	V8 5.7L		78	600
2014-10	V6 3.6L	54	48	660	<b>XTS</b>					1998-95 V8 7.4L				
2014-10	V8 6.2L	54	48	660	2014-13	V6 3.6L		48	660	1996-95	V8 6.5L Diesel	2	78	770
2014	L4 2.0L	54	48	660	<b>CHEVROLET</b>					<b>C3500</b>				
2014	L4 2.0L Start Stop	54,69	94R	730	<b>Astro</b>					2000-99 V8 5.7L Optional				
2014	V6 3.0L Start Stop	54,69	94R	730	2005-95	V6 4.3L		78	600	2000-99	V8 6.5L Diesel & Optional	2	78	690
2014	V6 3.6L Start Stop	54,69	94R	730	2005-02	V6 4.3L Optional		78	770	2000-99	V8 7.4L Optional		78	690
2014	V8 6.2L Start Stop	54,69	94R	730	<b>Avalanche</b>					2000-97 V8 6.5L Diesel				
2009-08	V6 3.6L	54	48	730	2013-09	V8 5.3L Optional		48	730	2000	V8 5.7L		78	600
2009	V8 6.2L	54	48	730	2013-07	V8 5.3L		48	615	2000	V8 7.4L		78	600
2007-06	V8 6.0L		101	540	2009-07	V8 6.0L		48	615	1999	V8 5.7L Police & Optional		78	770
2007-05	V6 2.8L		101	540	2009	V8 6.0L Optional		48	730	1999	V8 5.7L Primary Battery		78	600
2007-04	V6 3.6L		101	540	<b>Avalanche 1500</b>					1999 V8 5.7L Police & Optional				
2005-04	V8 5.7L		101	540	2006-02	V8 5.3L		78	600	1999	V8 7.4L Primary Battery		78	600
2004-03	V6 3.2L		101	540	<b>Avalanche 2500</b>					1999 V8 7.4L Police & Optional				
<b>DeVille</b>					2006-02 V8 8.1L					1999 V8 7.4L Primary Battery				
2005-00	V8 4.6L	54	79	800	<b>Aveo</b>					1998-95 V8 5.7L				
1999-95	V8 4.6L		78	770	2011-04	L4 1.6L		86	550	1998-95	V8 7.4L		78	600
1995	V8 4.9L		78	770	<b>Aveo5</b>					1996-95 V8 6.5L Diesel				
<b>DTS</b>					2011-06 L4 1.6L					2				
2011-09	V8 4.6L	54	94R	720	<b>Beretta</b>					1999 V8 5.7L				
2008	V8 4.6L	54	48	730	1996-95	L4 2.2L		75	525	2014-10	V6 3.6L	54	94R	720
2007-06	V8 4.6L	54	79	800	1996-95	L4 2.2L Optional		75	600	2014-10	V8 6.2L	54	94R	720
<b>Eldorado</b>					1996-95 V6 3.1L					2014 V8 7.0L				
2002-95	V8 4.6L		78	770	<b>Blazer</b>					2002-95 V6 3.8L				
<b>ELR</b>					2005-95 V6 4.3L					2002-95 V8 5.7L				
2014	L4 1.4L Hybrid	45,52,54,69	LN1	520	2005-95	V6 4.3L		75	525	1995	V6 3.4L		75	525
<b>Escalade</b>					2005-95 V6 4.3L Optional					1999 V8 5.7L				
2014-12	V8 6.2L		48	660	<b>C1500</b>					1999 V8 5.0L				
2014-09	V8 6.2L Optional		48	730	1999-95	V8 5.0L		78	600	1999-95	V8 5.7L		78	600
2013-12	V8 6.0L Hybrid		48	660	1999	V8 5.0L Optional		78	690	1999	V8 5.7L Optional		78	690
2013-09	V8 6.0L Hybrid, Optional		48	730	1999	V8 5.7L Optional		78	690	1998-97	V8 6.5L Diesel	2	78	600
2011-09	V8 6.0L Hybrid		48	615	1998-97	V8 6.5L Diesel		78	600	1998-95	V6 4.3L		78	600
2011-07	V8 6.2L		48	615	1996-95	V8 6.5L Diesel		78	770	1996-95	V8 6.5L Diesel	2	78	770
2006-02	V8 6.0L		78	600	<b>C1500 Suburban</b>					2014 V6 3.6L Police Package: Optional Auxiliary Battery				
2005-02	V8 5.3L		78	600	1999-97	V8 6.5L Diesel	2	78	600	2014	V6 3.6L Police Package: Primary Battery	45,52,54,69	LN3	700
2000-99	V8 5.7L		78	600	1999-95	V8 5.7L		78	600	2014	V6 3.6L Police Package: Primary Battery	45,52,54,69	LN3	700
2000-99	V8 5.7L Optional		78	690	1999	V8 5.7L Optional		78	690	2014	V8 6.0L Police Package: Optional Auxiliary Battery	45,52,54,69	LN3	700
<b>Escalade ESV</b>					1999-95 V8 5.7L					2014 V8 6.0L Police Package: Primary Battery				
2014-12	V8 6.2L		48	660	1999	V8 5.7L		78	600	2013-12	V6 3.6L Police Package	54	94R	765
2014-09	V8 6.2L Optional		48	730	1999	V8 5.7L Optional		78	690	2013-11	V8 6.0L Police Package	54	94R	765
2011-07	V8 6.2L		48	615	1999	V8 6.5L Diesel & Optional	2	78	690					
2006-03	V8 6.0L		78	600	1996-95	V8 6.5L Diesel	2	78	770					

# Passenger Car & Light Truck

YEAR	ENGINE/ OPTIONS	FOOT NOTE	GROUP/ TYPE NO.	O.E. CCA (@0°F)	YEAR	ENGINE/ OPTIONS	FOOT NOTE	GROUP/ TYPE NO.	O.E. CCA (@0°F)	YEAR	ENGINE/ OPTIONS	FOOT NOTE	GROUP/ TYPE NO.	O.E. CCA (@0°F)
<b>CHEVROLET (Cont.)</b>					<b>CHEVROLET (Cont.)</b>					<b>CHEVROLET (Cont.)</b>				
<b>Caprice (Cont.)</b>					<b>Express 1500 (Cont.)</b>					<b>Impala (Cont.)</b>				
1996-95	V8 4.3L		78	600	2005-03	V6 4.3L Optional		79	800	2014	L4 2.5L		48	615
1996-95	V8 5.7L Primary Battery		78	600	2005-03	V8 5.3L Optional		79	800	2011-10	V6 3.9L ex. Police		34	600
1996-95	V8 5.7L SEO or Optional		78	770	2002-96	V8 5.0L		78	600	2011-10	V6 3.9L Police		34	720
<b>Captiva Sport</b>					2002-96	V8 5.7L		78	600	2011-08	V6 3.5L		34	600
2014-12	L4 2.4L		48	615	2002	V6 4.3L Optional		78	770	2009-08	V8 5.3L		85	590
2012	V6 3.0L		48	660	2002	V8 5.0L Optional		78	770	2009	V6 3.9L		34	600
<b>Cavalier</b>					2002	V8 5.7L Optional		78	770	2008	V6 3.9L		34	720
2005-95	L4 2.2L		75	525	2001-00	V6 4.3L Optional		78	690	2007-06	V6 3.5L		34	690
2002-96	L4 2.4L		75	600	2001-00	V8 5.0L Optional		78	690	2007-06	V6 3.9L		34	750
2002	L4 2.2L		75	600	2001-00	V8 5.7L Optional		78	690	2007-06	V8 5.3L		85	625
1995	L4 2.3L		75	600	<b>Express 2500</b>					2005-03	V6 3.8L		78	600
<b>Classic</b>					2014-07	V8 6.6L Diesel	2	78	770	2005-00	V6 3.4L		78	600
2005-04	L4 2.2L		75	525	2014-03	V8 4.8L		78	600	2002-00	V6 3.8L Optional		78	690
<b>Cobalt</b>					2014-03	V8 6.0L		78	600	2000	V6 3.4L Optional		78	690
2010-09	L4 2.0L	54	90	590	2006	V8 6.6L Diesel	2	79	800	2000	V6 3.8L		78	600
2010-08	L4 2.2L	54	90	590	2005-96	V6 4.3L		78	600	1996-95	V8 5.7L Primary Battery		78	600
2008-05	L4 2.0L	54	90	600	2005-03	V6 4.3L Optional		79	800	1996-95	V8 5.7L SEO or Optional		78	770
2008	L4 2.4L	54	90	590	2005-03	V8 4.8L Optional		79	800	<b>Impala Limited</b>				
2007-06	L4 2.4L	54	90	600	2005-03	V8 5.3L		78	600	2014	V6 3.6L ex. Police		34	600
2007-05	L4 2.2L	54	90	600	2005-03	V8 5.3L Optional		79	800	2014	V6 3.6L Police		34	720
<b>Colorado</b>					2002-96	V8 5.7L		78	600	<b>K1500</b>				
2012-10	V8 5.3L	40	86	590	2002	V6 4.3L Optional		78	770	1999	V8 5.0L Optional		78	690
2012-08	L4 2.9L	40	86	590	2002	V8 5.0L Optional		78	770	1999	V8 5.0L Police & Optional		78	770
2012-08	L5 3.7L	40	86	590	2002	V8 5.7L Optional		78	770	1999	V8 5.0L Primary Battery		78	600
2009	V8 5.3L	11,40	86	590	2002	V8 6.5L Diesel	2	78	770	1999	V8 5.7L Optional		78	690
2007	L4 2.9L	11,40	86	640	2001-00	V6 4.3L Optional		78	690	1999	V8 5.7L Police & Optional		78	770
2007	L5 3.7L	11,40	86	590	2001-00	V8 5.0L Optional		78	690	1999	V8 5.7L Primary Battery		78	600
2006-04	L4 2.8L	11,40	86	640	2001-00	V8 5.7L Optional		78	690	1998-97	V8 5.7L Primary Battery		78	600
2006-04	L5 3.5L	11,40	86	590	2001-00	V8 6.5L Diesel & Optional	2	78	690	1998-97	V8 6.5L Diesel	2	78	600
<b>Corsica</b>					2001	V8 6.5L Diesel	2	78	600	1998-95	V6 4.3L		78	600
1996-95	L4 2.2L		75	525	1999-96	V8 6.5L Diesel	2	78	600	1998-95	V8 5.0L		78	600
1996-95	L4 2.2L Optional		75	600	<b>Express 3500</b>					1998-95	V8 5.7L		78	600
1996-95	V6 3.1L		75	600	2014-07	V8 6.6L Diesel	2	78	770	1998-95	V8 5.7L Diesel	2	78	770
<b>Corvette</b>					2014-05	V8 4.8L		78	600	<b>K1500 Suburban</b>				
2014	V8 6.2L	54	48	615	2014-03	V8 6.0L		78	600	1999-97	V8 6.5L Diesel	2	78	600
2013-09	V8 7.0L	54	90	590	2006	V8 6.6L Diesel	2	79	800	1999	V8 5.7L Optional		78	690
2013	V8 6.2L VIN W ex. Z52		85	590	2005-03	V8 6.0L Optional		79	800	1999	V8 5.7L Police & Optional		78	770
2013	V8 6.2L VIN W Z52 & VIN T	54	90	590	2002-96	V8 5.7L		78	600	1999	V8 5.7L Primary Battery		78	600
2012-11	V8 6.2L ex. ZR1		85	590	2002-01	V8 8.1L		78	600	1999	V8 5.7L Primary Battery		78	600
2012-11	V8 6.2L ZR1	54	90	590	2002	V8 5.7L Optional		78	770	1999	V8 6.5L Diesel & Optional	2	78	690
2010	V8 6.2L ex. Z52		85	590	2002	V8 8.1L Optional	2	78	770	1998-95	V8 5.7L		78	600
2010	V8 6.2L Z52	54	90	590	2001-96	V8 6.5L Diesel	2	78	600	1996-95	V8 6.5L Diesel	2	78	770
2009-08	V8 6.2L		85	590	2001-00	V8 5.7L Optional		78	690	<b>K2500</b>				
2008-07	V8 7.0L	54	90	600	2001-00	V8 6.5L Diesel & Optional	2	78	690	2000-99	V8 5.7L Optional		78	690
2007	V8 6.0L	54	90	600	2001	V8 8.1L Optional		78	690	2000-99	V8 6.5L Diesel & Optional	2	78	690
2006	V8 6.0L		90	590	2000-96	V8 7.4L		78	600	2000-99	V8 7.4L Optional		78	690
2006	V8 7.0L	54	90	590	2000	V8 7.4L Optional		78	690	2000-97	V8 6.5L Diesel	2	78	600
2005	V8 6.0L		86	590	<b>Express 4500</b>					2000	V8 5.7L		78	600
2004	V8 5.7L		86	590	2014-09	V8 6.0L		78	600	2000	V8 7.4L		78	600
2003	V8 5.7L	47	75	600	2014-09	V8 6.6L Diesel	2	78	770	1999	V8 7.4L Police & Optional		78	770
2002	V8 5.7L	47	75	525	<b>G10</b>					1999	V8 7.4L Primary Battery		78	600
2001	V8 5.7L	47	75	500	1995	V6 4.3L		78	600	1998-97	V8 5.0L		78	600
2000-97	V8 5.7L		78	600	1995	V8 5.0L		78	600	1998-95	V8 5.7L		78	600
1996-95	V8 5.7L 16 Valve		75	525	<b>G20</b>					1998-95	V8 7.4L		78	600
1996-95	V8 5.7L 32 Valve		75	690	1995	V6 4.3L		78	600	1996-95	V8 6.5L Diesel	2	78	770
<b>Cruze</b>					1995	V8 5.0L		78	600	1995	V6 4.3L		78	600
2014-11	L4 1.4L		47	525	1995	V8 5.7L		78	600	1995	V8 5.0L		78	600
2014-11	L4 1.8L		47	525	1995	V8 6.5L Diesel	2	78	600	<b>K2500 Suburban</b>				
2014	L4 2.0L Diesel	69	94R	730	<b>G30</b>					1999-97	V8 6.5L Diesel	2	78	600
<b>Epica</b>					1996-95	V8 5.7L		78	600	1999	V8 5.7L Optional		78	690
2006-04	L6 2.5L		34	600	1996-95	V8 6.5L Diesel	2	78	600	1999	V8 5.7L Police & Optional		78	770
<b>Equinox</b>					1996-95	V8 7.4L		78	600	1999	V8 5.7L Primary Battery		78	600
2014-13	V6 3.6L		48	660	1995	V6 4.3L		78	600	1999	V8 6.5L Diesel & Optional	2	78	690
2014-10	L4 2.4L		47	525	<b>HHR</b>					1999	V8 7.4L Police & Optional		78	770
2012	V6 3.0L		48	660	2011-06	L4 2.2L	54	90	600	1999	V8 5.7L Primary Battery		78	600
2011-10	V6 3.0L		48	615	2011-06	L4 2.4L	54	90	600	1999	V8 6.5L Diesel & Optional	2	78	690
2009-08	V6 3.6L		47	650	2010-08	L4 2.0L	54	90	600	1999	V8 7.4L Police & Optional		78	770
2009-07	V6 3.4L		47	650	<b>Impala</b>					1999	V8 5.7L Optional		78	690
2006-05	V6 3.4L		75	600	2014-12	V6 3.6L ex. Police		34	600	1999	V8 7.4L Police & Optional		78	770
<b>Express 1500</b>					2014-12	V6 3.6L Police		34	720	1999	V8 7.4L Police & Optional		78	770
2014-96	V6 4.3L		78	600	2014	L4 2.4L Hybrid		48	615					
2014-03	V8 5.3L		78	600										

# Passenger Car & Light Truck

YEAR	ENGINE/ OPTIONS	FOOT NOTE	GROUP/ TYPE NO.	O.E. CCA (@0°F)	YEAR	ENGINE/ OPTIONS	FOOT NOTE	GROUP/ TYPE NO.	O.E. CCA (@0°F)	YEAR	ENGINE/ OPTIONS	FOOT NOTE	GROUP/ TYPE NO.	O.E. CCA (@0°F)
<b>CHEVROLET (Cont.)</b>					<b>CHEVROLET (Cont.)</b>					<b>CHEVROLET (Cont.)</b>				
<b>K2500 Suburban (Cont.)</b>					<b>Oprtra</b>					<b>Silverado 2500 HD (Cont.)</b>				
1999	V8 7.4L Primary Battery		78	600	2007-04	L4 2.0L		86	640	2005-01	V8 6.0L Optional		78	770
1998-95	V8 5.7L		78	600	Orlando	L4 2.0L				2005-01	V8 8.1L Optional		78	770
1998-95	V8 7.4L		78	600	2014-12	L4 2.4L		48	615	2002-01	V8 6.6L Diesel	2	78	600
1996-95	V8 6.5L Diesel	2	78	770	<b>P30</b>					2002-01	V8 6.6L Diesel, Optional	2	78	770
<b>K3500</b>					1999-95	V6 4.3L		78	600	<b>Silverado 3500</b>				
2000-99	V8 5.7L Optional		78	690	1999-95	V8 5.7L		78	600	2007-03	V8 6.6L Diesel	2	78	770
2000-99	V8 6.5L Diesel & Optional	2	78	690	1999-95	V8 6.5L Diesel	2	78	600	2007	V8 6.0L Early		48	615
2000-99	V8 7.4L Optional		78	690	1999-95	V8 7.4L		78	600	2007	V8 8.1L Late		78	600
2000-97	V8 6.5L Diesel	2	78	600	<b>Prizm</b>					2007	V8 8.1L Early		48	615
2000	V8 5.7L		78	600	2002-98	L4 1.8L		35	310	2007	V8 8.1L Late		78	600
2000	V8 7.4L		78	600	<b>S10</b>					2006-01	V8 6.0L		78	600
1999	V8 5.7L Police & Optional		78	770	2004-03	V6 4.3L		75	525	2006-01	V8 8.1L		78	600
1999	V8 5.7L Primary Battery		78	600	2004-03	V6 4.3L Optional		75	690	2005-01	V8 6.0L Optional		78	770
1999	V8 7.4L Police & Optional		78	770	2003-95	L4 2.2L		75	525	2005-01	V8 8.1L Optional		78	770
1999	V8 7.4L Primary Battery		78	600	2003	L4 2.2L Optional		75	690	2002-01	V8 6.6L Diesel	2	78	600
1999	V8 7.4L Primary Battery		78	600	2002	V6 4.3L		75	690	2002-01	V8 6.6L Diesel, Optional	2	78	770
1998-95	V8 5.7L		78	600	2001-95	V6 4.3L		75	525	<b>Silverado 3500 HD</b>				
1998-95	V8 7.4L		78	600	2001-95	V6 4.3L Optional		75	690	2014-08	V8 6.6L Diesel	2	48	730
1996-95	V8 6.5L Diesel	2	78	770	2000-95	L4 2.2L Optional		75	690	2014	V8 6.0L		94R	720
<b>LLV</b>					<b>Silverado 1500</b>					2013-09	V8 6.0L Optional		48	730
1995	L4 2.2L		75	525	2014	V6 4.3L		94R	720	2013-09	V8 6.0L Optional		48	730
1995	L4 2.2L Optional		78	690	2014	V8 5.3L		94R	720	2013-08	V8 6.0L		48	615
<b>Lumina</b>					2014	V8 6.2L		94R	720	2007	V8 6.0L Early		78	600
2001-96	V6 3.1L		78	600	2013-09	V6 4.3L Optional		48	730	2007	V8 6.0L Late		48	615
1999-98	V6 3.8L		78	690	2013-09	V8 4.8L Optional		48	730	2007	V8 6.6L Diesel	2	78	770
1997-96	V6 3.4L		78	690	2013-09	V8 5.3L Optional		48	730	<b>Sonic</b>				
1995	V6 3.1L Primary Battery		75	525	2013-09	V8 6.2L		48	615	2014-12	L4 1.4L		47	525
1995	V6 3.1L SEO or Optional		75	690	2013-09	V8 6.2L Optional		48	730	2014-12	L4 1.8L		47	525
1995	V6 3.4L		75	690	2013-08	V6 4.3L		48	615	<b>Spark</b>				
<b>Lumina APV</b>					2013-08	V8 4.8L		48	615	2014-13	L4 1.2L	45,52	LN1	410
1996	V6 3.4L		75	525	2013-08	V8 5.3L		48	615	<b>Spark EV</b>				
1995	V6 3.1L		75	525	2013	V8 6.0L Hybrid		48	730	2014	Electric	45,52,69	LN1	520
1995	V6 3.8L		75	630	2012-10	V8 6.0L Hybrid		48	615	<b>SSR</b>				
<b>Malibu</b>					2012-10	V8 6.0L Hybrid, Optional		48	730	2006-05	V8 6.0L		78	600
2014-13	L4 2.0L		47	525	2009-08	V8 6.0L		48	615	2004-03	V8 5.3L		78	600
2014-13	L4 2.4L Hybrid		47	525	2009	V8 6.0L Optional		48	730	<b>Suburban 1500</b>				
2014	L4 2.5L Auxiliary	54	N/A		2007-07	V8 5.3L Early		78	600	2014-12	V8 5.3L		48	660
2014	L4 2.5L Start Stop	69		850	2007-07	V8 5.3L Late		48	615	2014-09	V8 5.3L Optional		48	730
2013	L4 2.5L		49	525	2007	V6 4.3L Early		78	600	2011-07	V8 5.3L		48	615
2012-09	L4 2.4L		90	590	2007	V6 4.3L Late		48	615	2009-07	V8 6.0L		48	615
2012-08	V6 3.6L		90	590	2007	V6 4.3L Late		48	615	2009	V8 6.0L Optional		48	730
2010-08	V6 3.5L		90	590	2007	V8 4.8L Early		78	600	2006-02	V8 5.3L		78	600
2008	L4 2.2L		90	590	2007	V8 4.8L Late		48	615	2006	V8 6.0L		78	600
2008	L4 2.4L Hybrid		90	590	2007	V8 6.0L Early		78	600	2006	V8 6.0L Optional		78	690
2007-04	L4 2.2L		75	525	2007	V8 6.0L Late		48	615	2005-03	V8 5.3L Optional		78	770
2007	V6 3.5L		75	690	2006-99	V6 4.3L		78	600	2002-00	V8 5.3L Optional		78	690
2007	V6 3.9L		75	690	2006-99	V8 4.8L		78	600	2001-00	V8 5.3L Primary Battery		78	600
2006-04	V6 3.5L		75	525	2007	V8 6.0L Late		48	615	2000	V8 5.3L Police & Optional		78	770
2006	V6 3.9L		75	590	2006-99	V6 4.3L		78	600	<b>Suburban 2500</b>				
2003-97	V6 3.1L		75	600	2006-99	V8 4.8L		78	600	2013-12	V8 6.0L		48	660
1999-97	L4 2.4L		75	600	2006-99	V8 5.3L		78	600	2013-09	V8 6.0L Optional		48	730
<b>Metro</b>					2006-03	V8 6.0L		78	600	2011-07	V8 6.0L		48	615
2001-98	L4 1.3L		26R	390	2005-99	V6 4.3L Optional		78	770	2006-02	V8 6.0L		78	600
2000-98	L3 1.0L		26R	390	2005-99	V8 4.8L Optional		78	770	2006-02	V8 8.1L		78	600
<b>Monte Carlo</b>					2005-03	V8 6.0L Optional		78	770	2005-03	V8 6.0L Optional		78	770
2007-06	V8 5.3L		85	625	2005-99	V8 5.3L Optional		78	770	2005-03	V8 8.1L Optional		78	770
2007	V6 3.5L		34	690	2005-03	V8 6.0L		78	600	2002-01	V8 8.1L Optional		78	690
2006	V6 3.5L		34	600	2004-99	V8 6.0L		78	600	2002-00	V8 6.0L Optional		78	690
2006	V6 3.9L		34	750	2004-99	V8 6.0L Optional		78	770	2001-00	V8 6.0L Primary Battery		78	600
2005-04	V6 3.8L		78	770	2000-99	V8 5.3L Optional		78	770	2001	V8 8.1L Primary Battery		78	600
2005-00	V6 3.4L		78	600	<b>Silverado 2500 HD</b>					2000	V8 6.0L Police & Optional		78	770
2003-98	V6 3.8L		78	600	2014-08	V8 6.6L Diesel	2	48	730	<b>Tahoe</b>				
2000	V6 3.4L Optional		78	690	2014	V8 6.0L		94R	720	2014-12	V8 5.3L		48	660
2000	V6 3.8L Optional		78	690	2013-09	V8 6.0L Optional		48	730	2014-09	V8 5.3L Optional		48	730
1999-96	V6 3.1L		78	600	2013-08	V8 6.0L		48	615	2013-12	V8 6.0L Hybrid		48	660
1997-96	V6 3.4L		78	600	2007-03	V8 6.6L Diesel	2	78	770	2013-09	V8 6.0L Hybrid, Optional		48	730
1995	V6 3.1L Primary Battery		75	525	2007	V8 6.0L Early		78	600	2011-08	V8 6.0L Hybrid		48	615
1995	V6 3.1L SEO or Optional		75	690	2007	V8 6.0L Late		48	615	2011-07	V8 5.3L		48	615
1995	V6 3.4L		75	690	2007	V8 8.1L Early		78	600	2009-08	V8 6.2L		48	615
					2007	V8 8.1L Late		48	615	2009-08	V8 6.2L Optional		48	730
					2006-01	V8 6.0L		78	600					
					2006-01	V8 8.1L		78	600					

# Passenger Car & Light Truck

YEAR	ENGINE/ OPTIONS	FOOT NOTE	GROUP/ TYPE NO.	O.E. CCA (@0°F)	YEAR	ENGINE/ OPTIONS	FOOT NOTE	GROUP/ TYPE NO.	O.E. CCA (@0°F)	YEAR	ENGINE/ OPTIONS	FOOT NOTE	GROUP/ TYPE NO.	O.E. CCA (@0°F)	
<b>CHEVROLET (Cont.)</b>					<b>CHRYSLER (Cont.)</b>					<b>CHRYSLER (Cont.)</b>					
<b>Tahoe (Cont.)</b>					<b>Cirrus (Cont.)</b>					<b>Sebring (Cont.)</b>					
2009-07	V8 4.8L		48	615	1997-95	L4 2.4L		75	510	1997-95	L4 2.0L ex. Conv., AT		86	525	
2009	V8 4.8L Optional		48	730	<b>Concorde</b>					1995	L4 2.0L ex. Conv., MT		86	525	
2006-00	V8 4.8L		78	600	2004-98	V6 2.7L		34	500	<b>Town &amp; Country</b>					
2006-00	V8 5.3L		78	600	2004-02	V6 3.5L		34	600	2014-12	V6 3.6L		94R	730	
2005-03	V8 4.8L Optional		78	770	2001-98	V6 3.2L		34	600	2011	V6 3.6L		94R	700	
2005-03	V8 5.3L Optional		78	770	1997-95	V6 3.5L		34	600	2010	V6 3.3L		34	600	
2002-00	V8 4.8L Optional		78	690	1996-95	V6 3.3L		34	600	2010	V6 3.8L		34	600	
2001-00	V8 5.3L Optional		78	690	<b>Crossfire</b>					2010	V6 4.0L		34	600	
2000-99	V8 5.7L Optional		78	690	2008	V6 3.2L	39	48	700	2009-08	V6 3.3L	71	34	600	
2000	V8 5.7L		78	600	2007-06	V6 3.2L	39	48	640	2009-08	V6 3.8L	71	34	600	
1999	V8 5.7L Police & Optional		78	770	2005-05	V6 3.2L	39	48	700	2009-08	V6 4.0L	71	34	600	
1999	V8 5.7L Primary Battery		78	600	2004	V6 3.2L	39	48	580	2007	V6 3.3L		34	600	
1999	V8 6.5L Diesel	2	78	690	<b>Grand Voyager</b>					2007	V6 3.8L		34	600	
1998-97	V8 6.5L Diesel	2	78	600	2000	V6 3.0L		34	500	2007	V6 3.8L		34	600	
1998-95	V8 5.7L		78	600	2000	V6 3.3L		34	500	2006-96	V6 3.3L		34	500	
1996-95	V8 6.5L Diesel	2	78	770	<b>Intrepid</b>					2006-95	V6 3.8L Optional		34	600	
<b>Tracker</b>					2004-98	V6 2.7L		34	500	2006-04	V6 3.3L Optional		34	600	
2004-01	V6 2.5L		85	600	2004-00	V6 3.5L		34	600	2006-03	V6 3.8L		34	500	
2003	L4 2.0L		85	600	2001-98	V6 3.2L		34	600	2001	V6 3.8L		34	500	
2002-99	L4 1.6L		85	550	1997-95	V6 3.3L		34	600	1997	V6 3.8L		34	600	
2002-99	L4 2.0L		85	550	1997-95	V6 3.5L		34	600	<b>Voyager</b>					
1998	L4 1.6L		26R	500	<b>LeBaron</b>					2003-01	V6 3.3L		34	600	
<b>Trailblazer</b>					1995	V6 3.0L		34	500	2003-00	L4 2.4L		34	600	
2009-06	V8 6.0L		40	78	600	<b>LHS</b>					2000	V6 3.0L		34	500
2009-02	L6 4.2L		40	78	600	2001-99	V6 3.5L		34	600	2000	V6 3.3L		34	500
2008-06	V8 5.3L		40	78	600	1997-95	V6 3.5L		34	600	2000	V6 3.3L Optional		34	600
<b>Trailblazer EXT</b>					<b>Neon</b>					<b>DAEWOO</b>					
2006-03	V8 5.3L		40	78	600	2002-00	L4 2.0L		26R	450	<b>Lanos</b>				
2006-02	L6 4.2L		40	78	600	<b>New Yorker</b>					2002-99	L4 1.5L	11	86	525
<b>Traverse</b>					1996-95	V6 3.5L		34	600	2002-99	L4 1.6L	11	86	525	
2014-10	V6 3.6L	54	48	660	<b>Pacifica</b>					<b>Leganza</b>					
2009	V6 3.6L	54	48	730	2008-07	V6 4.0L		34	600	2002-01	L4 2.2L	11	86	620	
<b>Trax</b>					2008-05	V6 3.8L		34	600	2000-99	L4 2.2L	11	86	630	
2014-13	L4 1.4L		47	525	2006-05	V6 3.5L		34	600	<b>Nubira</b>					
<b>Uplander</b>					2004	V6 3.5L		34	500	2002-01	L4 2.0L		11	86	620
2009-06	V6 3.9L		34	600	<b>Prowler</b>					2000	L4 2.0L		11	86	630
2006-05	V6 3.5L		34	600	2002-01	V6 3.5L		34	525	1999	L4 2.0L		86	630	
<b>Venture</b>					<b>PT Cruiser</b>					<b>DODGE</b>					
2005-97	V6 3.4L		78	600	2010-03	L4 2.4L		26R	510	<b>Avenger</b>					
<b>Volt</b>					2002-01	L4 2.4L		26R	540	2014-11	V6 3.6L		86	525	
2014-13	L4 1.4L Hybrid	45,54	N/A	0	<b>Sebring</b>					2014-10	L4 2.4L		86	525	
2012-11	L4 1.4L Hybrid	45	N/A	0	2010	L4 2.4L		86	525	2010	V6 2.7L		86	525	
<b>CHRYSLER</b>					2010	V6 2.7L		86	525	2010	V6 3.5L		86	525	
<b>200</b>					2010	V6 3.5L		86	525	2009-08	L4 2.4L	71	86	525	
2014-11	L4 2.4L		86	525	2009-08	L4 2.4L	71	86	525	2009-08	V6 2.7L	71	86	525	
2014-11	V6 3.6L		86	525	2009-08	V6 2.7L	71	86	525	2009-08	V6 3.5L	71	86	525	
<b>300</b>					2009-08	V6 3.5L	71	86	525	2000-95	V6 2.5L		86	525	
2014-12	V8 6.4L	54	94R	730	2007	L4 2.4L		86	525	1999-98	L4 2.0L		86	525	
2014-11	V6 3.6L	54	94R	730	2007	V6 2.7L		86	525	1997-95	L4 2.0L AT		86	525	
2014-10	V8 5.7L	54	94R	730	2007	V6 3.5L		86	525	1997-95	L4 2.0L MT		86	430	
2010	V6 2.7L	54	94R	730	2006	L4 2.4L		75	510	<b>B1500</b>					
2010	V6 3.5L	54	94R	730	2006	V6 2.7L		75	510	1998-96	V6 3.9L		27	600	
2010	V8 6.1L	54	94R	730	2005-01	L4 2.4L Convertible or Sedan		75	510	1998-96	V6 3.9L Optional		27	750	
2009-08	V6 2.7L	54,71	94R	730	2005-01	L4 2.4L Coupe		86	525	1998-96	V8 5.2L		27	600	
2009-08	V6 3.5L	54,71	94R	730	2005-01	V6 2.7L Convertible or Sedan		75	510	1998-96	V8 5.2L Optional		27	750	
2009-08	V8 5.7L	54,71	94R	730	2005-01	V6 2.7L Coupe		86	525	1998	V8 5.9L		27	600	
2009-08	V8 6.1L	54,71	94R	730	2005-01	V6 3.0L Convertible or Sedan		75	510	1998	V8 5.9L Optional		27	750	
2007-05	V6 2.7L	54	94R	730	2005-01	V6 3.0L Coupe		75	510	1995	V6 3.9L Cutaway	16	27	810	
2007-05	V6 3.5L	54	94R	730	2005-01	V6 3.0L Coupe		86	525	1995	V6 3.9L ex. Cutaway		27	600	
2007-05	V8 5.7L	54	94R	730	2000-95	V6 2.5L Conv.		75	510	1995	V6 3.9L ex. Cutaway Opt.		27	750	
2007-05	V8 6.1L	54	94R	730	2000-95	V6 2.5L ex. Conv.		86	525	1995	V8 5.2L Cutaway	16	27	810	
<b>300M</b>					1999-98	L4 2.0L Conv.		75	510	1995	V8 5.2L ex. Cutaway		27	600	
2004-99	V6 3.5L		34	600	1999-98	L4 2.0L ex. Conv.		86	525	1995	V8 5.2L ex. Cutaway Opt.		27	750	
<b>Aspen</b>					1998	L4 2.4L Conv.		75	510	<b>B2500</b>					
2009-08	V8 4.7L	71	65	750	1998	L4 2.4L ex. Conv.		75	510	1998-96	V8 5.2L		27	600	
2009-08	V8 5.7L	71	65	750	1998	L4 2.4L ex. Conv., MT		86	525	1998-96	V8 5.2L Optional		27	750	
2007	V8 4.7L		65	750	1997-96	L4 2.0L ex. Conv., MT		86	430	1998-96	V8 5.9L		27	600	
2007	V8 5.7L		65	750	1997-96	L4 2.4L ex. Conv., AT		86	525	1998-96	V8 5.9L Optional		27	750	
<b>Cirrus</b>					1997-96	L4 2.4L ex. Conv., MT		86	430	1997-96	V6 3.9L		27	600	
2000-99	L4 2.4L		75	510	1997-96	L4 2.4L ex. Conv., MT		86	430	1997-96	V6 3.9L Optional		27	750	
2000-95	V6 2.5L		75	510											
2000	L4 2.0L		75	510											

# Passenger Car & Light Truck

YEAR	ENGINE/OPTIONS	FOOT NOTE	GROUP/TYPE NO.	O.E. CCA (@0°F)	YEAR	ENGINE/OPTIONS	FOOT NOTE	GROUP/TYPE NO.	O.E. CCA (@0°F)	YEAR	ENGINE/OPTIONS	FOOT NOTE	GROUP/TYPE NO.	O.E. CCA (@0°F)
<b>DODGE (Cont.)</b>					<b>DODGE (Cont.)</b>					<b>DODGE (Cont.)</b>				
<b>B2500 (Cont.)</b>					<b>Charger (Cont.)</b>					<b>Grand Caravan</b>				
1995	V6 3.9L Cutaway	16	27	810	2009-08	V6 2.7L	54,71	94R	730	2014-12	V6 3.6L		94R	730
1995	V6 3.9L ex. Cutaway		27	600	2009-08	V6 3.5L ex. Police	54,71	94R	730	2011	V6 3.6L		94R	700
1995	V6 3.9L ex. Cutaway Opt.		27	750	2009-08	V8 5.7L ex. Police	54,71	94R	730	2010	V6 3.3L		34	600
1995	V8 5.2L Cutaway	16	27	810	2009-08	V8 6.1L ex. Police	54,71	94R	730	2010	V6 3.8L		34	600
1995	V8 5.2L ex. Cutaway		27	600	2009	V6 3.5L Police	54,71	49	800	2010	V6 4.0L		34	600
1995	V8 5.2L ex. Cutaway Opt.		27	750	2009	V8 5.7L Police	54,71	49	800	2009-08	V6 3.3L	71	34	600
1995	V8 5.9L Cutaway	16	27	810	2009	V8 6.1L Police	54,71	49	800	2009-08	V6 3.8L	71	34	600
1995	V8 5.9L ex. Cutaway		27	600	2008	V6 3.5L Police	54,71	49	850	2009-08	V6 4.0L	71	34	600
1995	V8 5.9L ex. Cutaway Opt.		27	750	2008	V8 5.7L Police	54,71	49	850	2007	V6 3.3L		34	600
1995	V8 5.9L ex. Cutaway Opt.		27	750	2008	V8 6.1L Police	54,71	49	850	2007	V6 3.8L		34	600
<b>B3500</b>					2007-06	V6 2.7L	54	94R	730	2006-95	V6 3.3L		34	500
1998-96	V8 5.2L		27	600	2007-06	V6 3.5L ex. Police	54	94R	730	2006-04	V6 3.8L Optional		34	600
1998-96	V8 5.2L Optional		27	750	2007-06	V6 3.5L Police	54	49	850	2006-03	V6 3.3L Optional		34	600
1998-96	V8 5.9L		27	600	2007-06	V8 5.7L ex. Police	54	94R	730	2006-03	V6 3.8L		34	500
1998-96	V8 5.9L Optional		27	750	2007-06	V8 5.7L Police	54	49	850	2002-95	V6 3.8L		34	600
1995	V8 5.2L Cutaway	16	27	810	2007-06	V8 6.1L ex. Police	54	94R	730	2001	V6 3.3L Optional		34	600
1995	V8 5.2L ex. Cutaway		27	600	2007-06	V8 6.1L Police	54	49	850	2000-95	V6 3.0L		34	500
1995	V8 5.2L ex. Cutaway Opt.		27	750	<b>Coit</b>					1999-95	V6 3.0L Optional		34	685
1995	V8 5.9L Cutaway	16	27	810	1995	L4 1.5L Canada		24	580	1999-95	V6 3.3L Optional		34	685
1995	V8 5.9L ex. Cutaway		27	600	1995	L4 1.5L U.S.		51	435	1999-95	V6 3.8L Optional		34	685
1995	V8 5.9L ex. Cutaway Opt.		27	750	<b>Dakota</b>					1997-96	L4 2.4L		34	600
<b>Caliber</b>					2010	V6 3.7L		65	600	1997-96	L4 2.4L Optional		34	685
2012-10	L4 2.0L		86	525	2010	V6 3.7L Optional		65	750	<b>Intrepid</b>				
2011-10	L4 2.4L		86	525	2010	V8 4.7L		65	600	2004-98	V6 2.7L		34	500
2009-08	L4 1.8L	71	86	525	2010	V8 4.7L Optional		65	750	2004-00	V6 3.5L		34	600
2009-08	L4 2.0L	71	86	525	2010	V8 4.7L Optional		65	750	2001-98	V6 3.2L		34	600
2009-08	L4 2.4L	71	86	525	2009-08	V6 3.7L	71	65	600	1997-95	V6 3.3L		34	600
2007	L4 1.8L		86	525	2009-08	V8 4.7L	71	65	600	1997-95	V6 3.5L		34	600
2007	L4 2.0L		86	525	2009	V6 3.7L Optional	71	65	750	<b>Journey</b>				
2007	L4 2.4L		86	525	2009	V8 4.7L Optional	71	65	750	2014-11	V6 3.6L		86	525
<b>Caravan</b>					2007-06	V6 3.7L		65	600	2014-09	L4 2.4L		86	525
2007	L4 2.4L		34	600	2007-06	V8 4.7L		65	600	2010-09	V6 3.5L		86	525
2007	V6 3.3L		34	600	2006	V6 3.7L Optional		65	650	<b>Magnum</b>				
2006-95	V6 3.3L		34	500	2006	V8 4.7L Optional		65	650	2008-06	V8 6.1L	54	94R	730
2006-05	L4 2.4L Optional		34	600	2005-04	V6 3.7L		27	600	2008-05	V6 2.7L	54	94R	730
2006-04	V6 3.3L Optional		34	600	2005-00	V8 4.7L		27	600	2008-05	V6 3.5L	54	94R	730
2006-03	L4 2.4L		34	500	2004-01	V8 4.7L Optional		27	750	2008-05	V8 5.7L	54	94R	730
2003	L4 2.4L Optional		34	600	2003-98	V8 5.9L		27	600	<b>Neon</b>				
2002-96	L4 2.4L		34	600	2003-98	V8 5.9L Optional		27	750	2005-03	L4 2.4L Turbo		26R	450
2001	V6 3.3L Optional		34	600	2003-95	V6 3.9L		27	600	2005-00	L4 2.0L		26R	450
2000-95	V6 3.0L		34	500	2003-95	V6 3.9L Optional		27	750	1999-95	L4 2.0L	35	58	450
1999-96	L4 2.4L Optional		34	685	2002-95	L4 2.5L		27	600	<b>Nitro</b>				
1999-96	V6 3.8L		34	600	1999-95	L4 2.5L Optional		27	750	2011-10	V6 3.7L		34	600
1999-96	V6 3.8L Optional		34	685	1999-95	V8 5.2L		27	600	2011-10	V6 4.0L		34	600
1999-95	V6 3.0L Optional		34	685	1999-95	V8 5.2L Optional		27	750	2009-08	V6 3.7L	71	34	600
1999-95	V6 3.3L Optional		34	685	<b>Dart</b>					2009-08	V6 4.0L	71	34	600
1995	L4 2.5L		34	600	2014-13	L4 2.0L ex. SE		48	600	2007	V6 3.7L		34	600
1995	L4 2.5L Optional		34	685	2014	L4 1.4L		47	600	2007	V6 4.0L		34	600
<b>Challenger</b>					2014	L4 2.0L SE		47	600	2007	V6 3.7L		34	600
2014-11	V6 3.6L	54	94R	730	2014	L4 2.4L	47,54	48	600	2007	V6 4.0L		34	600
2014-11	V8 6.4L	54	94R	730	2013	L4 1.4L		48	600	<b>Ram 1500</b>				
2014-10	V8 5.7L	54	94R	730	2013	L4 2.0L SE		47	500	2010	V6 3.7L		94R	700
2010	V6 3.5L	54	94R	730	2013	L4 2.4L		48	600	2010	V8 4.7L		94R	700
2010	V8 6.1L	54	94R	730	<b>Durango</b>					2010	V8 5.7L		94R	700
2009-08	V8 6.1L	54,71	94R	730	2014	V6 3.6L	47,54	94R	730	2009	V6 3.7L Mexico Built	71	65	700
2009	V6 3.5L	54,71	94R	730	2014	V8 5.7L	47,54	94R	800	2009	V6 3.7L US Built	71	94R	700
2009	V8 5.7L	54,71	94R	730	2013-11	V6 3.6L	47,54	94R	700	2009	V8 4.7L Mexico Built	71	65	700
<b>Charger</b>					2013-11	V8 5.7L	47,54	94R	700	2009	V8 4.7L US Built	71	94R	700
2014-12	V8 6.4L ex. Police	54	94R	730	2009	V6 3.7L	71	65	750	2009	V8 5.7L Mexico Built	71	65	700
2014-11	V6 3.6L ex. Police	54	94R	730	2009	V8 4.7L	71	65	750	2009	V8 5.7L Mexico Built	71	65	700
2014-11	V6 3.6L Police	54	49	800	2009	V8 5.7L	71	65	750	2009	V8 4.7L US Built	71	94R	700
2014-11	V8 5.7L Police	54	49	800	2008	V6 3.7L	71	65	600	2009	V8 5.7L Mexico Built	71	65	700
2014-10	V8 5.7L ex. Police	54	94R	730	2008	V8 4.7L	71	65	600	2009	V8 5.7L US Built	71	94R	700
2013-12	V8 6.4L Police	54	49	800	2008	V8 4.7L	71	65	600	2008	V6 3.7L	71	65	600
2010	V6 2.7L	54	94R	730	2008	V8 5.7L	71	65	600	2008	V8 4.7L	71	65	600
2010	V6 3.5L ex. Police	54	94R	730	2007-04	V6 3.7L	65	600	2008	V8 5.7L Mexico Built	71	65	650	
2010	V6 3.5L Police	54	49	800	2007-04	V8 4.7L	65	600	2008	V8 5.7L Mexico Built, Optional	71	65	750	
2010	V8 5.7L Police	54	49	850	2006-04	V6 3.7L Optional	65	750	2008	V8 5.7L US Built	71	94R	625	
2010	V8 6.1L ex. Police	54	94R	730	2006	V8 4.7L Optional	65	750	2008	V8 5.7L US Built, Optional	71	94R	730	
2010	V8 6.1L Police	54	49	850	2003-98	V8 5.9L	27	600	2007-06	V6 3.7L		65	600	
<b>Charger (Cont.)</b>					2003-00	V8 4.7L	27	600	2007-03	V8 5.7L		65	600	
2010	V8 6.1L Police	54	49	850	2003-00	V8 4.7L	27	600	2007-03	V8 5.7L Optional		65	750	
2010	V8 6.1L Police	54	49	850	2000-98	V8 5.2L	27	600	2007	V8 4.7L		65	750	
2010	V8 6.1L Police	54	49	850	2000-98	V8 5.2L Optional	27	750	2006-03	V6 3.7L Optional		65	750	
2010	V8 6.1L Police	54	49	850	1999-98	V6 3.9L	27	600	2006-03	V8 4.7L Optional		65	750	
2010	V8 6.1L Police	54	49	850	1999-98	V6 3.9L Optional	27	750	2006	V10 8.3L		65	600	
2010	V8 6.1L Police	54	49	850					2006	V10 8.3L Optional		65	750	

# Passenger Car & Light Truck

YEAR	ENGINE/ OPTIONS	FOOT NOTE	GROUP/ TYPE NO.	O.E. CCA (@0°F)	YEAR	ENGINE/ OPTIONS	FOOT NOTE	GROUP/ TYPE NO.	O.E. CCA (@0°F)	YEAR	ENGINE/ OPTIONS	FOOT NOTE	GROUP/ TYPE NO.	O.E. CCA (@0°F)
<b>DODGE (Cont.)</b>					<b>DODGE (Cont.)</b>					<b>EAGLE (Cont.)</b>				
<b>Ram 1500 (Cont.)</b>					<b>Ram 3500 (Cont.)</b>					<b>Summit (Cont.)</b>				
2006	V8 4.7L		65	600	2008	V8 5.7L US Built	71	94R	625	1996-95	L4 2.4L Wagon		24	490
2005-04	V10 8.3L		65	750	2008	V8 5.7L US Built, Optional	71	94R	730	<b>Talon</b>				
2005-04	V6 3.7L		65	650	2007-03	L6 5.9L Diesel	2	65	750	1998-95	L4 2.0L AT		86	525
2005	V8 4.7L		65	650	2007-03	V8 5.7L		65	600	1998-95	L4 2.0L MT		86	430
2004-03	V8 4.7L		65	600	2007-03	V8 5.7L Optional		65	750	1998-95	L4 2.0L Turbo		86	525
2003	V6 3.7L		65	600	2007	L6 6.7L Diesel	2	65	750	<b>Vision</b>				
2003	V8 5.9L		27	600	2003	V10 8.0L		65	750	1997-95	V6 3.3L		34	600
2003	V8 5.9L Optional		27	750	2002	L6 5.9L Diesel, Early or Optional	2	27	750	1997-95	V6 3.5L		34	600
2002	V6 3.7L Early or Optional		27	750	2002	L6 5.9L Diesel, Late	2	65	650	<b>FERRARI</b>				
2002	V6 3.7L Late		65	650	2002	V10 8.0L Early or Optional		27	750	<b>348 Spider</b>				
2002	V8 4.7L Early or Optional		27	750	2002	V10 8.0L Late		65	650	1995	V8 3.4L		34R	0
2002	V8 4.7L Late		65	650	2002	V8 5.9L Early or Optional		27	750	<b>360</b>				
2002	V8 5.9L Early or Optional		27	750	2002	V8 5.9L Late		65	650	2005-00	V8 3.6L	54,66	34R	570
2002	V8 5.9L Late		65	650	2001-95	L6 5.9L Diesel	2	27	750	<b>458 Italia</b>				
2001-95	V6 3.9L		27	600	2001-95	V10 8.0L		27	750	2012	V8 4.5L	47,54,66	48	760
2001-95	V6 3.9L Optional		27	750	2001-95	V8 5.9L		27	600	2010	V8 4.5L	47,54,66	48	760
2001-95	V8 5.2L		27	600	2001-95	V8 5.9L Optional		27	750	<b>575 M Maranello</b>				
2001-95	V8 5.2L Optional		27	750	<b>Ram 3500 Van</b>					2005	V12 5.7L	66	34R	680
2001-95	V8 5.9L		27	600	2003-99	V8 5.2L		27	600	<b>599 GTB</b>				
2001-95	V8 5.9L Optional		27	750	2003-99	V8 5.2L Optional		27	750	2009-07	V12 6.0L	54,66	34R	800
<b>Ram 1500 Van</b>					2003-99	V8 5.9L		27	600	<b>612 Scaglietti</b>				
2003-99	V6 3.9L		27	600	2003-99	V8 5.9L Optional		27	750	2010-05	V12 5.7L	54,66	34R	850
2003-99	V6 3.9L Optional		27	750	<b>Ram 4500</b>					<b>California</b>				
2003-99	V8 5.2L		27	600	2010	L6 6.7L Diesel	2	94R	730	2012-09	V8 4.3L	54,66	34R	850
2003-99	V8 5.2L Optional		27	750	2009	L6 6.7L Diesel	2,71	65	750	<b>F430</b>				
2003-99	V8 5.9L		27	600	2008	L6 6.7L	2,71	65	800	2009-06	V8 4.3L	54,66	34R	760
2003-99	V8 5.9L Optional		27	750	2008	L6 6.7L Diesel	2,71	65	800	<b>Superamerica</b>				
<b>Ram 2500</b>					<b>Ram 5500</b>					2005	V12 5.7L	66	34R	850
2010	L6 6.7L Diesel	2	94R	730	2010	L6 6.7L Diesel	2	94R	730	<b>FIAT</b>				
2010	V8 5.7L		94R	700	2009	L6 6.7L Diesel	2,71	65	750	<b>500</b>				
2009-08	L6 5.9L Diesel	2,71	65	750	2008	L6 6.7L	2,71	65	800	2014-12	L4 1.4L		47	500
2009-08	L6 6.7L Diesel	2,71	65	750	2008	L6 6.7L Diesel	2,71	65	800	<b>FORD</b>				
2009	V8 5.7L	71	65	700	<b>Spirit</b>					<b>Aerostar</b>				
2008	V8 5.7L Mexico Built	71	65	650	1995	L4 2.5L		34	600	1997-95	V6 3.0L		65	650
2008	V8 5.7L Mexico Built, Optional	71	65	750	1995	V6 3.0L		34	500	1997-95	V6 4.0L		65	650
2008	V8 5.7L US Built	71	94R	625	<b>Sprinter 2500</b>					<b>Aspire</b>				
2008	V8 5.7L US Built, Optional	71	94R	730	2009-07	V6 3.0L Diesel	54	49	850	1997-95	L4 1.3L		35	460
2007-03	L6 5.9L Diesel	2	65	750	2008-07	V6 3.5L	54	49	850	<b>Bronco</b>				
2007-03	V8 5.7L		65	600	2006-03	L5 2.7L Diesel	54	49	850	1996-95	V8 5.0L		65	650
2007-03	V8 5.7L Optional		65	750	<b>Sprinter 3500</b>					1996-95	V8 5.8L		65	650
2007	L6 6.7L Diesel	2	65	750	2009-07	V6 3.0L Diesel	54	49	850	<b>C-Max</b>				
2003	V10 8.0L		65	750	2008-07	V6 3.5L	54	49	850	2014-13	L4 2.0L Hybrid	54	67R	390
2002	L6 5.9L Diesel, Early or Optional	2	65	750	2006-03	L5 2.7L Diesel	54	49	850	<b>Contour</b>				
2002	L6 5.9L Diesel, Late	2	65	750	<b>Stealth</b>					2000-98	L4 2.0L		40R	590
2002	V10 8.0L Early or Optional		27	750	1996-95	V6 3.0L		25	520	2000-98	V6 2.5L		40R	590
2002	V10 8.0L Late		65	650	<b>Stratus</b>					1997-95	L4 2.0L		96R	590
2002	V8 5.9L Early or Optional		27	750	2006-01	L4 2.4L Coupe		86	525	1997-95	L4 2.0L		40R	650
2002	V8 5.9L Late		65	650	2006-01	L4 2.4L Sedan		75	510	1997-95	L4 2.0L Optional		40R	650
2001-95	L6 5.9L Diesel	2	27	750	2006-01	V6 2.7L Coupe		86	525	1997-95	V6 2.5L		40R	650
2001-95	V10 8.0L		27	750	2005-01	V6 3.0L Coupe		86	525	<b>Crown Victoria</b>				
2001-95	V8 5.9L		27	600	2005-01	V6 3.0L Sedan		75	510	2011-09	V8 4.6L Optional		65	750
2001-95	V8 5.9L Optional		27	750	2002	V6 2.7L Sedan		86	510	2011-07	V8 4.6L		65	650
1996-95	V8 5.2L		27	600	2001	V6 2.7L Sedan		75	510	2006-98	V8 4.6L U.S.		65	650
1996-95	V8 5.2L Optional		27	750	2000-95	L4 2.0L		86	510	2006-95	V8 4.6L Canada or Optional		65	750
<b>Ram 2500 Van</b>					2000-95	L4 2.4L		75	510	1997-96	V8 4.6L Natural Gas		65	850
2003-99	V8 5.2L		27	600	2000-95	V6 2.5L		86	510	1997	V8 4.6L Police Package		65	850
2003-99	V8 5.2L Optional		27	750	<b>SX 2.0</b>					1997	V8 4.6L U.S.		59	540
2003-99	V8 5.9L		27	600	2005-03	L4 2.0L		26R	450	1996-95	V8 4.6L HWS or Police		65	850
2003-99	V8 5.9L Optional		27	750	<b>Viper</b>					1996	V8 4.6L Early		58	540
2001	V6 3.9L		27	600	2010-08	V10 8.4L	54	34	600	1996	V8 4.6L Late		59	540
<b>Ram 3500</b>					2006-03	V10 8.3L		34	600	1995	V8 4.6L U.S.		58	540
2010	L6 6.7L Diesel	2	94R	730	2002-97	V10 8.0L		78	650	<b>E-150</b>				
2009-08	L6 5.9L Diesel	2,71	65	750	1996-95	V10 8.0L		78	770	2014-07	V8 4.6L Auxiliary	31	65	750
2009-08	L6 6.7L Diesel	2,71	65	750	<b>EAGLE</b>					2014-07	V8 5.4L Auxiliary	31	65	750
2009	V8 5.7L	71	65	700	<b>Summit</b>					2014-03	V8 4.6L Primary Battery		65	650
2008	V8 5.7L Mexico Built	71	65	650	1996-95	L4 1.5L		51	435	2014-03	V8 5.4L Primary Battery		65	650
2008	V8 5.7L Mexico Built, Optional	71	65	750	1996-95	L4 1.8L ex. Wagon		51	435					
					1996-95	L4 1.8L Wagon		25	355					
					1996-95	L4 2.4L ex. Wagon		51	435					

# Passenger Car & Light Truck

YEAR	ENGINE/ OPTIONS	FOOT NOTE	GROUP/ TYPE NO.	O.E. CCA (@0°F)	YEAR	ENGINE/ OPTIONS	FOOT NOTE	GROUP/ TYPE NO.	O.E. CCA (@0°F)	YEAR	ENGINE/ OPTIONS	FOOT NOTE	GROUP/ TYPE NO.	O.E. CCA (@0°F)
<b>FORD (Cont.)</b>					<b>FORD (Cont.)</b>					<b>FORD (Cont.)</b>				
<b>E-150 (Cont.)</b>					<b>E-250 Econoline (Cont.)</b>					<b>E-350 Econoline Club Wagon (Cont.)</b>				
2006-03	V8 4.6L Auxiliary	31	65	625	2002-97	V8 5.4L Primary Battery		65	650	2000-97	V10 6.8L Primary Battery		65	750
2006-03	V8 5.4L Auxiliary	31	65	625	2000-97	V6 4.2L Optional		65	750	1998-97	V10 6.8L Auxiliary	31	65	625
2003	V6 4.2L Auxiliary	31	65	625	2000-97	V8 5.4L Optional		65	750	1998	V8 5.4L Primary Battery		65	750
2003	V6 4.2L Primary Battery		65	650	1997	V8 4.6L Auxiliary	31	65	625	1996-95	L6 4.9L Auxiliary	31	50	500
<b>E-150 Club Wagon</b>					1997	V8 4.6L Optional		65	750	1996-95	L6 4.9L Optional		65	850
2005-03	V8 4.6L		65	650	1997	V8 4.6L Primary Battery		65	650	1996-95	L6 4.9L Primary Battery		65	650
2005-03	V8 5.4L Auxiliary	31	65	625	1996-95	L6 4.9L Auxiliary	31	50	500	1996-95	V8 5.8L Auxiliary	31	50	500
2005-03	V8 5.4L Primary Battery		65	650	1996-95	L6 4.9L Optional		65	850	1996-95	V8 5.8L Optional		65	850
2003	V6 4.2L		65	650	1996-95	L6 4.9L Primary Battery		65	650	1996-95	V8 5.8L Primary Battery		65	650
<b>E-150 Econoline</b>					1996-95	V8 5.8L Auxiliary	31	50	500	1996-95	V8 7.3L Diesel, Left side		65	850
2002-97	V6 4.2L Auxiliary	31	65	625	1996-95	V8 5.8L Optional		65	850	1996-95	V8 7.3L Diesel, Right side		50	600
2002-97	V6 4.2L Primary Battery		65	650	1996-95	V8 5.8L Primary Battery		65	650	1996-95	V8 7.5L Auxiliary	31	50	500
2002-97	V8 4.6L Auxiliary	31	65	625	<b>E-250 Super Duty</b>					1996-95	V8 7.5L Optional		65	850
2002-97	V8 4.6L Primary Battery		65	650	2005-04	V8 5.4L Auxiliary	31	65	625	1996-95	V8 7.5L Primary Battery		65	650
2002-97	V8 5.4L Auxiliary	31	65	625	2005-04	V8 5.4L Primary Battery		65	650	<b>E-350 Super Duty</b>				
2002-97	V8 5.4L Primary Battery		65	650	<b>E-350</b>					2014-09	V8 5.4L Auxiliary	31	65	750
2000-97	V6 4.2L Optional		65	750	2003	V10 6.8L Auxiliary	31	65	625	2014-09	V8 5.4L Primary Battery		65	650
2000-97	V8 4.6L Optional		65	750	2003	V10 6.8L Primary Battery		65	650	2014-07	V10 6.8L Auxiliary	31	65	750
2000-97	V8 5.4L Optional		65	750	2003	V8 5.4L Auxiliary	31	65	625	2014-04	V10 6.8L Primary Battery		65	650
1996-95	L6 4.9L Auxiliary	31	50	500	2003	V8 5.4L Primary Battery		65	650	2010-04	V8 6.0L Diesel	2	65	750
1996-95	L6 4.9L Optional		65	850	2003	V8 7.3L Diesel	2	65	750	2008-07	V8 5.4L	2	65	650
1996-95	L6 4.9L Primary Battery		65	650	<b>E-350 Club Wagon</b>					2006-04	V10 6.8L Auxiliary	31	65	625
1996-95	V8 5.0L Auxiliary	31	50	500	2005-04	V8 6.0L Diesel	2	65	750	2006-04	V8 5.4L Auxiliary	31	65	625
1996-95	V8 5.0L Optional		65	850	2005-03	V8 5.4L Auxiliary	31	65	625	2006-04	V8 5.4L Primary Battery		65	650
1996-95	V8 5.0L Primary Battery		65	650	2005-03	V8 5.4L Primary Battery		65	650	<b>E-450 Econoline Super Duty</b>				
1996-95	V8 5.8L Auxiliary	31	50	500	2005	V10 6.8L Auxiliary	31	65	625	2002-00	V10 6.8L Auxiliary	31	65	625
1996-95	V8 5.8L Optional		65	850	2005	V10 6.8L Primary Battery		65	650	2002-00	V10 6.8L Primary Battery		65	750
1996-95	V8 5.8L Primary Battery		65	650	2003	V10 6.8L Auxiliary	31	65	625	2002-00	V8 5.4L Auxiliary	31	65	625
<b>E-150 Econoline Club Wagon</b>					2003	V10 6.8L Primary Battery		65	650	2002-00	V8 5.4L Optional		65	750
2002-99	V6 4.2L		65	650	2003	V10 6.8L Primary Battery		65	650	2002-00	V8 5.4L Primary Battery		65	650
2002-97	V6 4.2L Optional		65	750	2003	V8 7.3L Diesel	2	65	750	2002-00	V8 7.3L Diesel	2	65	750
2002-97	V8 4.6L Auxiliary	31	65	625	<b>E-350 Econoline</b>					<b>E-450 Econoline Super Duty Stripped</b>				
2002-97	V8 4.6L Optional		65	750	2002-99	V8 5.4L Primary Battery		65	650	2002-00	V10 6.8L Auxiliary	31	65	625
2002-97	V8 4.6L Primary Battery		65	650	2002-97	V10 6.8L Auxiliary	31	65	625	2002-00	V10 6.8L Primary Battery		65	750
2002-97	V8 5.4L Auxiliary	31	65	625	2002-97	V10 6.8L Primary Battery		65	750	2002-00	V8 5.4L Auxiliary	31	65	625
2002-97	V8 5.4L Optional		65	750	2002-97	V8 5.4L Auxiliary	31	65	625	2002-00	V8 5.4L Optional		65	750
2002-97	V8 5.4L Primary Battery		65	650	2002-97	V8 5.4L Optional		65	750	2002-00	V8 5.4L Primary Battery		65	650
1998-97	V6 4.2L Auxiliary	31	65	625	2002-97	V8 7.3L Diesel	2	65	750	2002-00	V8 7.3L Diesel	2	65	750
1998-97	V6 4.2L Primary Battery		65	650	1998	V8 5.4L Primary Battery		65	750	<b>E-450 Super Duty</b>				
1996-95	L6 4.9L Auxiliary	31	50	500	1996-95	L6 4.9L Auxiliary	31	50	500	2014-07	V10 6.8L Auxiliary	31	65	750
1996-95	L6 4.9L Optional		65	850	1996-95	L6 4.9L Optional		65	850	2014-07	V8 5.4L Auxiliary	31	65	750
1996-95	L6 4.9L Primary Battery		65	650	1996-95	L6 4.9L Primary Battery		65	650	2014-06	V8 5.4L Primary Battery		65	650
1996-95	V8 5.0L Auxiliary	31	50	500	1996-95	V8 5.8L Auxiliary	31	50	500	2014-03	V10 6.8L Primary Battery		65	650
1996-95	V8 5.0L Optional		65	850	1996-95	V8 5.8L Optional		65	850	2010-04	V8 6.0L Diesel	2	65	750
1996-95	V8 5.0L Primary Battery		65	650	1996-95	V8 5.8L Primary Battery		65	650	2006-03	V10 6.8L Auxiliary	31	65	625
1996-95	V8 5.8L Auxiliary	31	50	500	1996-95	V8 7.3L Diesel, Left side		65	850	2006	V8 5.4L Auxiliary	31	65	625
1996-95	V8 5.8L Optional		65	850	1996-95	V8 7.3L Diesel, Right side		50	600	2004-03	V8 5.4L Auxiliary	31	65	625
1996-95	V8 5.8L Primary Battery		65	650	1996-95	V8 7.5L Auxiliary	31	50	500	2004-03	V8 5.4L Primary Battery		65	650
<b>E-250</b>					1996-95	V8 7.5L Optional		65	850	2003	V8 7.3L Diesel	2	65	750
2014-07	V8 4.6L Auxiliary	31	65	750	1996-95	V8 7.5L Primary Battery		65	650	<b>E-450 Super Duty Stripped Chassis</b>				
2014-07	V8 5.4L Auxiliary	31	65	750	<b>E-350 Econoline Club Wagon</b>					2003	V10 6.8L Auxiliary	31	65	625
2014-03	V8 4.6L Primary Battery		65	650	2002-99	V10 6.8L Auxiliary	31	65	650	2003	V10 6.8L Primary Battery		65	650
2014-03	V8 5.4L Primary Battery		65	650	2002-99	V8 5.4L Primary Battery		65	650	2003	V8 5.4L Auxiliary	31	65	625
2006-03	V8 4.6L Auxiliary	31	65	625	2002-97	V8 5.4L Optional		65	750	2003	V8 5.4L Primary Battery		65	650
2006-03	V8 5.4L Auxiliary	31	65	625	2002-97	V8 7.3L Diesel	2	65	750	2003	V8 7.3L Diesel	2	65	750
2003	V6 4.2L Auxiliary	31	65	625	2002	V10 6.8L Primary Battery		65	750	<b>E-550 Econoline Super Duty</b>				
2003	V6 4.2L Primary Battery		65	650	2002	V8 5.4L Auxiliary	31	65	650	2002	V10 6.8L Auxiliary	31	65	625
<b>E-250 Econoline</b>					2001-97	V8 5.4L Auxiliary	31	65	625	2002	V10 6.8L Primary Battery		65	750
2002-97	V6 4.2L Auxiliary	31	65	625	2001	V10 6.8L Primary Battery		65	650	2002	V8 7.3L Diesel	2	65	750
2002-97	V6 4.2L Primary Battery		65	650										
2002-97	V8 5.4L Auxiliary	31	65	625										

# Passenger Car & Light Truck

YEAR	ENGINE/ OPTIONS	FOOT NOTE	GROUP/ TYPE NO.	O.E. CCA (@0°F)	YEAR	ENGINE/ OPTIONS	FOOT NOTE	GROUP/ TYPE NO.	O.E. CCA (@0°F)	YEAR	ENGINE/ OPTIONS	FOOT NOTE	GROUP/ TYPE NO.	O.E. CCA (@0°F)
<b>FORD (Cont.)</b>					<b>FORD (Cont.)</b>					<b>FORD (Cont.)</b>				
<b>E-550 Super Duty</b>					<b>Explorer</b>					<b>F-250 (Cont.)</b>				
2003	V10 6.8L Auxiliary	31	65	625	2014	L4 2.0L w/o Power Code Remote Start		59	540	1997	V8 5.8L		59	540
2003	V10 6.8L Primary Battery		65	650	2014	L4 2.0L w/Power Code Remote Start		65	650	1997	V8 5.8L Optional		65	750
2003	V8 7.3L Diesel	2	65	750	2014	V6 3.5L w/o Power Code Remote Start		59	540	1997	V8 7.3L Diesel	2	65	750
<b>Econoline Super Duty</b>					<b>Explorer Sport Trac</b>					<b>F-250 Super Duty</b>				
1999-97	V10 6.8L Auxiliary	31	65	625	2010-07	V6 4.0L		65	650	2014-11	V8 6.2L		65	650
1999-97	V10 6.8L Primary Battery		65	750	2010-07	V8 4.6L		65	650	2014-11	V8 6.2L Optional		65	750
1999-97	V8 5.4L Auxiliary	31	65	625	2005-01	V6 4.0L		65	650	2014-11	V8 6.7L Diesel	2	65	750
1999-97	V8 5.4L Optional		65	750	<b>F Super Duty</b>					2010-99	V10 6.8L		65	650
1999-97	V8 5.4L Primary Battery		65	650	1997-95	V8 7.3L Diesel	2	65	750	2010-99	V10 6.8L Optional		65	750
1999-97	V8 7.3L Diesel	2	65	750	1997	V8 7.5L		59	540	2010-99	V8 5.4L Optional		65	750
1996	V8 5.8L Auxiliary	31	50	500	1997	V8 7.5L Optional		65	750	2010-08	V8 6.4L Diesel	2	65	750
1996	V8 5.8L Optional		65	850	1996-95	V8 7.3L Diesel	2	65	850	2010-00	V8 5.4L		65	650
1996	V8 5.8L Primary Battery		65	650	1996-95	V8 7.5L		65	650	2007	V8 6.0L Diesel	2	65	650
1996	V8 7.3L Diesel, Left side		65	850	1996-95	V8 7.5L Optional		65	850	2006-03	V8 6.0L Diesel	2	65	750
1996	V8 7.3L Diesel, Right side		50	600	<b>F-150</b>					2003-99	V8 7.3L Diesel	2	65	750
1996	V8 7.5L Auxiliary	31	50	500	2014-11	V6 3.5L		65	750	<b>F-350</b>				
1996	V8 7.5L Optional		65	850	2014-11	V6 3.7L		65	750	1997	V8 5.8L		59	540
1996	V8 7.5L Primary Battery		65	650	2014-11	V8 5.0L		65	750	1997	V8 5.8L Optional		65	750
<b>Edge</b>					2014-11	V6 3.5L w/o Power Code Remote Start		59	540	1997	V8 7.3L Diesel	2	65	750
2014-12	L4 2.0L w/o Power Code Remote Start		59	540	2014-11	V6 3.5L w/Power Code Remote Start		65	650	1997	V8 7.5L		59	540
2014-12	L4 2.0L w/Power Code Remote Start		65	650	2014-11	V8 5.4L Optional		65	650	1997	V8 7.5L Optional		65	750
2014-11	V6 3.5L w/o Power Code Remote Start		59	540	2010-08	V8 4.6L Optional		65	650	1996-95	L6 4.9L		65	650
2014-11	V6 3.5L w/Power Code Remote Start		65	650	2010-07	V8 4.6L		59	540	1996-95	L6 4.9L Optional		65	850
2014-11	V6 3.7L w/o Power Code Remote Start		59	540	2010-07	V8 5.4L		59	540	1996-95	V8 5.8L		65	650
2014-11	V6 3.7L w/Power Code Remote Start		65	650	2008-07	V6 4.2L		59	540	1996-95	V8 5.8L Optional		65	850
2010	V6 3.5L		36R	650	2008	V6 4.2L Optional		65	650	1996-95	V8 7.3L Diesel	2	65	850
2009	V6 3.5L		36R	540	2006-97	V8 4.6L Canada or Optional		65	650	1996-95	V8 7.5L		65	650
2009	V6 3.5L Optional		36R	600	2006-97	V8 4.6L U.S.		59	540	1996-95	V8 7.5L Optional		65	850
2008	V6 3.5L		36R	600	2006-97	V8 5.4L Canada or Optional		65	650	<b>F-350 Super Duty</b>				
2007	V6 3.5L		36R	580	2006-97	V8 5.4L U.S.		59	540	2014-11	V8 6.2L		65	650
<b>Escape</b>					2006-05	V6 4.2L Canada or Optional		65	650	2014-11	V8 6.2L Optional		65	750
2014-13	L4 1.6L		96R	500	2006-05	V6 4.2L U.S.		59	540	2014-11	V8 6.7L Diesel	2	65	750
2014-13	L4 1.6L Optional		96R	590	2006-05	V6 4.2L U.S.		59	540	2010-99	V10 6.8L		65	650
2014-13	L4 2.0L		96R	500	2003-97	V6 4.2L Canada or Optional		65	650	2010-99	V10 6.8L Optional		65	750
2014-13	L4 2.0L Optional		96R	590	2003-97	V6 4.2L U.S.		59	540	2010-99	V8 5.4L		65	650
2014-13	L4 2.5L		96R	500	1997	V6 4.2L Canada & Optional		65	650	2010-99	V8 5.4L Optional		65	750
2014-13	L4 2.5L Optional		96R	590	1996-95	L6 4.9L		65	650	2010-08	V8 6.4L Diesel	2	65	750
2012-11	L4 2.5L Gas		96R	590	1996-95	L6 4.9L Optional		65	850	2007	V8 6.0L Diesel	2	65	650
2012-11	V6 3.0L		96R	590	1996-95	V8 5.0L		65	650	2006-03	V8 6.0L Diesel	2	65	750
2012-09	L4 2.5L Hybrid		96R	500	1996-95	V8 5.0L Optional		65	850	2003-99	V8 7.3L Diesel	2	65	750
2010	L4 2.5L Gas		40R	650	1996-95	V8 5.8L		65	650	<b>F-450 Super Duty</b>				
2010	L4 2.5L Gas, Optional		96R	590	1996-95	V8 5.8L Optional		65	850	2014-11	V8 6.7L Diesel	2	65	750
2010	V6 3.0L		40R	650	<b>F-150 Heritage</b>					2014-10	V10 6.8L		65	650
2010	V6 3.0L Optional		96R	590	2004	V6 4.2L Canada or Optional		65	650	2014-10	V10 6.8L Optional		65	750
2009-01	V6 3.0L		40R	590	2004	V6 4.2L U.S.		59	540	2010-08	V8 6.4L Diesel	2	65	750
2009	L4 2.5L Gas		40R	590	2004	V8 4.6L Canada or Optional		65	650	2008-99	V10 6.8L		65	650
2008-05	L4 2.3L Gas		40R	590	2004	V8 4.6L U.S.		59	540	2008-99	V10 6.8L Optional		65	750
2008-05	L4 2.3L Hybrid		96R	500	2004	V8 5.4L Canada or Optional		65	650	2007-03	V8 6.0L Diesel	2	65	750
2004-01	L4 2.0L		96R	500	2004	V8 5.4L U.S.		59	540	2003-99	V8 7.3L Diesel	2	65	750
<b>Escort</b>					<b>F-250</b>					<b>F53</b>				
2003-98	L4 2.0L		58	500	1999-97	V8 4.6L Opt. Over 8500lbs.		65	650	2014-00	V10 6.8L		65	750
1997	L4 2.0L		58	540	1999-97	V8 4.6L Under 8500lbs		59	540	1997	V8 7.5L		59	540
1996-95	L4 1.8L		35	540	1999-97	V8 5.4L Under 8500lbs		59	540	1996-95	V8 7.5L		65	650
1996-95	L4 1.9L		35	460	1999	V8 5.4L Optional		65	750	<b>F-550 Super Duty</b>				
<b>Excursion</b>					2005-03	V8 6.0L Diesel	2	65	750	2014-99	V10 6.8L		65	650
2005-00	V10 6.8L		65	750	2005-00	V8 5.4L		65	750	2014-99	V10 6.8L Optional		65	750
2005-00	V8 5.4L		65	750	2003-00	V8 7.3L Diesel	2	65	750	2014-11	V8 6.7L Diesel	2	65	750
<b>Expedition</b>					2003-00	V8 7.3L Diesel	2	65	750	2010-08	V8 6.4L Diesel	2	65	750
2014-97	V8 5.4L		65	650	1999-97	V8 5.4L Under 8500lbs		59	540	2007-03	V8 6.0L Diesel	2	65	750
2014-07	V8 5.4L Optional		65	750	1999	V8 5.4L Optional		65	750	2003-99	V8 7.3L Diesel	2	65	750
2004-97	V8 4.6L		65	650	1999	V8 5.4L Over 8500lbs		65	650	<b>Fiesta</b>				
2001-97	V8 4.6L Optional		65	750	1998-97	V8 5.4L Opt. Over 8500lbs.		65	750	2014-11	L4 1.6L		96R	500
2001-97	V8 5.4L Optional		65	750						2014	L3 1.0L		96R	500
										2014	L3 1.0L Optional		96R	590
										2014	L4 1.6L Optional		96R	590

# Passenger Car & Light Truck

YEAR	ENGINE/ OPTIONS	FOOT NOTE	GROUP/ TYPE NO.	O.E. CCA (@0°F)	YEAR	ENGINE/ OPTIONS	FOOT NOTE	GROUP/ TYPE NO.	O.E. CCA (@0°F)	YEAR	ENGINE/ OPTIONS	FOOT NOTE	GROUP/ TYPE NO.	O.E. CCA (@0°F)
<b>FORD (Cont.)</b>					<b>FORD (Cont.)</b>					<b>FORD (Cont.)</b>				
<b>Five Hundred</b>					<b>Mustang (Cont.)</b>					<b>Windstar</b>				
2007-05	V6 3.0L		36R	540	2006-05	V8 4.6L Optional		40R	590	2003-97	V6 3.8L Optional	48	65	750
2006-05	V6 3.0L Optional		36R	600	2004-97	V6 3.8L		59	540	2003-95	V6 3.8L		65	650
<b>Flex</b>					<b>Police Interceptor Sedan</b>					<b>Sprinter 2500</b>				
2014-10	V6 3.5L ex. EcoBoost		65	650	2014-13	V6 3.5L ex. EcoBoost		59	540	2014-07	V6 3.0L Diesel	54	49	850
2014-10	V6 3.5L w/EcoBoost		65	750	2014-13	V6 3.5L		65	650	2014	L4 2.1L Diesel	54	49	850
2009	V6 3.5L		65	750	2014-13	V6 3.7L		59	540	2008-07	V6 3.5L	54	49	850
<b>Focus</b>					<b>Police Interceptor Utility</b>					<b>Sprinter 3500</b>				
2014-13	L4 2.0L ex. EcoBoost		96R	500	2014-13	V6 3.7L		59	540	2014-07	V6 3.0L Diesel	54	49	850
2014-13	L4 2.0L w/EcoBoost		96R	590	<b>Probe</b>					2014	L4 2.1L Diesel	54	49	850
2014-12	Electric		67R	390	1997-95	L4 2.0L		58R	580	2008-07	V6 3.5L	54	49	850
2012	L4 2.0L AT		96R	590	1997-95	V6 2.5L		58R	580	2006-02	L5 2.7L Diesel	54	49	850
2012	L4 2.0L MT		96R	500	<b>Ranger</b>					<b>Tracker</b>				
2011-05	L4 2.0L		96R	500	2011-97	V6 4.0L		59	540	1997-95	L4 1.6L		35	310
2007-05	L4 2.0L w/Emerson Heater or Premium Radio		40R	590	2011-01	L4 2.3L		59	540	1997-95	L4 1.8L		35	310
2007-05	L4 2.3L w/Emerson Heater or Premium Radio		40R	590	2008-97	V6 3.0L		59	540	<b>Prizm</b>				
2007-03	L4 2.3L		96R	500	2001-98	L4 2.5L		59	540	1997-95	L4 1.6L		35	310
2004-03	L4 2.0L ex. Zetec		40R	590	1997-95	L4 2.3L Optional		65	650	<b>Metro</b>				
2004-03	L4 2.0L Zetec		96R	500	1997-95	V6 3.0L Optional		65	650	1997-95	L3 1.0L		26R	390
2002-00	L4 2.0L ex. Zetec		96R	500	1997	L4 2.3L		59	540	1997-95	L4 1.3L		26R	390
2002-00	L4 2.0L Zetec		40R	590	1997	V6 4.0L Optional		65	650	<b>Prizm</b>				
<b>Freestar</b>					<b>Taurus</b>					<b>Acadia</b>				
2007-04	V6 3.9L		59	540	2014-13	L4 2.0L		59	540	2014-10	V6 3.6L	54	48	660
2007-04	V6 3.9L Optional		65	650	2014-13	V6 3.5L Police		65	750	2009-07	V6 3.6L	54	48	730
2007-04	V6 4.2L		59	540	2014-10	V6 3.5L ex. SHO		59	540	<b>C1500</b>				
2007-04	V6 4.2L Optional		65	650	2014-10	V6 3.5L SHO		65	650	1999-95	V8 5.0L		78	600
<b>Freestyle</b>					<b>Thunderbird</b>					<b>C1500 Suburban</b>				
2007-05	V6 3.0L		36R	540	2009-08	V6 3.5L		59	540	1999-95	V8 5.7L		78	600
2006-05	V6 3.0L Optional		36R	600	2007-06	V6 3.0L		36R	540	1999	V8 5.0L Optional		78	690
<b>Fusion</b>					<b>Transit Connect</b>					<b>C2500</b>				
2014-13	L4 1.6L Start Stop	69	48	760	2013-12	Electric		96R	500	2000-99	V8 5.7L Optional		78	690
2014-13	L4 1.6L w/o Power Code Remote Start		90	500	2013-10	L4 2.0L		96R	590	2000-99	V8 7.4L Optional		78	690
2014-13	L4 1.6L w/Power Code Remote Start		90	590	<b>Taurus X</b>					<b>C2500 Suburban</b>				
2014-13	L4 2.0L Gas		90	500	2009-08	V6 3.5L		59	540	2000-99	V8 7.4L Primary Battery		78	600
2014-13	L4 2.0L Gas, Optional		90	590	2005-00	V6 3.0L DOHC, Opt. & Canada		36R	600	2000-99	V8 7.4L Optional		78	690
2014-13	L4 2.0L Hybrid	54	67R	390	2005	V6 3.0L OHV		36R	600	2000-99	V8 7.4L Optional		78	690
2014-13	L4 2.5L w/o Power Code Remote Start		90	500	2004-01	V6 3.0L OHV		36R	540	1999	V8 5.7L Optional		78	690
2014-13	L4 2.5L w/Power Code Remote Start		90	590	2004-01	V6 3.0L OHV, Optional		36R	600	1999	V8 5.7L Diesel & Optional	2	78	690
2014	L4 1.5L Start Stop	69	48	760	2000-96	V6 3.0L SOHC		58R	540	1999	V8 6.5L Diesel & Optional	2	78	690
2014	L4 1.5L w/o Power Code Remote Start		90	500	1999-96	V8 3.4L SHO		36R	650	1997	V8 6.5L Diesel	2	78	690
2014	L4 1.5L w/Power Code Remote Start		90	590	1999	V6 3.0L DOHC or Optional		36R	650	1996-95	V8 6.5L Diesel	2	78	770
2012-10	L4 2.5L Gas		96R	500	1998-96	V6 3.0L DOHC, Opt. & Canada		36R	650	<b>C1500</b>				
2012-10	L4 2.5L Hybrid		67R	390	2005	V6 3.0L OHV		36R	600	1999-98	V8 6.5L Diesel	2	78	600
2012-10	V6 3.0L		96R	500	2004-01	V6 3.0L OHV		36R	540	1999-95	V8 5.7L		78	600
2012-10	V6 3.5L		96R	500	2004-01	V6 3.0L OHV, Optional		36R	600	1999	V8 5.7L Optional		78	690
2009-07	L4 2.3L		96R	500	2000-96	V6 3.0L SOHC		58R	540	1999	V8 6.5L Diesel & Optional	2	78	690
2009-06	V6 3.0L		40R	590	1999-96	V8 3.4L SHO		36R	650	1997	V8 6.5L Diesel	2	78	690
2006	L4 2.3L		40R	590	1999	V6 3.0L DOHC or Optional		36R	650	1996-95	V8 6.5L Diesel	2	78	770
<b>Mustang</b>					<b>Transit Connect</b>					<b>C2500</b>				
2014-13	V8 5.8L		96R	590	2013-12	Electric		96R	500	2000-99	V8 5.7L Optional		78	690
2014-12	V8 5.0L BOSS		96R	500	2013-10	L4 2.0L		96R	590	2000-99	V8 7.4L Optional		78	690
2014-12	V8 5.0L ex. BOSS		96R	590	<b>Thunderbird</b>					<b>C2500 Suburban</b>				
2014-11	V6 3.7L		96R	590	2005-02	V8 3.9L	54	66	650	2000-99	V8 7.4L Primary Battery		78	600
2012-11	V8 5.4L		96R	590	1997-95	V6 3.8L U.S. Opt. or Canada		65	650	2000-97	V8 6.5L Diesel	2	78	600
2011	V8 5.0L		96R	590	1997-95	V8 4.6L		65	650	2000-95	V8 5.7L		78	600
2010-08	V8 4.6L		96R	500	1997	V6 3.8L U.S.		59	540	2000-99	V8 7.4L		78	600
2010-07	V8 5.4L		40R	590	1996	V6 3.8L U.S., Early		58	540	2000-97	V8 6.5L Diesel	2	78	600
2010-05	V6 4.0L		96R	500	1996	V6 3.8L U.S., Late		59	540	2000-95	V8 5.7L		78	600
2009-08	V6 4.0L w/High Electrical Content		40R	590	1995	V6 3.8L ex. Police		65	650	2000	V8 6.5L Diesel & Optional	2	78	690
2009-08	V8 4.6L w/High Electrical Content		40R	590	1995	V6 3.8L Police or Optional		65	850	1999	V8 6.5L Diesel & Optional	2	78	600
2007	V8 4.6L		40R	590	<b>Thunderbird</b>					<b>C2500</b>				
2006-05	V6 4.0L Optional		40R	590	2009-08	V6 3.5L		59	540	1999-95	V8 5.7L		78	600
2006-05	V8 4.6L		96R	500	<b>Thunderbird</b>					<b>C2500 Suburban</b>				

# Passenger Car & Light Truck

YEAR	ENGINE/ OPTIONS	FOOT NOTE	GROUP/ TYPE NO.	O.E. CCA (@0°F)	YEAR	ENGINE/ OPTIONS	FOOT NOTE	GROUP/ TYPE NO.	O.E. CCA (@0°F)	YEAR	ENGINE/ OPTIONS	FOOT NOTE	GROUP/ TYPE NO.	O.E. CCA (@0°F)
<b>GMC (Cont.)</b>					<b>GMC (Cont.)</b>					<b>GMC (Cont.)</b>				
<b>C3500</b>					<b>K2500 Suburban (Cont.)</b>					<b>Savana 3500 (Cont.)</b>				
2000-99	V8 5.7L Optional		78	690	1999	V8 5.7L Optional		78	690	2006	V8 6.6L Diesel	2	79	800
2000-99	V8 6.5L Diesel & Optional	2	78	690	1999	V8 6.5L Diesel & Optional	2	78	690	2005-03	V8 6.0L Optional		79	800
2000-99	V8 7.4L Optional		78	690	1999	V8 7.4L Optional		78	690	2004	V8 4.8L Optional		79	800
2000-97	V8 6.5L Diesel	2	78	600	1996-95	V8 6.5L Diesel	2	78	770	2002-99	V8 5.7L Optional		78	690
2000-95	V8 5.7L		78	600	<b>K3500</b>					2002-96	V8 5.7L		78	600
2000	V8 7.4L		78	600	2000-99	V8 5.7L Optional		78	690	2002-96	V8 6.5L Diesel	2	78	600
1999	V8 7.4L Primary Battery		78	600	2000-99	V8 6.5L Diesel & Optional	2	78	690	2002-01	V8 8.1L		78	600
1998-95	V8 7.4L		78	600	2000-99	V8 7.4L Optional		78	690	2002-01	V8 8.1L Optional		78	690
1996-95	V8 6.5L Diesel	2	78	770	2000-97	V8 6.5L Diesel	2	78	600	2000	V8 7.4L		78	600
<b>Canyon</b>					2000-95	V8 5.7L		78	600	2000	V8 7.4L Optional		78	690
2012-09	V8 5.3L	40	86	590	2000-95	V8 7.4L		78	600	1999	V8 7.4L		78	630
2012-08	L4 2.9L	40	86	590	1996-95	V8 6.5L Diesel	2	78	770	1998-96	V8 7.4L		78	600
2012-08	L5 3.7L	40	86	590	<b>P3500</b>					<b>Savana 4500</b>				
2007	L4 2.9L	11,40	86	640	1999-97	V6 4.3L		78	600	2014-10	V8 6.0L Optional		78	770
2007	L5 3.7L	11,40	86	590	1999-97	V6 4.3L Optional		78	690	2014-09	V8 6.0L		78	600
2006-04	L4 2.8L	11,40	86	640	1999-97	V8 5.7L		78	600	2014-09	V8 6.6L Diesel	2	78	770
2006-04	L5 3.5L	11,40	86	590	1999-97	V8 5.7L Optional		78	690	<b>Sierra 1500</b>				
<b>Envoy</b>					1999-95	V8 6.5L Diesel	2	78	600	2014-09	V6 4.3L Optional		48	730
2009-05	V8 5.3L	40	78	600	1999-95	V8 7.4L		78	600	2014-09	V8 5.3L Optional		48	730
2009-02	L6 4.2L	40	78	600	1996-95	V6 4.3L		75	525	2014-09	V8 6.2L Optional		48	730
<b>Envoy XL</b>					1996-95	V6 4.3L Optional		78	600	2014-08	V6 4.3L		48	615
2006-03	V8 5.3L	40	78	600	1996-95	V8 5.7L		75	525	2014-08	V8 5.3L		48	615
2006-02	L6 4.2L	40	78	600	1996-95	V8 5.7L Optional		78	600	2014-08	V8 6.2L		48	615
<b>Envoy XUV</b>					<b>Safari</b>					2013-09	V8 4.8L Optional		48	730
2005-04	L6 4.2L	40	78	600	2005-04	V6 4.3L Optional; w/SEO		78	770	2013-08	V8 4.8L		48	615
2005-04	V8 5.3L	40	78	600	2005-04	V6 4.3L Primary Battery		78	600	2013	V8 6.0L Hybrid		48	730
<b>G1500</b>					2003-95	V6 4.3L		78	600	2012-10	V8 6.0L Hybrid		48	615
1995	V6 4.3L		78	600	2003-02	V6 4.3L Optional		78	770	2012-10	V8 6.0L Hybrid, Optional		48	730
1995	V8 5.0L		78	600	<b>Savana 1500</b>					2009-08	V8 6.0L		48	615
<b>G2500</b>					2014-10	V6 4.3L Optional		78	770	2009	V8 6.0L Optional		48	730
1995	V6 4.3L		78	600	2014-10	V8 5.3L Optional		78	770	2007-07	V8 5.3L Early		78	600
1995	V8 5.0L		78	600	2014-06	V6 4.3L		78	600	2007-07	V8 5.3L Late		48	615
1995	V8 5.7L		78	600	2014-03	V8 5.3L		78	600	2007	V6 4.3L Early		78	600
1995	V8 6.5L Diesel	2	78	600	2005-04	V6 4.3L Optional; w/SEO		79	800	2007	V6 4.3L Late		48	615
<b>G3500</b>					2005-04	V6 4.3L Primary Battery		78	600	2007	V8 4.8L Early		78	600
1996-95	V8 5.7L	2	78	600	2005-03	V8 5.3L Optional		79	800	2007	V8 4.8L Late		48	615
1996-95	V8 6.5L Diesel		78	600	2003-96	V6 4.3L		78	600	2007	V8 6.0L Early		78	600
1996-95	V8 7.4L		78	600	2003	V6 4.3L Optional		79	800	2007	V8 6.0L Late		48	615
1995	V6 4.3L		78	600	2002-99	V6 4.3L Optional		78	690	2007	V8 6.2L Early		78	600
<b>Jimmy</b>					2002-99	V8 5.0L Optional		78	690	2007	V8 6.2L Late		48	615
2005-95	V6 4.3L		75	525	2002-99	V8 5.7L Optional		78	690	2006-99	V6 4.3L		78	600
2005-95	V6 4.3L Optional		75	690	2002-96	V8 5.0L		78	600	2006-99	V8 4.8L		78	600
<b>K1500</b>					2002-96	V8 5.7L		78	690	2006-99	V8 5.3L		78	600
1999-95	V8 5.0L		78	600	2002-96	V8 5.0L		78	600	2006-06	V8 5.3L Optional		78	690
1999-95	V8 5.7L		78	600	<b>Savana 2500</b>					2006-05	V8 6.0L Optional		78	690
1999	V8 5.0L Optional		78	690	2014-10	V8 4.8L Optional		78	770	2006-02	V8 6.0L		78	600
1999	V8 5.7L Optional		78	690	2014-10	V8 6.0L Optional		78	770	2006	V6 4.3L Optional		78	690
1998-97	V8 6.5L Diesel	2	78	600	2014-07	V8 6.6L Diesel	2	78	770	2006	V8 4.8L Optional		78	690
1998-95	V6 4.3L		78	600	2014-03	V8 4.8L		78	600	2005-99	V6 4.3L Optional		78	770
1996-95	V8 6.5L Diesel	2	78	770	2014-03	V8 6.0L		78	600	2005-99	V8 4.8L Optional		78	770
<b>K1500 Suburban</b>					2006	V8 6.6L Diesel	2	79	800	2005-04	V8 5.3L Optional		78	770
1999-97	V8 6.5L Diesel	2	78	600	2005-03	V8 4.8L Optional		79	800	2004-02	V8 6.0L Optional		78	770
1999-95	V8 5.7L		78	600	2005-03	V8 5.3L		78	600	2001-99	V8 5.3L Optional		78	770
1999	V8 5.7L Optional		78	690	2005-03	V8 5.3L Optional		79	800	<b>Sierra 1500 HD</b>				
1999	V8 6.5L Diesel & Optional	2	78	690	2005-03	V8 6.0L Optional		79	800	2007	V8 6.0L Early		78	600
1996-95	V8 6.5L Diesel	2	78	770	2005	V6 4.3L Optional; w/SEO		79	800	2007	V8 6.0L Late		48	615
<b>K2500</b>					2005	V6 4.3L Primary Battery		78	600	2006-05	V8 6.0L		78	600
2000-99	V8 5.7L Optional		78	690	2004-96	V6 4.3L		78	600	2006	V8 6.0L Optional		78	690
2000-99	V8 6.5L Diesel & Optional	2	78	690	2004-03	V6 4.3L Optional		79	800	2005	V8 6.0L Optional		78	770
2000-99	V8 7.4L Optional		78	690	2002-99	V6 4.3L Optional		78	690	2003-01	V8 6.0L		78	600
2000-97	V8 6.5L Diesel	2	78	600	2002-99	V8 5.0L Optional		78	690	2003-01	V8 6.0L Optional		78	770
2000-95	V8 5.7L		78	600	2002-99	V8 5.7L Optional		78	690	<b>Sierra 2500</b>				
2000-95	V8 7.4L		78	600	2002-96	V8 5.0L		78	600	2004-99	V8 6.0L		78	600
1998	V8 5.0L		78	600	2002-96	V8 5.7L		78	600	2004-99	V8 6.0L Optional		78	770
1996-95	V8 6.5L Diesel	2	78	770	2002-96	V8 5.7L		78	600	2000-99	V8 5.3L		78	600
1995	V6 4.3L		78	600	2002-96	V8 6.5L Diesel	2	78	600	2000-99	V8 5.3L Optional		78	770
1995	V8 5.0L		78	600	<b>Savana 3500</b>					<b>Sierra 2500 HD</b>				
<b>K2500 Suburban</b>					2014-10	V8 4.8L Optional		78	770	2014-08	V8 6.6L Diesel	2	48	730
1999-97	V8 6.5L Diesel	2	78	600	2014-10	V8 6.0L Optional		78	770	2014	V8 6.0L		94R	720
1999-95	V8 5.7L		78	600	2014-07	V8 6.6L Diesel	2	78	770	2013-11	V8 6.0L Optional		48	730
1999-95	V8 7.4L		78	600	2014-04	V8 4.8L		78	600	2013-08	V8 6.0L		48	615
1999-95	V8 7.4L		78	600	2014-03	V8 6.0L		78	600	2009	V8 6.0L Optional		48	730
										2007	V8 6.0L Early		78	600
										2007	V8 6.0L Late		48	615
										2007	V8 6.6L Diesel, Early	2	78	770

# Passenger Car & Light Truck

YEAR	ENGINE/ OPTIONS	FOOT NOTE	GROUP/ TYPE NO.	O.E. CCA (@0°F)	YEAR	ENGINE/ OPTIONS	FOOT NOTE	GROUP/ TYPE NO.	O.E. CCA (@0°F)	YEAR	ENGINE/ OPTIONS	FOOT NOTE	GROUP/ TYPE NO.	O.E. CCA (@0°F)
<b>GMC (Cont.)</b>					<b>GMC (Cont.)</b>					<b>HONDA (Cont.)</b>				
<b>Sierra 2500 HD (Cont.)</b>					<b>Yukon (Cont.)</b>					<b>Civic</b>				
2007	V8 6.6L Diesel, Late	2	48	730	2006-06	V8 5.3L Optional		78	690	2014	L4 1.8L		51R	410
2007	V8 8.1L Early		78	600	2006-01	V8 6.0L		78	600	2014	L4 2.4L		51R	410
2007	V8 8.1L Late		48	615	2006-00	V8 4.8L		78	600	2013-12	L4 1.5L Hybrid		151R	340
2006-03	V8 6.6L Diesel	2	78	770	2006-00	V8 5.3L		78	600	2013-12	L4 2.4L Canada		51R	410
2006-01	V8 6.0L		78	600	2006	V8 4.8L Optional		78	690	2013-12	L4 2.4L U.S.		51R	310
2006-01	V8 8.1L		78	600	2006	V8 6.0L Optional		78	690	2013-08	L4 1.8L Canada		51R	410
2006	V8 6.0L Optional		78	690	2005-03	V8 4.8L Optional		78	770	2013-08	L4 1.8L U.S.		51R	310
2006	V8 8.1L Optional		78	690	2005-03	V8 5.3L Optional		78	770	2011-08	L4 2.0L Canada		51R	410
2005-01	V8 6.0L Optional		78	770	2005	V8 6.0L Optional		78	770	2011-08	L4 2.0L U.S.		51R	310
2005	V8 8.1L Optional		78	770	2001-00	V8 4.8L Optional		78	690	2011-06	L4 1.3L Hybrid		151R	340
2004	V8 6.6L Diesel	2	78	600	2001-00	V8 5.3L Optional		78	690	2007-06	L4 1.8L		51R	435
2003	V8 8.1L Optional		78	770	2000-99	V8 5.7L Optional		78	690	2007	L4 2.0L		51R	440
2002-01	V8 6.6L Diesel	2	78	600	2000-99	V8 5.7L Primary Battery		78	600	2006-02	L4 2.0L		51R	435
2002-01	V8 6.6L Diesel, Optional	2	78	690	2000	V8 5.7L Police & Optional		78	770	2005-03	L4 1.3L Hybrid		51R	410
2002	V8 8.1L Optional		78	690	1999-95	V8 5.7L		78	600	2005-01	L4 1.7L		51	410
<b>Sierra 3500</b>					1999	V8 5.7L Police or Optional		78	770	2000-95	L4 1.6L		51R	410
2007	V8 6.0L Early		78	600	1997	V8 6.5L Diesel	2	78	600	1995	L4 1.5L		51R	410
2007	V8 6.0L Late		48	615	1996-95	V8 6.5L Diesel	2	78	770	<b>Civic del Sol</b>				
2007	V8 6.6L Diesel, Early	2	78	770	<b>Yukon XL 1500</b>					<b>Crosstour</b>				
2007	V8 6.6L Diesel, Late	2	48	730	2014-12	V8 5.3L		48	660	2014	L4 2.4L		51R	500
2007	V8 8.1L Early		78	600	2014-12	V8 6.2L		48	660	2014	V6 3.5L		24F	550
2007	V8 8.1L Late		48	615	2014-09	V8 5.3L Optional		48	730	2013-12	L4 2.4L Calif. & Canada		35	440
2006-03	V8 6.6L Diesel	2	78	770	2014-09	V8 6.2L Optional		48	730	2013-12	L4 2.4L U.S. ex. California		51R	410
2006-01	V8 6.0L		78	600	2011-07	V8 5.3L		48	615	2013-12	V6 3.5L	11	24F	550
2006-01	V8 8.1L		78	600	2011-07	V8 6.2L		48	615	<b>CR-V</b>				
2006	V8 6.0L Optional		78	690	2009-07	V8 6.0L		48	615	2014-02	L4 2.4L		51R	410
2006	V8 8.1L Optional		78	690	2009	V8 6.0L Optional		48	730	2001-97	L4 2.0L		51R	410
2005-03	V8 8.1L Optional		78	770	2006-01	V8 5.3L		78	600	<b>CR-Z</b>				
2005-01	V8 6.0L Optional		78	770	2006-01	V8 6.0L		78	600	2014-11	L4 1.5L Hybrid		151R	340
2004	V8 6.6L Diesel	2	78	600	2006	V8 5.3L Optional		78	690	<b>Element</b>				
2002-01	V8 6.6L Diesel	2	78	600	2006	V8 6.0L Optional		78	690	2011-03	L4 2.4L		51R	410
2002-01	V8 6.6L Diesel, Optional	2	78	690	2005-03	V8 5.3L Optional		78	770	<b>Fit</b>				
2002	V8 8.1L Optional		78	690	2005	V8 6.0L Optional		78	770	2014-13	Electric		151R	340
2001	V8 8.1L Optional		78	600	2001-00	V8 5.3L Optional		78	690	2014-07	L4 1.5L		151R	340
<b>Sierra 3500 HD</b>					2000	V8 5.3L Police & Optional		78	770	<b>Insight</b>				
2014-08	V8 6.6L Diesel	2	48	730	2000	V8 5.3L Primary Battery		78	600	2014-10	L4 1.3L Hybrid		151R	340
2014	V8 6.0L		94R	720	<b>Yukon XL 2500</b>					2006-00	L3 1.0L Hybrid		51	270
2013-11	V8 6.0L		48	615	2013-12	V8 6.0L		48	660	<b>Odyssey</b>				
2013-09	V8 6.0L Optional		48	730	2013-09	V8 6.0L Optional		48	730	2014-05	V6 3.5L	11	24F	550
2009-08	V8 6.0L		48	615	2011-07	V8 6.0L		48	615	2004-99	V6 3.5L		24F	550
2007	V8 6.0L Early	2	78	600	2006-01	V8 6.0L		78	600	1998	L4 2.3L		24F	550
2007	V8 6.0L Late	2	48	615	2006-01	V8 8.1L		78	600	1997-95	L4 2.2L		24F	550
2007	V8 6.6L Diesel, Early	2	78	600	2006	V8 6.0L Optional		78	690	<b>Passport</b>				
2007	V8 6.6L Diesel, Late	2	48	730	2006	V8 8.1L Optional		78	690	2002-98	V6 3.2L		24F	600
<b>Sierra C3</b>					2005-03	V8 6.0L Optional		78	770	1997-96	V6 3.2L		24	600
2001	V8 6.0L		78	600	2005-03	V8 8.1L Optional		78	770	1996	L4 2.6L		86	430
2001	V8 6.0L Optional		78	770	2001-00	V8 6.0L Optional		78	690	1996	L4 2.6L Optional		24	600
<b>Sonoma</b>					2001	V8 8.1L Optional		78	690	1995	L4 2.6L		25	380
2004-95	V6 4.3L		75	525	2000	V8 6.0L Police & Optional		78	770	1995	V6 3.2L AT		24	600
2004-95	V6 4.3L Optional		75	690	2000	V8 6.0L Primary Battery		78	600	1995	V6 3.2L MT		25	380
2003-96	L4 2.2L		75	525	<b>HONDA</b>					<b>Pilot</b>				
2002	L4 2.2L Optional		75	690	<b>Accord</b>					2014-03	V6 3.5L	11	24F	550
2000-95	L4 2.2L Optional		75	690	2014-08	V6 3.5L	11	24F	550	<b>Prelude</b>				
<b>Terrain</b>					2014	L4 2.0L Hybrid		51	500	2001-95	L4 2.2L		24F	550
2014-13	V6 3.6L		48	660	2014	L4 2.4L		51R	410	1996-95	L4 2.3L		24F	550
2014-10	L4 2.4L		47	525	2013-12	L4 2.4L U.S. ex. California		51R	410	<b>Ridgeline</b>				
2012	V6 3.0L		48	660	2013	L4 2.4L Calif. & Canada		35	440	2014-11	V6 3.5L		24F	550
2011-10	V6 3.0L		48	615	2012	L4 2.4L Canada & California		35	440	2010-07	V6 3.5L		24F	585
<b>Yukon</b>					2011-10	L4 2.4L		51R	410	2006	V6 3.5L		24F	550
2014-12	V8 5.3L		48	660	2009-03	L4 2.4L		51R	435	<b>S2000</b>				
2014-12	V8 6.2L		48	660	2007-03	L4 2.4L		35	440	2009-04	L4 2.2L		51	430
2014-09	V8 5.3L Optional		48	730	2002-98	V6 3.0L		35	450	2003-00	L4 2.0L		51	430
2014-09	V8 6.2L Optional		48	730	2002-98	L4 2.3L		35	450	<b>HUMMER</b>				
2013-12	V8 6.0L Hybrid		48	660	2002-98	V6 3.0L		24	500	<b>H1</b>				
2013-09	V8 6.0L Hybrid, Optional		48	730	1997-96	V6 2.7L		24	500	2006	V8 6.6L Diesel		79	840
2011-08	V8 6.0L Hybrid		48	615	1997-95	L4 2.2L		24F	550	2004-03	V8 6.5L Diesel		79	840
2011-07	V8 5.3L		48	615	1995	V6 2.7L		24F	550	2002	V8 6.5L Diesel		78	770
2011-07	V8 6.2L		48	615	<b>Accord Crosstour</b>					<b>H2</b>				
2009-07	V8 4.8L		48	615	2011-10	V6 3.5L	11	24F	550	2009-08	V8 6.2L		48	730
2009	V8 4.8L Optional		48	730										

# Passenger Car & Light Truck

YEAR	ENGINE/ OPTIONS	FOOT NOTE	GROUP/ TYPE NO.	O.E. CCA (@0°F)	YEAR	ENGINE/ OPTIONS	FOOT NOTE	GROUP/ TYPE NO.	O.E. CCA (@0°F)	YEAR	ENGINE/ OPTIONS	FOOT NOTE	GROUP/ TYPE NO.	O.E. CCA (@0°F)	
<b>HUMMER (Cont.)</b>					<b>HYUNDAI (Cont.)</b>					<b>INFINITI (Cont.)</b>					
<b>H2 (Cont.)</b>					<b>Santa Fe XL (Cont.)</b>					<b>I30</b>					
2007-03	V8 6.0L		79	840	2013	L4 2.4L		124R	600	2001-98	V6 3.0L		24F	585	
<b>H3</b>					<b>Sonata</b>					1997-96 V6 3.0L California					
2010	L5 3.7L	40	86	590	2014	L4 2.0L	69	48	760	1997-96	V6 3.0L Canada or Optional		24F	585	
2010	V8 5.3L	40	86	590	2014	L4 2.4L	69	48	760	1997-96	V6 3.0L U.S.		35	360	
2009	L5 3.7L	11,40	86	590	2013-11	L4 2.0L		124R	600	<b>I35</b>					
2009	V8 5.3L	11,40	86	590	2013-06	L4 2.4L		124R	600	2004-03	V6 3.5L		24F	445	
2008-07	L5 3.7L	11,40	86	640	2010	V6 3.3L		124R	700	2002	V6 3.5L		24F	585	
2008	V8 5.3L	11,40	86	640	2009-06	V6 3.3L		124R	600	<b>J30</b>					
2006	L5 3.5L	11,40	86	640	2005-03	L4 2.4L		124R	560	1997-95	V6 3.0L		24	585	
<b>H3T</b>					<b>2005-02 V6 2.7L</b>					<b>J30</b>					
2010	L5 3.7L	40	86	590	2002-99	L4 2.4L		124R	550	<b>JX35</b>					
2010	V8 5.3L	40	86	590	2001	V6 2.5L		124R	600	2013	V6 3.5L		24F	720	
2009	L5 3.7L	11,40	86	590	2000-99	V6 2.5L		124R	540	<b>M35</b>					
2009	V8 5.3L	11,40	86	590	1998-95	L4 2.0L		25	420	2010-06	V6 3.5L		24F	700	
<b>HYUNDAI</b>					<b>1998-95 L4 2.0L Optional</b>					<b>M35h</b>					
<b>Accent</b>					<b>1998-95 V6 3.0L</b>					<b>2013-12 V6 3.5L Hybrid</b>					
2014	L4 1.6L		48	550	<b>Tiburon</b>					54	24F	700	<b>M37</b>		
2013-01	L4 1.6L		121R	500	2008-03	L4 2.0L		124R	600	<b>2013-11 V6 3.7L</b>					
2003-01	L4 1.5L		121R	500	2008-03	V6 2.7L		124R	600	<b>M45</b>					
2000-98	L4 1.5L		121R	435	2001-97	L4 2.0L		124R	600	2010-06	V8 4.5L		24F	750	
1997-95	L4 1.5L		121R	410	1997	L4 1.8L		124R	600	2004	V8 4.5L		24	490	
1997-95	L4 1.5L Optional		121R	580	<b>Tucson</b>					2003	V8 4.5L		24	585	
<b>Azera</b>					<b>2014-11 L4 2.0L</b>					<b>M56</b>					
2014-07	V6 3.3L		124R	600	2014-10	L4 2.4L		124R	600	2013-11	V8 5.6L		24F	750	
2011-06	V6 3.8L		124R	600	2009-05	L4 2.0L		124R	600	<b>Q45</b>					
<b>Elantra</b>					<b>2009-05 V6 2.7L</b>					<b>2006-02 V8 4.5L</b>					
2014-11	L4 1.8L		47	550	<b>Veloster</b>					2001-97	V8 4.1L		24	585	
2014	L4 2.0L		47	550	2014-12	L4 1.6L Non-Turbo		121R	550	1996-95	V8 4.5L		27	625	
2012-11	L4 2.0L		47	550	2014-12	L4 1.6L Turbo		47	550	<b>QX4</b>					
2010	L4 2.0L		121R	600	<b>Veracruz</b>					2003	V6 3.5L		24	490	
2009-07	L4 2.0L		121R	550	2012-09	V6 3.8L		124R	660	2002	V6 3.5L		25	360	
2006	L4 2.0L		124R	500	2008-07	V6 3.8L		124R	600	2001	V6 3.5L		24	490	
2005-04	L4 2.0L		124R	560	<b>XG300</b>					2000-97	V6 3.3L Heated Seats & Canada, Optional		24	450	
2003-99	L4 2.0L		124R	550	2001	V6 3.0L		124R	600	2000-97	V6 3.3L U.S.		25	360	
1998-97	L4 1.8L	45	N/A	600	<b>XG350</b>					<b>QX56</b>					
1996-95	L4 1.8L Canada or Optional		24	540	2005-02	V6 3.5L		124R	600	2013-11	V8 5.6L	68	27	710	
1996-95	L4 1.8L U.S.		25	435	<b>INFINITI</b>					2010-04	V8 5.6L	68	27F	710	
1995	L4 1.6L Canada or Optional		24	540	<b>EX35</b>					<b>ISUZU</b>					
1995	L4 1.6L U.S.		25	435	<b>2012-08 V6 3.5L</b>					<b>Amigo</b>					
<b>Elantra Coupe</b>					<b>EX37</b>					<b>2000-98 L4 2.2L</b>					
2014	L4 2.0L		47	550	2013	V6 3.7L		24F	720	2000-98	V6 3.2L		24F	600	
2013	L4 1.8L		47	550	<b>FX35</b>					<b>Ascender</b>					
<b>Elantra GT</b>					<b>2012-09 V6 3.5L</b>					<b>2008-03 L6 4.2L</b>					
2014	L4 2.0L		47	550	2008-07	V6 3.5L w/Intelligent Key		24F	750	2006-03	V8 5.3L	40	78	600	
2013	L4 1.8L		47	550	2008-07	V6 3.5L w/o Intelligent Key		35	550	<b>Axiom</b>					
<b>Entourage</b>					<b>2006-03 V6 3.5L</b>					<b>2004-02 V6 3.5L</b>					
2010-07	V6 3.8L		124R	600	<b>FX37</b>					<b>Hombre</b>					
<b>Equus</b>					<b>2013 V6 3.7L</b>					<b>2000-97 V6 4.3L</b>					
2014-12	V8 5.0L	54	49	740	<b>FX45</b>					2000-97	V6 4.3L Optional		75	525	
2011	V8 4.6L		49	740	2008-06	V8 4.5L w/Intelligent Key		24F	750	2000-96	L4 2.2L		75	525	
<b>Genesis</b>					<b>2008-06 V8 4.5L w/o Intelligent Key</b>					<b>2000-96 L4 2.2L</b>					
2014-09	V6 3.8L	54	49	740	2005-03	V8 4.5L		35	550	2000-96	L4 2.2L Optional		75	690	
2014	V8 5.0L	47,54	95R	950	<b>FX50</b>					<b>i-280</b>					
2013-12	V8 5.0L		124	600	2013-09	V8 5.0L		24F	720	2006	L4 2.8L	11,40	86	640	
2012-09	V8 4.6L	54	49	740	<b>G20</b>					<b>i-290</b>					
<b>Genesis Coupe</b>					<b>2002-99 L4 2.0L</b>					<b>2008 L4 2.9L</b>					
2014-10	L4 2.0L		124R	600	1996-95	L4 2.0L California		24F	585	2007	L4 2.9L	11,40	86	640	
2014-10	V6 3.8L		124R	600	1996-95	L4 2.0L ex. California		24F	585	<b>i-350</b>					
<b>Santa Fe</b>					<b>G25</b>					<b>2006 L5 3.5L</b>					
2014-13	L4 2.0L		124R	600	2012-11	V6 2.5L		24F	720	<b>i-370</b>					
2014-13	V6 3.3L		124R	600	<b>G35</b>					2008	L5 3.7L	40	86	640	
2014-10	L4 2.4L		124R	600	2008	V6 3.5L		35	550	2007	L5 3.7L	11,40	86	640	
2012-10	V6 3.5L		124R	600	2007	V6 3.5L		24F	550	<b>Oasis</b>					
2009-07	V6 3.3L		124R	600	2006-03	V6 3.5L		35	490	1999-98	L4 2.3L		24F	550	
2009-01	V6 2.7L		124R	600	<b>G37</b>					1997-96	L4 2.2L		24F	550	
2006-03	L4 2.4L		124R	600	2014-08	V6 3.7L		35	585	<b>Pickup</b>					
2006-03	V6 3.5L		124R	600	<b>2014-08 V6 3.7L</b>					1995	L4 2.3L AT		24	600	
2002	L4 2.4L		124R	550	<b>2014-08 V6 3.7L</b>					1995	L4 2.6L		24	600	
2001	L4 2.4L		124R	660	<b>2014-08 V6 3.7L</b>					<b>Rodeo</b>					
<b>Santa Fe XL</b>					<b>2014-08 V6 3.7L</b>					<b>2004 V6 3.2L</b>					
2014	V6 3.3L		124R	600	<b>2014-08 V6 3.7L</b>										
2013	L4 2.0L		124R	600	<b>2014-08 V6 3.7L</b>										

# Passenger Car & Light Truck

YEAR	ENGINE/ OPTIONS	FOOT NOTE	GROUP/ TYPE NO.	O.E. CCA (@0°F)	YEAR	ENGINE/ OPTIONS	FOOT NOTE	GROUP/ TYPE NO.	O.E. CCA (@0°F)	YEAR	ENGINE/ OPTIONS	FOOT NOTE	GROUP/ TYPE NO.	O.E. CCA (@0°F)
<b>ISUZU (Cont.)</b>					<b>JAGUAR (Cont.)</b>					<b>JEEP (Cont.)</b>				
<b>Rodeo (Cont.)</b>					<b>XJR (Cont.)</b>					<b>Grand Cherokee (Cont.)</b>				
2004	V6 3.5L		24	650	2003-98	V8 4.0L		49	680	2008	V8 5.7L Early	71	94R	730
2003-02	V6 3.2L Canada or Optional		27F	625	1997	L6 4.0L		49	680	2008	V8 5.7L Late	71	94R	625
2003-02	V6 3.2L U.S.		24F	600	1996-95	L6 4.0L		47	590	2008	V8 6.1L Early	71	94R	730
2003	L4 2.2L Canada or Optional		27F	625	<b>XJS</b>					2008	V8 6.1L Late	71	94R	625
2003	L4 2.2L U.S.		24F	600	1996-95	L6 4.0L		48	600	2007-06	V8 6.1L		94R	730
2002-98	L4 2.2L		24F	600	1995	V12 6.0L	6,54	47	590	2007-05	V6 3.7L		94R	730
2001	V6 3.2L Canada & Optional		27F	625	<b>XK</b>					2007-05	V8 4.7L		94R	730
2000-98	V6 3.2L		24F	600	2013-10	V8 5.0L	54	49	800	2007-05	V8 5.7L		94R	730
1997-95	L4 2.6L		86	430	2009-07	V8 4.2L	54	93	800	2007	V6 3.0L Diesel		94R	730
1997	V6 3.2L		24	600	<b>XK8</b>					2004-99	L6 4.0L		65	625
1996-95	V6 3.2L AT		24	600	2006-04	V8 4.2L	54	49	750	2004-99	V8 4.7L		65	625
1996-95	V6 3.2L MT		86	430	2003	V8 4.2L		49	680	1998-95	L6 4.0L		34	600
1996	L4 2.6L Optional		24	600	2002-97	V8 4.0L		49	680	1998	V8 5.9L		34	600
<b>Rodeo Sport</b>					<b>XKR</b>					<b>Liberty</b>				
2003	L4 2.2L Canada or Optional		27F	625	2013-10	V8 5.0L	54	49	800	2012-10	V6 3.7L		34	600
2003	L4 2.2L U.S.		24F	600	2009-07	V8 4.2L	54	93	800	2009-08	V6 3.7L	71	34	600
2003	V6 3.2L Canada or Optional		27F	625	2006-04	V8 4.2L	54	49	750	2007-03	V6 3.7L		34	600
2003	V6 3.2L U.S.		24F	600	2003	V8 4.2L		49	680	2006-05	L4 2.8L Diesel	45	N/A	800
2002-01	L4 2.2L		24F	600	2002-00	V8 4.0L		49	680	2005-03	L4 2.4L		34	600
2002-01	V6 3.2L		24F	600	<b>XKR-S</b>					2002	L4 2.4L		86	525
<b>Trooper</b>					<b>X-Type</b>					<b>Patriot</b>				
2002-01	V6 3.5L AT or Optional		27	625	2008-07	V6 3.0L		47	520	2014-10	L4 2.0L		86	525
2002-01	V6 3.5L MT		24	585	2006-04	V6 3.0L		94R	700	2014-10	L4 2.4L		86	525
2000-98	V6 3.5L AT		27	625	2005-04	V6 2.5L		94R	700	2009-08	L4 2.0L	71	86	525
2000-98	V6 3.5L MT		24	580	2003-02	V6 2.5L		92	720	2009-08	L4 2.4L	71	86	525
1997-95	V6 3.2L AT		27	625	2003-02	V6 3.0L		92	720	2007	L4 2.0L		86	525
1997-95	V6 3.2L MT		24	580	<b>JEEP</b>					2007	L4 2.4L		86	525
<b>VehiCROSS</b>					<b>Cherokee</b>					<b>TJ</b>				
2001-99	V6 3.5L Optional		27	625	2014	L4 2.4L	47,54	48	600	2006-05	L4 2.4L		34	600
2001	V6 3.5L		24	585	2014	V6 3.2L		94R	730	2006-02	L6 4.0L		34	600
2000-99	V6 3.5L		24	580	2001-98	L6 4.0L		34	500	2003	L4 2.4L		34	600
<b>JAGUAR</b>					<b>Cherokee</b>					<b>Wrangler</b>				
<b>S-Type</b>					<b>Commander</b>					<b>Wrangler</b>				
2008-07	V6 3.0L	54	49	950	2010	V6 3.7L		94R	625	2014	V6 3.6L	47,54	48	600
2008	V8 4.2L	54	49	850	2010	V8 5.7L		94R	625	2013-12	V6 3.6L		48	600
2007	V8 4.2L	54	49	950	2010	V8 5.7L		94R	625	2011-10	V6 3.8L	71	34	600
2006-03	V6 3.0L	54	49	750	2009	V6 3.7L	71	94R	730	2009-08	V6 3.8L		34	600
2006-03	V8 4.2L	54	49	750	2009	V8 4.7L	71	94R	730	2007	V6 3.8L		34	600
2002-00	V6 3.0L	54	49	680	2009	V8 5.7L	71	94R	730	2006-03	L4 2.4L		34	600
2002-00	V8 4.0L	54	49	680	2008	V6 3.7L Early	71	94R	730	2006-02	L6 4.0L		34	600
<b>Super V8</b>					<b>Compass</b>					<b>Wrangler</b>				
2009-07	V8 4.2L	54	93	800	2008	V6 3.7L Late	71	94R	625	2014	V6 3.6L	47,54	48	600
2006-05	V8 4.2L		93	680	2008	V8 4.7L Early	71	94R	730	2013-12	V6 3.6L		48	600
<b>Vanden Plas</b>					<b>Grand Cherokee</b>					<b>Wrangler</b>				
2009	V8 4.2L	54	93	680	2010	V6 3.7L		94R	625	2011-10	V6 3.8L	71	34	600
2008-04	V8 4.2L		93	680	2010	V8 5.7L		94R	625	2009-08	V6 3.8L		34	600
2003-98	V8 4.0L		49	680	2008	V8 4.7L Late	71	94R	625	2007	V6 3.8L		34	600
1997	L6 4.0L		93	680	2008	V8 5.7L Early	71	94R	730	2006-03	L4 2.4L		34	600
1996-95	L6 4.0L	6,54	47	590	2008	V8 5.7L Late	71	94R	625	2006-02	L6 4.0L		34	600
<b>XF</b>					<b>Compass</b>					<b>Wrangler</b>				
2013-10	V8 5.0L	54	49	800	2007-06	V6 3.7L		94R	730	2002	L4 2.5L		34	600
2010-09	V8 4.2L	54	49	800	2007-06	V8 4.7L		94R	730	2001-97	L4 2.5L		34	500
<b>XFR</b>					<b>Compass</b>					<b>Wrangler</b>				
2013-10	V8 5.0L	54	49	800	2014-07	L4 2.0L		86	525	2001-97	L6 4.0L		34	500
<b>XJ</b>					<b>Compass</b>					<b>Wrangler</b>				
2013-11	V8 5.0L	54	49	800	2014-07	L4 2.4L		86	525	2000-97	L4 2.5L Optional		34	600
2013	V6 3.0L	54	49	800	<b>Grand Cherokee</b>					2000	L6 4.0L Optional		34	600
<b>XJ12</b>					<b>Grand Cherokee</b>					<b>Wrangler</b>				
1996-95	V12 6.0L	6,54	47	590	2014	V6 3.0L Diesel	47,54	49	800	1998-97	L6 4.0L Optional		34	600
<b>XJ6</b>					<b>Grand Cherokee</b>					<b>Wrangler</b>				
1997-95	L6 4.0L	6,54	47	590	2014	V6 3.6L	47,54	49	800	1995	L4 2.5L		58	430
<b>XJ8</b>					<b>Grand Cherokee</b>					<b>Wrangler</b>				
2009-07	V8 4.2L	54	49	950	2014	V8 5.7L	47,54	94R	730	1995	L4 2.5L Optional		58	500
2006-04	V8 4.2L	54	49	750	2014	V8 6.4L	47,54	94R	730	1995	L6 4.0L		58	430
2003-98	V8 4.0L		49	680	2013-12	V8 6.4L	47,54	94R	700	1995	L6 4.0L Optional		58	500
<b>XJR</b>					<b>Compass</b>					<b>KIA</b>				
2009-07	V8 4.2L	54	49	950	2013-11	V6 3.6L	47,54	94R	700	<b>Amanti</b>				
2006-04	V8 4.2L	54	49	750	2013-11	V8 5.7L	47,54	94R	700	2009-07	V6 3.8L		124R	600
<b>XJR</b>					<b>Compass</b>					<b>Amanti</b>				
2009-07	V8 4.2L	54	49	950	2010	V6 3.7L		94R	625	2006-05	V6 3.5L		124R	600
2006-04	V8 4.2L	54	49	750	2010	V8 5.7L		94R	625	2004	V6 3.5L		34R	600
<b>XJR</b>					<b>Compass</b>					<b>Borrego</b>				
2009-07	V8 4.2L	54	49	950	2010	V8 6.1L		94R	625	2011-09	V6 3.8L		124R	600
2006-04	V8 4.2L	54	49	750	2009-08	V6 3.0L Diesel	71	94R	800	2011-09	V8 4.6L	45	N/A	900
2003-98	V8 4.0L		49	680	2009	V6 3.7L	71	94R	730	<b>Cadenza</b>				
<b>XJR</b>					<b>Compass</b>					<b>Cadenza</b>				
2009-07	V8 4.2L	54	49	950	2009	V8 4.7L	71	94R	730	2014	V6 3.3L		124R	660
2006-04	V8 4.2L	54	49	750	2009	V8 5.7L	71	94R	730	<b>Forte</b>				
2003-98	V8 4.0L		49	680	2009	V8 6.1L	71	94R	730	2014	L4 1.6L		47	550
<b>XJR</b>					<b>Compass</b>					<b>Forte</b>				
2009-07	V8 4.2L	54	49	950	2008	V6 3.7L Early	71	94R	730	2014	L4 1.8L		47	550
2006-04	V8 4.2L	54	49	750	2008	V6 3.7L Late	71	94R	625	2014	L4 2.0L		47	550
<b>XJR</b>					<b>Compass</b>					<b>Forte</b>				
2009-07	V8 4.2L	54	49	950	2008	V8 4.7L Early	71	94R	730	2013-10	L4 2.0L		121R	550
2006-04	V8 4.2L	54	49	750	2008	V8 4.7L Late	71	94R	625	2013-10	L4 2.4L		121R	550
<b>XJR</b>					<b>Compass</b>					<b>Forte Koup</b>				
2009-07	V8 4.2L	54	49	950	2008	V8 4.7L Late	71	94R	625	2014-10	L4 2.0L		121R	550
2006-04	V8 4.2L	54	49	750	<b>Grand Cherokee</b>					2014	L4 1.6L		121R	550
<b>XJR</b>					<b>Grand Cherokee</b>					<b>Forte Koup</b>				
2009-07	V8 4.2L	54	49	950	2014	V6 3.0L Diesel	47,54	49	800	2013-10	L4 2.4L		121R	550
2006-04	V8 4.2L	54	49	750	2014	V6 3.6L	47,54	49	800	<b>Grand Cherokee</b>				
<b>XJR</b>					<b>Grand Cherokee</b>					<b>Grand Cherokee</b>				
2009-07	V8 4.2L	54	49	950	2014	V8 5.7L	47,54	94R	730	2008	V8 5.7L Early	71	94R	730
2006-04	V8 4.2L	54	49	750	2014	V8 6.4L	47,54	94R	730	2008	V8 5.7L Late	71	94R	625
<b>XJR</b>					<b>Grand Cherokee</b>					<b>Grand Cherokee</b>				
2009-07	V8 4.2L	54	49	950	2013-12	V8 6.4L	47,54	94R	700	2008	V8 4.7L Early	71	94R	730
2006-04	V8 4.2L	54	49	750	2013-11	V6 3.6L	47,54	94R	700	2008	V			

# Passenger Car & Light Truck

YEAR	ENGINE/ OPTIONS	FOOT NOTE	GROUP/ TYPE NO.	O.E. CCA (@0°F)	YEAR	ENGINE/ OPTIONS	FOOT NOTE	GROUP/ TYPE NO.	O.E. CCA (@0°F)	YEAR	ENGINE/ OPTIONS	FOOT NOTE	GROUP/ TYPE NO.	O.E. CCA (@0°F)
<b>KIA (Cont.)</b>					<b>LAMBORGHINI (Cont.)</b>					<b>LEXUS (Cont.)</b>				
<b>Forte5</b>					<b>Gallardo</b>					<b>GS400</b>				
2013-12	L4 2.0L		121R	550	2012-09	V10 5.2L	54	49	800	2000-98	V8 4.0L		24	585
2013-12	L4 2.4L		121R	550	2009-08	V10 5.0L	54	49	800	<b>GS430</b>				
<b>Magentis</b>					<b>Murcielago</b>					<b>GS450h</b>				
2010-02	V6 2.7L		124R	600	2007-04	V10 5.0L	54	34	700	2007-01	V8 4.3L		24	585
2010-01	L4 2.4L		124R	600	<b>LAND ROVER</b>					<b>GS460</b>				
2001	V6 2.5L		124R	600	2010-08	V12 6.5L	54	49	800	2014-13	V6 3.5L Hybrid	45,54,60,69	S65D26L	360
<b>Optima</b>					<b>LAND ROVER</b>					<b>GS460</b>				
2014-11	L4 2.0L		124R	600	<b>Defender 90</b>					<b>GS460</b>				
2014-11	L4 2.4L Hybrid	45,52	H6R	600	1997	V8 4.0L	9	24	600	2011-08	V8 4.6L		24	585
2014	L4 2.4L Gas	69	48	760	1995	V8 3.9L	9	24	600	<b>GX460</b>				
2013-11	L4 2.4L Gas		124R	600	<b>Discovery</b>					<b>GX470</b>				
2010-04	L4 2.4L		124R	600	2004	V8 4.6L		34	700	2014-10	V8 4.6L		24F	585
2010-02	V6 2.7L		124R	600	2003	V8 4.6L	9	24	590	<b>GX470</b>				
2003-01	L4 2.4L	6	47	600	2002-99	V8 4.0L	9	24	600	2009-03	V8 4.7L		27F	710
2002-01	V6 2.5L	6	47	600	1998-96	V8 4.0L		34	600	<b>HS250h</b>				
<b>Rio</b>					<b>LR2</b>					<b>IS F</b>				
2014-13	L4 1.6L w/ISG	69	48	760	2014-13	L4 2.0L		94R	720	2012-10	L4 2.4L Hybrid	45,54,60,67,69	S55D23R	360
2014-13	L4 1.6L w/o ISG		121R	550	2012-08	L6 3.2L		94R	720	<b>IS F</b>				
2012	L4 1.6L		121R	550	<b>Freelander</b>					<b>IS250</b>				
2011-03	L4 1.6L		35	500	2005-02	V6 2.5L		48	680	2014-06	V6 2.5L		24	585
2002-01	L4 1.5L		35	500	<b>LR3</b>					<b>IS300</b>				
<b>Rio5</b>					<b>LR3</b>					<b>IS300</b>				
2012	L4 1.6L		121R	550	2014-13	L4 2.0L		94R	720	2005-01	L6 3.0L		24	585
2011-06	L4 1.6L		35	500	2012-08	L6 3.2L		94R	720	<b>IS350</b>				
<b>Rondo</b>					<b>LR4</b>					<b>IS350</b>				
2014	L4 2.0L		124R	600	2009-05	V8 4.4L		94R	700	2014-06	V6 3.5L		24	585
2012-07	L4 2.4L		124R	600	2008-07	V6 4.0L		94R	700	<b>LFA</b>				
2012-07	V6 2.7L		124R	600	2006-05	V6 4.0L	6	49	720	2012	V10 4.8L	45,54,60,67,69	S75D31R	450
<b>Sedona</b>					<b>LR4</b>					<b>LS400</b>				
2014	V6 3.5L		124R	660	2014	V6 3.0L		94R	720	2000-95	V8 4.0L		24F	585
2012-11	V6 3.5L		124R	660	2013-10	V8 5.0L		94R	720	<b>LS430</b>				
2010-06	V6 3.8L		124R	600	<b>Range Rover</b>					<b>LS430</b>				
2005-03	V6 3.5L		24F	500	2014-10	V8 5.0L		49	720	2006-01	V8 4.3L		24F	585
2002	V6 3.5L		24F	600	2014	V6 3.0L		49	720	<b>LS460</b>				
<b>Sephia</b>					<b>Range Rover</b>					<b>LS460</b>				
2001-95	L4 1.8L	22	90	450	2009-07	V8 4.2L		49	800	2014-07	V8 4.6L		24	585
1997-95	L4 1.6L	23	56	450	2009-07	V8 4.4L		49	800	<b>LS600h</b>				
<b>Sorento</b>					<b>Range Rover</b>					<b>LS600h</b>				
2014-11	L4 2.4L		124R	700	2006-03	V8 4.4L		95R	850	2014-08	V8 5.0L Hybrid	45,54,60,69	S75D31L	450
2014	V6 3.3L		124R	660	2006	V8 4.2L		95R	850	<b>LX450</b>				
2013-11	V6 3.5L		124R	700	2002-99	V8 4.6L		30H	900	1997-96	L6 4.5L		27F	625
2009-08	V6 3.3L		124	600	2000-99	V8 4.0L		30H	900	<b>LX470</b>				
2009-07	V6 3.8L		124	600	1998-96	V8 4.6L		31A	660	2007-03	V8 4.7L		27F	710
2006-03	V6 3.5L		124	600	1998-95	V8 4.0L		30H	825	2002	V8 4.7L		27F	585
<b>Soul</b>					<b>Range Rover Evoque</b>					<b>LX570</b>				
2014-13	L4 1.6L w/ISG	69	48	760	2014	L4 2.0L	47,54,66	94R	800	2014-13	V8 5.7L		27F	710
2014-13	L4 1.6L w/o ISG		121R	550	2013-12	L4 2.0L	54,66	94R	770	2011-08	V8 5.7L		27F	710
2014-13	L4 2.0L w/ISG	69	48	760	<b>Range Rover Sport</b>					<b>RX300</b>				
2014-13	L4 2.0L w/o ISG		121R	550	2014-10	V8 5.0L		94R	720	2003-99	V6 3.0L		24F	585
2012-10	L4 1.6L		121R	550	2014	V6 3.0L		94R	720	<b>RX330</b>				
2012-10	L4 2.0L		121R	550	2009-06	V8 4.2L		49	720	2006-04	V6 3.3L		24F	585
<b>Spectra</b>					<b>LEXUS</b>					<b>RX350</b>				
2009-04	L4 2.0L	6	121R	540	<b>CT200h</b>					<b>RX350</b>				
2004	L4 1.8L	6	121R	540	<b>ES300</b>					<b>RX350</b>				
2003-00	L4 1.8L	6	90	450	2014-11	L4 1.8L Hybrid	45,54,67,69	S46B24R	325	2014-10	V6 3.5L	67	24F	585
<b>Spectra5</b>					<b>ES300</b>					<b>RX400h</b>				
2009-05	L4 2.0L	6	121R	540	2003-99	V6 3.0L		35	360	2008-06	V6 3.3L Hybrid		51R	435
<b>Sportage</b>					<b>ES300h</b>					<b>RX450h</b>				
2014-11	L4 2.4L		124R	600	2003-95	V6 3.0L Optional		24F	585	2014-10	V6 3.5L Hybrid	45,54,60,67,69	S55D23L	360
2014-05	L4 2.0L		124R	600	1997-95	V6 3.0L		35	360	<b>SC300</b>				
2010-05	V6 2.7L		124R	600	<b>ES300h</b>					<b>SC300</b>				
2002	L4 2.0L	29,45	N/A	600	2014-13	L4 2.5L Hybrid	45,54,60,69	S65D26R	450	2000-97	L6 3.0L		24F	585
2001-00	L4 2.0L From 5/16/00	7	86	540	<b>ES330</b>					1996-95	L6 3.0L		27F	450
2000	L4 2.0L To 5/16/00	7	58	470	2006-04	V6 3.3L		24F	585	<b>SC400</b>				
1999-95	L4 2.0L	7	58	470	<b>ES350</b>					2000-95	V8 4.0L		27F	625
<b>LAMBORGHINI</b>					<b>ES350</b>					<b>SC430</b>				
<b>Aventador</b>					<b>GS300</b>					<b>SC430</b>				
2012	V12 6.5L	54	49	800	2014-07	V6 3.5L		24F	585	2010-03	V8 4.3L		48	585
<b>Diablo</b>					<b>GS350</b>					<b>LINCOLN</b>				
2001-00	V12 6.0L	54	34R	700	2006	V6 3.0L		24	585	<b>Aviator</b>				
2000-95	V12 5.7L	54	34R	700	2005-98	L6 3.0L		24	585	2005-03	V8 4.6L		65	650
<b>LAMBORGHINI</b>					<b>GS350</b>					<b>Blackwood</b>				
<b>Aventador</b>					<b>GS350</b>					<b>Blackwood</b>				
2012	V12 6.5L	54	49	800	2014-13	V6 3.5L		24	585	2002	V8 5.4L		65	650
<b>Diablo</b>					<b>GS350</b>					<b>Blackwood</b>				
2001-00	V12 6.0L	54	34R	700	2011-07	V6 3.5L		24	585	<b>Blackwood</b>				
2000-95	V12 5.7L	54	34R	700	<b>GS350</b>					<b>Blackwood</b>				

# Passenger Car & Light Truck

YEAR	ENGINE/ OPTIONS	FOOT NOTE	GROUP/ TYPE NO.	O.E. CCA (@0°F)	YEAR	ENGINE/ OPTIONS	FOOT NOTE	GROUP/ TYPE NO.	O.E. CCA (@0°F)	YEAR	ENGINE/ OPTIONS	FOOT NOTE	GROUP/ TYPE NO.	O.E. CCA (@0°F)
<b>LINCOLN (Cont.)</b>					<b>MASERATI (Cont.)</b>					<b>MAZDA (Cont.)</b>				
<b>Continental</b>					<b>GranTurismo</b>					<b>6 (Cont.)</b>				
2002-97	V8 4.6L		65	750	2013-09	V8 4.7L	54,66	48	600	2007-06	L4 2.3L ex. Mazdaspeed		40R	585
1996-95	V8 4.6L		65	850	2011-08	V8 4.2L	54,66	48	600	2007-06	L4 2.3L Mazdaspeed		35	550
<b>LS</b>					<b>Quattroporte</b>					2007 V6 3.0L 40R 585				
2006-00	V8 3.9L	54	66	650	2013-09	V8 4.7L	54,66	49	850	2006-03	V6 3.0L		40R	590
2005-01	V6 3.0L Optional	54	66	750	2011-08	V8 4.2L	54,66	48	600	2005-03	L4 2.3L		40R	590
2005-01	V8 3.9L Optional	54	66	750	2007-04	V8 4.2L	54,66	48	785	<b>626</b>				
2005-00	V6 3.0L	54	66	650	<b>Spyder</b>					2002-98 L4 2.0L 36R 580				
<b>Mark LT</b>					2006-02 V8 4.2L 54,66 48 785					2002-98 V6 2.5L 36R 580				
2008-06	V8 5.4L		59	540	<b>MAYBACH</b>					1997-95 L4 2.0L 58R 580				
2008-06	V8 5.4L Optional		65	650	<b>57</b>					1997-95 V6 2.5L 58R 580				
<b>Mark VIII</b>					2012-06 V12 6.0L 47,54,66 49 850					<b>929</b>				
1998-97	V8 4.6L Optional		65	750	2012-06	V12 6.0L Optional	47,54,66	49	950	1995 V6 3.0L Canada & Optional 24F 585				
1998-95	V8 4.6L U.S.		65	650	2012-03	V12 5.5L	47,54,66	49	850	1995 V6 3.0L Serenia, U.S. 35 350				
1996-95	V8 4.6L Canada & Optional		65	850	2012-03	V12 5.5L Optional	47,54,66	49	950	<b>B2300</b>				
<b>MKS</b>					<b>62</b>					2010-01 L4 2.3L 59 540				
2014-10	V6 3.5L		65	650	2012-07	V12 6.0L	47,54,66	49	850	1997-95	L4 2.3L Optional		65	540
2014-09	V6 3.7L		65	650	2012-07	V12 6.0L Optional	47,54,66	49	950	1997	L4 2.3L		59	540
<b>MKT</b>					<b>MAZDA</b>					1996-95 L4 2.3L 58 540				
2014-13	L4 2.0L		65	650	<b>2</b>					<b>B2500</b>				
2014-13	V6 3.5L		65	750	2014-11	L4 1.5L		21R	350	2001-98 L4 2.5L 59 540				
2014-13	V6 3.7L		65	750	2014-11	L4 1.5L Canada & Cold Climate		35	525	<b>B3000</b>				
2012-10	V6 3.5L		65	650	<b>3</b>					2008-98 V6 3.0L 59 540				
2012-10	V6 3.5L Optional		65	750	2014-12	L4 2.0L SKYACTIV		35	525	1997-95 V6 3.0L 58 540				
2012-10	V6 3.7L		65	650	2014-11	L4 2.0L		21R	350	<b>B4000</b>				
2012-10	V6 3.7L Optional		65	750	2014-11	L4 2.0L Canada & Cold Climate		35	525	2010-98 V6 4.0L 59 540				
<b>MKX</b>					2014-11 L4 2.5L 21R 350					1997-95 V6 4.0L 65 650				
2014-11	V6 3.7L		65	650	2014-11	L4 2.5L Canada & Cold Climate		35	525	<b>CX-5</b>				
2010-07	V6 3.5L		36R	650	2014-11	L4 2.5L		21R	350	2014-13 L4 2.0L 45 55D23L 0				
<b>MKZ</b>					2014-11 L4 2.5L 21R 350					2014 L4 2.5L 45 55D23L 0				
2014-13	L4 2.0L Gas		90	590	2014-11	L4 2.5L Canada & Cold Climate		35	525	<b>CX-7</b>				
2014-13	L4 2.0L Hybrid	54	67R	390	2013-11	L4 2.3L		35	525	2012-11 L4 2.3L Canada 24F 585				
2014-13	V6 3.7L		90	590	2010-08	L4 2.0L AT		35	355	2012-11 L4 2.3L U.S. 35 525				
2012-11	L4 2.5L Hybrid		67R	390	2010-08	L4 2.0L MT		26R	310	2012-10 L4 2.5L 35 550				
2012-10	V6 3.5L		96R	500	2010-08	L4 2.3L AT		35	355	2010 L4 2.3L 35 550				
2009-07	V6 3.5L		96R	590	2010-08	L4 2.3L MT		26R	310	2009-07 L4 2.3L 35 360				
<b>Navigator</b>					2010 L4 2.5L AT 35 355					<b>CX-9</b>				
2014	V8 5.4L		65	750	2010	L4 2.5L MT		26R	310	2014-08 V6 3.7L 24F 585				
2013-07	V8 5.4L ex. Climate Seats		65	650	2010	L4 2.5L AT		35	355	2007 V6 3.5L 24F 585				
2013-07	V8 5.4L w/Climate seats		65	750	2007	L4 2.0L		35	355	<b>Miata</b>				
2006-98	V8 5.4L		65	650	2007	L4 2.0L Cold Climate		35	490	2005-99 L4 1.8L 45,47,54 46A24L 320				
2006-98	V8 5.4L Optional		65	750	2007	L4 2.3L Cold Climate		35	490	1997-95 L4 1.8L 45,47,54 46A24L 320				
<b>Town Car</b>					2006-04 L4 2.3L 35 550					<b>Millenia</b>				
2011-06	V8 4.6L Long Wheel Base		65	750	2006	L4 2.0L		35	550	2002-95 V6 2.3L Optional 24F 585				
2011-06	V8 4.6L Short Wheel Base		65	650	2005-04	L4 2.0L Optional		35	520	2002-01 V6 2.3L 35 520				
2005-99	V8 4.6L Optional & Limo		65	750	2005	L4 2.0L		21R	350	2002-01 V6 2.5L Optional 24F 490				
2005-97	V8 4.6L ex. Limousine		65	650	2004	L4 2.0L		21R	310	2002 V6 2.5L 35 520				
1998-97	V8 4.6L Optional & Limo		65	850	<b>3 Sport</b>					2001 V6 2.5L 35 360				
1996-95	V8 4.6L ex. HWS or Limo		65	650	2014-12	L4 2.0L		21R	350	2000-95 V6 2.3L 35 490				
1996-95	V8 4.6L HWS or Opt., Limo		65	850	2014-12	L4 2.0L Canada & Cold Climate		35	525	2000-95 V6 2.5L 35 350				
<b>Zephyr</b>					2014-12 L4 2.0L SKYACTIV 35 525					<b>MPV</b>				
2006	V6 3.0L		40R	590	2014-12	L4 2.5L		21R	350	2006-02 V6 3.0L 35 360				
<b>LOTUS</b>					2014-12 L4 2.5L Canada & Cold Climate 35 525					2006-02 V6 3.0L Optional 24F 490				
<b>Elise</b>					2014-12 L4 2.5L AT 35 550					2001-00 V6 2.5L 35 360				
2009-08	L4 1.8L	54	47	520	2010	L4 2.3L AT		35	550	2001-00 V6 2.5L Optional 24F 490				
2007-05	L4 1.8L		26R	550	2010	L4 2.3L MT		26R	540	1998-96 V6 3.0L Canada & Optional 24F 490				
<b>Exige</b>					2009 L4 2.3L AT 35 355					1998-96 V6 3.0L U.S. 35 350				
2009-08	L4 1.8L	54	48	600	2009	L4 2.3L MT		26R	310	1995 V6 3.0L 2WD 21R 310				
2007-06	L4 1.8L		26R	550	2008-06	L4 2.3L		35	550	1995 V6 3.0L 4WD 24F 490				
<b>MASERATI</b>					2008-06 L4 2.3L 35 550					1995 V6 3.0L Optional 24F 585				
<b>Coupe</b>					<b>6</b>					<b>MX-3</b>				
2007-03	V8 4.2L	54,66	48	785	2014	L4 2.5L	45	N/A	0	1996-95 L4 1.6L 21R 310				
<b>GranSport</b>					2013-09 L4 2.5L 96R 590					1995 L4 1.6L Optional 35 350				
2007-05	V8 4.2L	54,66	48	785	2013-09	V6 3.7L		96R	590	1995 V6 1.8L 35 350				
<b>2008 L4 2.3L 40R 590</b>					2008 V6 3.0L 40R 590					<b>MX-5 Miata</b>				
<b>2008 V6 3.0L 40R 590</b>					2014-06 L4 2.0L 51R 410					<b>MX-6</b>				
<b>2008 V6 3.0L 40R 590</b>					1997-95 L4 2.0L 58R 580					1997-95 V6 2.5L 58R 580				

# Passenger Car & Light Truck

YEAR	ENGINE/ OPTIONS	FOOT NOTE	GROUP/ TYPE NO.	O.E. CCA (@0°F)	YEAR	ENGINE/ OPTIONS	FOOT NOTE	GROUP/ TYPE NO.	O.E. CCA (@0°F)	YEAR	ENGINE/ OPTIONS	FOOT NOTE	GROUP/ TYPE NO.	O.E. CCA (@0°F)
<b>MAZDA (Cont.)</b>					<b>MERCEDES-BENZ (Cont.)</b>					<b>MERCEDES-BENZ (Cont.)</b>				
<b>Protege</b>					<b>C43 AMG</b>					<b>E280</b>				
2003-01	L4 1.6L		21R	310	2000-98	V8 4.3L	54	49	825	2007	V6 3.0L	54,66	49	850
2003-01	L4 1.6L Optional		35	520	<b>C55 AMG</b>					<b>E300</b>				
2003-01	L4 2.0L		21R	310	2006	V8 5.5L	54	49	760	2013-12	V6 3.5L	54,66	49	850
2003-01	L4 2.0L Optional		35	520	2005	V8 5.5L	54	49	825	2009-08	V6 3.0L	54,66	49	850
2000-99	L4 1.6L Optional		35	350	<b>C63 AMG</b>					1999-95	L6 3.0L Diesel	54	49	825
2000-99	L4 1.8L		35	350	2014-08	V8 6.3L	47,54,66	49	850	<b>E320</b>				
1999	L4 1.6L		21R	310	<b>CL500</b>					2009	V6 3.0L Diesel	54	49	760
1998-95	L4 1.5L		21R	310	2006	V8 5.0L	47	49	850	2008-07	V6 3.0L Diesel	54	49	850
1998-95	L4 1.5L Optional		35	350	2005-98	V8 5.0L	54	49	825	2006	L6 3.2L Diesel	47,54	49	850
1998-95	L4 1.8L		21R	310	<b>CL55 AMG</b>					2005-02	V6 3.2L	54	49	825
<b>Protege5</b>					2006	V8 5.5L	47	49	850	2005	L6 3.2L	54	49	825
2003-02	L4 2.0L		21R	310	2005-04	V8 5.5L	54	49	825	2001	V6 3.2L Sedan	54	49	825
2003-02	L4 2.0L Optional		35	520	2003	V8 5.5L	54	49	850	2001	V6 3.2L Wagon	54	49	825
<b>RX-7</b>					2002-01	V8 5.5L	54	49	825	2000-99	V6 3.2L	54	49	825
1995	R2 1.3L AT & Canada		24F	490	<b>CL550</b>					1998	V6 3.2L		48	690
1995	R2 1.3L MT		35	420	2014-11	V8 4.6L On-Board Electrical System Battery	47,54,66	49	850	1997-96	L6 3.2L		48	690
<b>RX-8</b>					2014-11	V8 4.6L Starting Motor Battery	45,52,66	V4	520	1995	L6 3.2L		48	660
2011	R2 1.3L Canada		35	525	2010-07	V8 5.5L On-Board Electrical System Battery	47,54,66	49	850	<b>E350</b>				
2011	R2 1.3L U.S.		24F	585	2010-07	V8 5.5L On-Board Electrical System Battery	47,54,66	49	850	2014-10	V6 3.5L	47,54,66	48	760
2010	R2 1.3L		35	550	2010-07	V8 5.5L Starting Motor Battery	45,52,66	V4	520	2013-11	V6 3.0L Diesel	47,54,66	48	760
2009-04	R2 1.3L	9	35	640	2010-07	V8 5.5L Optional, On-Board Electrical System Battery	47,54,66	48	760	2009-06	V6 3.5L	47,54,66	49	850
<b>Tribute</b>					<b>CL600</b>					<b>E420</b>				
2011	L4 2.5L		96R	590	2014-08	V12 5.5L On-Board Electrical System Battery	47,54,66	49	850	1997	V8 4.2L		48	690
2011	V6 3.0L		96R	590	2014-08	V12 5.5L Starting Motor Battery	45,52,66	V4	520	1995	V8 4.2L	54	49	825
2010-09	L4 2.5L Hybrid		96R	500	2007-03	V12 5.5L	47,54,66	49	850	<b>E430</b>				
2010	L4 2.5L Gas		40R	650	2002-01	V12 5.8L	54	49	825	2002	V8 4.3L	54	49	825
2010	V6 3.0L		40R	650	1999-98	V12 6.0L	54,66	49	760	2001	V8 4.3L Sedan	54	49	825
2009-08	V6 3.0L		40R	590	<b>CL63 AMG</b>					2001	V8 4.3L Wagon	54	49	825
2009	L4 2.5L Gas		40R	590	2014-11	V8 5.5L	47,54,66	49	850	2000-98	V8 4.3L	54	49	825
2008	L4 2.3L Gas		40R	590	2010-08	V8 6.3L	47,54,66	49	850	<b>E500</b>				
2008	L4 2.3L Hybrid		96R	500	<b>CL65 AMG</b>					2006	V8 5.0L	47,54	49	850
2006-05	L4 2.3L		40R	590	2014-08	V12 6.0L On-Board Electrical System Battery	47,54,66	49	850	2005-03	V8 5.0L	54	49	825
2006-01	V6 3.0L		40R	590	2014-08	V12 6.0L Starting Motor Battery	45,52,66	V4	520	<b>E55 AMG</b>				
2004-01	L4 2.0L		96R	500	2006-05	V12 6.0L	47,54,66	49	850	2006	V8 5.5L	47,54	49	850
<b>MERCEDES-BENZ</b>					<b>CL63 AMG</b>					<b>E550</b>				
<b>B200</b>					2014-11	V8 5.5L	47,54,66	49	850	2005-04	V8 5.5L	54	49	825
2011-06	L4 2.0L	54,66	48	680	2010-08	V8 6.3L	47,54,66	49	850	2003	V8 5.5L	54	49	850
<b>C220</b>					<b>CL65 AMG</b>					2002-99	V8 5.5L	54	49	825
1996-95	L4 2.2L	54	49	825	2014-08	V12 6.0L On-Board Electrical System Battery	47,54,66	49	850	<b>E550</b>				
<b>C230</b>					2014-08	V12 6.0L Starting Motor Battery	45,52,66	V4	520	2014-12	V8 4.6L	54,66	49	850
2009-08	V6 2.5L	54,66	49	760	2006-05	V12 6.0L	47,54,66	49	850	2011-07	V8 5.5L	54,66	49	850
2007-06	V6 2.5L	54	49	760	<b>CLK320</b>					<b>E63 AMG</b>				
2005-03	L4 1.8L	54	49	825	2005-98	V6 3.2L	54	49	825	2014-12	V8 5.5L	47,54,66	48	760
2002	L4 2.3L	54	49	825	<b>CLK350</b>					2011-10	V8 6.3L	47,54,66	48	760
2000-97	L4 2.3L	54	49	825	2009-06	V6 3.5L	54	49	760	2009-07	V8 6.3L	47,54,66	49	850
<b>C240</b>					<b>CLK430</b>					<b>G500</b>				
2005-04	V6 2.6L	54	49	825	2003-99	V8 4.3L	54	49	825	2008-07	V8 5.0L	54	49	850
2003	V6 2.6L	54	49	850	<b>CLK500</b>					2006-02	V8 5.0L	54	49	825
2002-01	V6 2.6L	54	49	825	2006	V8 5.0L	54	49	760	<b>G55 AMG</b>				
<b>C250</b>					2005-03	V8 5.0L	54	49	825	2011-07	V8 5.5L	54,66	49	850
2014-12	L4 1.8L	47,66	48	760	<b>CLK55 AMG</b>					2006-03	V8 5.5L	54	49	825
2012-10	V6 2.5L	66	94R	700	2006	V8 5.5L	54	49	760	2003	V8 5.5L Optional	47,54	49	850
2012-10	V6 2.5L Optional	47,66	48	760	2005-01	V8 5.5L	54	49	825	<b>G550</b>				
<b>C280</b>					2009-07	V8 5.5L	54	49	760	2014-09	V8 5.5L	47,54,66	49	850
2007-06	V6 3.0L	54	49	760	<b>CLK63 AMG</b>					<b>G63 AMG</b>				
2000-98	V6 2.8L	54	49	825	2009-07	V8 6.3L	54	49	760	2014-13	V8 5.5L	47,54,66	49	850
1997-95	L6 2.8L	54	49	825	2008	V8 6.3L Optional	47	48	760	2009-07	V6 3.0L Diesel	54,66	49	850
<b>C300</b>					<b>CLS500</b>					<b>GL320</b>				
2014-13	V6 3.5L	54,66	94R	700	2006	V8 5.0L	47	49	850	2014-10	V6 3.0L Diesel	47,54,66	49	850
2012-08	V6 3.0L	54,66	94R	700	<b>CLS55 AMG</b>					<b>GL350</b>				
<b>C32 AMG</b>					2006	V8 5.5L	54	49	760	2014-10	V6 3.0L Diesel	47,54,66	49	850
2004-03	V6 3.2L	54	49	825	2006	V8 5.5L	54	49	825	<b>GL450</b>				
2002	V6 3.2L	54	49	850	<b>CLS550</b>					<b>GL550</b>				
<b>C320</b>					2014-12	V8 4.6L	47,54,66	49	850	2014-13	V8 4.6L	47,54,66	49	850
2005-04	V6 3.2L	54	49	825	2011-07	V8 5.5L	47,54,66	49	850	2012-08	V8 5.5L	47,54,66	49	850
2003	V6 3.2L	54	49	850	<b>CLS63 AMG</b>					<b>GL63 AMG</b>				
2002-01	V6 3.2L	54	49	825	2014-12	V8 5.5L	47,54,66	49	850	2014-13	V8 5.5L	47,54,66	49	850
<b>C350</b>					2011-07	V8 6.3L	47,54,66	49	850	<b>GLK350</b>				
2014-08	V6 3.5L	54,66	94R	700	<b>CLS63 AMG</b>					<b>ML320</b>				
2007-06	V6 3.5L	54,66	49	760	2014-12	V8 5.5L	47,54,66	49	850	2009	V6 3.0L Diesel	54	49	760
<b>C36 AMG</b>					2011-07	V8 6.3L	47,54,66	49	850	2008-07	V6 3.0L Diesel	54	49	850
1997-95	L6 3.6L	54	49	825						2003-98	V6 3.2L		49	825

# Passenger Car & Light Truck

YEAR	ENGINE/ OPTIONS	FOOT NOTE	GROUP/ TYPE NO.	O.E. CCA (@0°F)	YEAR	ENGINE/ OPTIONS	FOOT NOTE	GROUP/ TYPE NO.	O.E. CCA (@0°F)	YEAR	ENGINE/ OPTIONS	FOOT NOTE	GROUP/ TYPE NO.	O.E. CCA (@0°F)
<b>MERCEDES-BENZ (Cont.)</b>					<b>MERCEDES-BENZ (Cont.)</b>					<b>MERCEDES-BENZ (Cont.)</b>				
<b>ML350</b>					<b>S600</b>					<b>SLK280</b>				
2014-10	V6 3.0L Diesel	47,54,66	49	850	2013-08	V12 5.5L On-Board Electrical System Battery	47,54,66	49	850	2008-07	V6 3.0L	54,66	48	680
2014-08	V6 3.5L	47,54,66	49	850						2006	V6 3.0L	47,54	98R	760
2007-06	V6 3.5L	47,54,66	49	950	2013-08	V12 5.5L Starting Motor Battery	45,52,66	V4	520	<b>SLK300</b>				
2005-04	V6 3.7L	54,66	49	760	2007-03	V12 5.5L	47,54,66	49	850	2011-09	V6 3.0L	54,66	48	680
2003	V6 3.7L		49	825	2002-01	V12 5.8L	54	49	825	<b>SLK32 AMG</b>				
<b>ML430</b>					1999-95	V12 6.0L	47,54	49	825	2004-03	V6 3.2L	54	48	690
2001-99	V8 4.3L		49	825	<b>S63 AMG</b>					2002	V6 3.2L		48	690
<b>ML450</b>					2014-11	V8 5.5L	47,54,66	49	850	<b>SLK320</b>				
2011-10	V6 3.5L Hybrid	54,66	49	850	2010-08	V8 6.3L	47,54,66	49	850	2004-02	V6 3.2L	54	48	690
<b>ML500</b>					<b>S65 AMG</b>					2001	V6 3.2L	54	49	825
2007	V8 5.0L	54	49	950	2013-08	V12 6.0L On-Board Electrical System Battery	47,54,66	49	850	<b>SLK350</b>				
2006	V8 5.0L	47,54	49	950	2013-08	V12 6.0L Starting Motor Battery	45,52,66	V4	520	2014-07	V6 3.5L	54,66	48	680
2005-02	V8 5.0L		49	825	2007-06	V12 6.0L	47,54,66	49	850	2006	V6 3.5L	47,54	98R	760
<b>ML55 AMG</b>					<b>SL320</b>					2005	V6 3.5L	54	49	825
2003-00	V8 5.5L		49	825	1997-95	L6 3.2L		49	825	<b>SLK55 AMG</b>				
<b>ML550</b>					<b>SL500</b>					2014-07	V8 5.5L	54,66	48	680
2014-12	V8 4.6L	54,66	49	850	2006-03	V8 5.0L	47,54,66	48	760	2006	V8 5.5L	47,54	98R	760
2011-08	V8 5.5L	54,66	49	850	2002-95	V8 5.0L	54	49	825	2005	V8 5.5L		49	825
<b>ML63 AMG</b>					<b>SL55 AMG</b>					<b>SLR McLaren</b>				
2014-12	V8 5.5L	54,66	49	850	2008	V8 5.5L On-Board Electrical System Battery	47,54,66	48	760	2009-06	V8 5.5L	47,54	98R	760
2011-07	V8 6.3L	54,66	49	850	2008	V8 5.5L Starting Motor Battery	45,52,66	V4	520	2005	V8 5.5L		49	825
<b>R320</b>					<b>SL550</b>					<b>SLS AMG</b>				
2009-07	V6 3.0L Diesel	47,54,66	49	850	2014-13	V8 4.6L On-Board Electrical System Battery	47,54,66	49	850	2014-11	V8 6.3L	47,54,66	48	760
<b>R350</b>					<b>SL600</b>					<b>Sprinter 2500</b>				
2013-12	V6 3.5L	47,54,66	48	760	2014-13	V8 4.6L Starting Motor Battery	45,52,66	V4	520	<b>Sprinter 3500</b>				
2013-12	V6 3.5L Optional	47,54,66	49	850	2012-07	V8 5.5L On-Board Electrical System Battery	47,54,66	48	760	2014-10	V6 3.0L Diesel	54	49	850
2013-10	V6 3.0L Diesel	47,54,66	49	850	2012-07	V8 5.5L Starting Motor Battery	45,52,66	V4	520	<b>MERCURY</b>				
2011-08	V6 3.5L	47,54,66	49	850	<b>SL63 AMG</b>					<b>Cougar</b>				
2007-06	V6 3.5L	47,54,66	49	950	2014-13	V8 5.5L On-Board Electrical System Battery	47,54,66	48	760	2002-99	L4 2.0L		40R	590
<b>R500</b>					2011-08	V12 5.5L On-Board Electrical System Battery	47,54,66	48	760	2002-99	V6 2.5L		40R	590
2007-06	V8 5.0L	47,54,66	49	950	2011-08	V12 5.5L Starting Motor Battery	45,52,66	V4	520	1997-95	V6 3.8L Canada & Optional		65	650
<b>R63 AMG</b>					2007-04	V12 5.5L	47,54,66	48	760	1997-95	V8 4.6L		65	650
2007	V8 6.3L	47,54,66	49	850	2002-95	V12 6.0L	54	49	825	1997	V6 3.8L U.S.		59	540
<b>S320</b>					<b>SL65 AMG</b>					1996	V6 3.8L U.S., Early		58	540
1999-95	L6 3.2L	47,54	49	825	2014-13	V8 5.5L On-Board Electrical System Battery	47,54,66	48	760	1996	V6 3.8L U.S., Late		59	540
<b>S350</b>					2014-13	V8 6.3L On-Board Electrical System Battery	47,54,66	48	760	1995	V6 3.8L U.S.		58	540
2013-12	V6 3.0L Diesel	47,54,66	49	850	2012-09	V8 6.3L Starting Motor Battery	45,52,66	V4	520	<b>Grand Marquis</b>				
2006	V6 3.7L	47,54,66	49	850	2012-09	V8 6.3L On-Board Electrical System Battery	47,54,66	48	760	2011-09	V8 4.6L Optional		65	750
1995	L6 3.4L Diesel	47,54,66	49	760	2012-09	V8 6.3L Starting Motor Battery	45,52,66	V4	520	2011-07	V8 4.6L		65	650
<b>S400</b>					<b>SL63 AMG</b>					2006-98	V8 4.6L U.S.		65	650
2013-10	V6 3.5L Hybrid	54,66,69	48	760	2014-13	V8 5.5L On-Board Electrical System Battery	47,54,66	48	760	2006-97	V8 4.6L Canada or Optional		65	750
<b>S420</b>					2014-13	V8 5.5L Starting Motor Battery	45,52,66	V4	520	1997	V8 4.6L U.S.		59	540
1999-95	V8 4.2L	47,54	49	825	2012-09	V8 6.3L On-Board Electrical System Battery	47,54,66	48	760	1996-95	V8 4.6L Police Package		65	850
<b>S430</b>					2012-09	V8 6.3L Starting Motor Battery	45,52,66	V4	520	1996-95	V8 4.6L U.S. Opt. or Canada		65	750
2006	V8 4.3L	47,54	49	850	<b>SL65 AMG</b>					1996	V8 4.6L U.S., Early		58	540
2005-00	V8 4.3L	47,54	49	825	2014-13	V12 6.0L On-Board Electrical System Battery	47,54,66	48	760	1996	V8 4.6L U.S., Late		59	540
<b>S450</b>					2014-13	V12 6.0L Starting Motor Battery	45,52,66	V4	520	1995	V8 4.6L U.S.		58	540
2011-08	V8 4.6L On-Board Electrical System Battery	47,54,66	49	850	2011-08	V12 6.0L On-Board Electrical System Battery	47,54,66	48	760	<b>Marauder</b>				
2011-08	V8 4.6L Starting Motor Battery	45,52,66	V4	520	2011-08	V12 6.0L Starting Motor Battery	45,52,66	V4	520	2004-03	V8 4.6L		65	650
<b>S500</b>					2007-05	V12 6.0L	47,54,66	48	760	<b>Mariner</b>				
2006-02	V8 5.0L	47,54,66	49	850	<b>SLK230</b>					2011-10	L4 2.5L Gas		96R	500
2001-95	V8 5.0L	47,54,66	49	760	2004	L4 2.3L	39	48	690	2011-10	V6 3.0L		96R	590
<b>S55 AMG</b>					2003-02	L4 2.3L		48	690	2011-09	L4 2.5L Hybrid		96R	500
2006	V8 5.5L	47,54	49	850	2001-00	L4 2.3L		49	825	2009-05	V6 3.0L		40R	590
2005-04	V8 5.5L	47,54	49	825	1999-98	L4 2.3L		48	690	2009	L4 2.5L Gas		40R	590
2003	V8 5.5L	54	49	850	<b>SLK250</b>					2008-06	L4 2.3L Gas		40R	590
2002-01	V8 5.5L	47,54	49	825	2014-12	L4 1.8L	47,54,66	48	760	2008-06	L4 2.3L Hybrid		96R	500
<b>S550</b>					<b>SLK230</b>					2005	L4 2.3L		40R	590
2014-12	V8 4.6L On-Board Electrical System Battery	47,54,66	49	850	2004	L4 2.3L	39	48	690	<b>Milan</b>				
2014-12	V8 4.6L Starting Motor Battery	45,52,66	V4	520	2003-02	L4 2.3L		48	690	2011-10	L4 2.5L Gas		96R	500
2011-08	V8 5.5L On-Board Electrical System Battery	47,54,66	49	850	2001-00	L4 2.3L		49	825	2011-10	L4 2.5L Hybrid		67R	390
2011-08	V8 5.5L Starting Motor Battery	45,52,66	V4	520	1999-98	L4 2.3L		48	690	2011-10	V6 3.0L		96R	500
2007-07	V8 5.5L	47,54,66	49	850	<b>SLK230</b>					2009	L4 2.3L Gas		96R	500
					2004	L4 2.3L	39	48	690	2009	L4 2.3L Hybrid		67R	390
					2003-02	L4 2.3L		48	690	2009	V6 3.0L		96R	590
					2001-00	L4 2.3L		49	825	2008	L4 2.3L		96R	500
					1999-98	L4 2.3L		48	690	2008	V6 3.0L		96R	500
					<b>SLK250</b>					2007-06	L4 2.3L		40R	590
					2014-12	L4 1.8L	47,54,66	48	760	2007-06	V6 3.0L		40R	590

# Passenger Car & Light Truck

YEAR	ENGINE/ OPTIONS	FOOT NOTE	GROUP/ TYPE NO.	O.E. CCA (@0°F)	YEAR	ENGINE/ OPTIONS	FOOT NOTE	GROUP/ TYPE NO.	O.E. CCA (@0°F)	YEAR	ENGINE/ OPTIONS	FOOT NOTE	GROUP/ TYPE NO.	O.E. CCA (@0°F)
<b>MERCURY (Cont.)</b>					<b>MITSUBISHI</b>					<b>MITSUBISHI (Cont.)</b>				
<b>Montego</b>					<b>3000GT</b>					<b>Raider</b>				
2007	V6 3.0L		36R	540	1999-96	V6 3.0L		25	520	2009-06	V6 3.7L		65	600
2006-05	V6 3.0L		36R	600	1995	V6 3.0L		24	430	2007-06	V8 4.7L		65	600
<b>Monterey</b>					<b>Diamante</b>					2006 V6 3.7L Optional 65 650				
2007	V6 4.2L		65	750	2004	V6 3.5L		24	600	2006	V8 4.7L Optional		65	650
2006-04	V6 4.2L		59	540	2003-99	V6 3.5L		86	520	<b>RVR</b>				
2006-04	V6 4.2L Optional		65	750	1998-97	V6 3.5L		24	490	2014-11	L4 2.0L		35	520
<b>Mountaineer</b>					1996-95 V6 3.0L 24 490					<b>NISSAN</b>				
2010-98	V6 4.0L		65	650	<b>Eclipse</b>					<b>200SX</b>				
2010-02	V8 4.6L		65	650	2012-06	V6 3.8L		24	550	1998-95	L4 1.6L Canada		24F	550
2001-97	V8 5.0L		65	650	2012-00	L4 2.4L		86	525	1998-95	L4 1.6L U.S.		35	490
<b>Mystique</b>					2005-00 V6 3.0L 86 525					1998-95 L4 2.0L Canada 24F 550				
2000-98	L4 2.0L		40R	590	1999-96	L4 2.4L		86	430	1998-95	L4 2.0L U.S.		35	490
2000-98	V6 2.5L		40R	590	1999	L4 2.0L		86	525	1995	L4 2.0L Optional		24F	550
1997-95	L4 2.0L		96R	590	1998-95	L4 2.0L AT		86	525	<b>240SX</b>				
1997-95	L4 2.0L Optional		40R	650	1998-95	L4 2.0L MT ex. Turbo		86	430	1998-95	L4 2.4L Canada & Optional		24	415
1997-95	V6 2.5L		40R	650	1998-95	L4 2.0L Turbo		86	525	1998-95	L4 2.4L U.S.		25	360
<b>Sable</b>					<b>Endeavor</b>					<b>300ZX</b>				
2009-08	V6 3.5L		59	540	2011-10	V6 3.8L		24	550	1996-95	V6 3.0L Conv.		35	550
2005	V6 3.0L DOHC, Opt. & Canada		36R	600	2008-04	V6 3.8L		24	550	1996-95	V6 3.0L ex. Conv.		24F	575
2005	V6 3.0L OHV		36R	600	<b>Expo</b>					<b>350Z</b>				
2004	V6 3.0L U.S.		36R	540	1995	L4 2.4L		24	490	2009-03	V6 3.5L		35	585
2004	V6 3.0L U.S. Opt. or Canada		36R	600	<b>Galant</b>					<b>370Z</b>				
2003-02	V6 3.0L DOHC, Opt. & Canada		36R	600	2012-99	L4 2.4L		86	525	2014-09	V6 3.7L		35	585
2003-02	V6 3.0L OHV		36R	600	2009-04	V6 3.8L		24	550	<b>Altima</b>				
2001	V6 3.0L U.S.		36R	540	2003-99	V6 3.0L		86	525	2014-12	L4 2.5L		35	550
2001	V6 3.0L U.S. Opt. or Canada		36R	600	1998-95	L4 2.4L		26	490	2014-07	V6 3.5L		35	550
2000-96	V6 3.0L SOHC		58R	540	<b>i-MiEV</b>					2011-07 L4 2.5L Gas 35 550				
2000	V6 3.0L DOHC, Opt. & Canada		36R	600	2014	Electric		151R	370	2011-07	L4 2.5L Hybrid	54	34	700
1999-96	V6 3.0L DOHC, Opt. & Canada		36R	600	2012	Electric		151R	370	2006-02	L4 2.5L		24F	550
1995	V6 3.0L		58	540	<b>Lancer</b>					2006-02 V6 3.5L 24F 550				
1995	V6 3.0L Optional		65	650	2014-09	L4 2.4L		35	520	2006-02	V6 3.5L		24F	550
1995	V6 3.8L ex. HWS or Police		65	650	2014-08	L4 2.0L ex. Evolution		35	520	2001-96	L4 2.4L		24F	550
1995	V6 3.8L HWS or Police		65	850	2013-08	L4 2.0L Evolution	45,54	N/A	700	1995	L4 2.4L Canada & Optional		24F	585
1995	V6 3.8L Police or Optional		65	850	2007	L4 2.0L		35	550	1995	L4 2.4L U.S.		35	350
<b>Tracer</b>					<b>Mighty Max</b>					<b>Armada</b>				
1999-98	L4 2.0L		58	500	1996-95	L4 2.4L		51	435	2014-05	V8 5.6L ex. Tow Pkg		24F	650
1997	L4 2.0L		58	540	<b>Mirage</b>					2014-05 V8 5.6L w/Tow Pkg 27F 710				
1996-95	L4 1.8L		35	540	2002-98	L4 1.5L		35	435	<b>Cube</b>				
1996-95	L4 1.9L		35	460	2002-98	L4 1.8L		35	435	2014-09	L4 1.8L		35	410
<b>Villager</b>					1997 L4 1.5L 51R 435					<b>Frontier</b>				
2002-99	V6 3.3L Canada or Optional		24F	525	1997	L4 1.8L		51R	435	2014-11	L4 2.5L		35	550
2002-99	V6 3.3L U.S.		35	450	1996-95	L4 1.5L		51	430	2014-11	V6 4.0L		35	550
1998-95	V6 3.0L Canada or Optional		24F	525	1996-95	L4 1.8L		51	430	2010	L4 2.5L		24F	575
1998-95	V6 3.0L U.S.		35	450	<b>Montero</b>					2010 V6 4.0L 24F 575				
<b>MINI</b>					2006-03 V6 3.8L 24F 585					2009-05 L4 2.5L 24F 550				
<b>Cooper</b>					2002-01 V6 3.5L 24F 585					2009-05 V6 4.0L 24F 550				
2014-11	L4 1.6L Optional	9,54,57,66,67,69	47	680	2002	V6 3.5L Optional		27F	675	2004-03	L4 2.4L		25	490
2014-10	L4 1.6L	45,52,54,57,66,67	L1	480	2000-95	V6 3.5L		24	490	2004-03	L4 2.4L Optional		24	575
2014-10	L4 1.6L Optional	54,57,66,67	48	570	1996-95	V6 3.0L		24	490	2004-03	V6 3.3L		24	575
2010	L4 1.6L Optional	9,54,66	47	480	<b>Montero Sport</b>					2002-99 V6 3.3L Canada & Optional 24 550				
2009-02	L4 1.6L ex. Turbo or Supercharged		47	480	2004	V6 3.5L		24	585	2002-99	V6 3.3L U.S.		25	490
2009-02	L4 1.6L Turbo or Supercharged	54	47	480	2003-97	V6 3.0L Optional		24	585	2002-98	L4 2.4L Canada & Optional		24	550
<b>Cooper Countryman</b>					2003 V6 3.5L Optional 24 585					2002-98 L4 2.4L U.S. 25 490				
2014-11	L4 1.6L	45,52,54,57,66,67	L1	480	2002-97	V6 3.0L		25	520	<b>GT-R</b>				
2014-11	L4 1.6L Optional	9,54,57,66,67,69	47	680	2002	V6 3.5L		24	585	2014-09	V6 3.8L		51R	410
2014-11	L4 1.6L Optional	54,57,66,67	48	570	2001-99	V6 3.5L		25	520	<b>Juke</b>				
<b>Cooper Paceman</b>					2000-99 V6 3.5L Optional 24 585					2014-11 L4 1.6L 35 550				
2014-13	L4 1.6L	45,52,54,57,66,67	L1	480	1999-97	L4 2.4L		25	520	<b>Maxima</b>				
2014-13	L4 1.6L Optional	9,54,57,66,67,69	47	680	1999-97	L4 2.4L Optional		24	585	2014-09	V6 3.5L		35	550
2014-13	L4 1.6L Optional	54,57,66,67	48	570	<b>Outlander</b>					2008-04 V6 3.5L 24F 550				
<b>Cooper Countryman</b>					2014-08 L4 2.4L 35 520					2003 V6 3.5L 24F 445				
2014-13	L4 1.6L	45,52,54,57,66,67	L1	480	2014	V6 3.0L		24F	585	2002	V6 3.5L		24F	585
2014-13	L4 1.6L Optional	9,54,57,66,67,69	47	680	2013-12	V6 3.0L		35	520	2001-00	V6 3.0L		24F	585
2014-13	L4 1.6L Optional	54,57,66,67	48	570	2011-07	V6 3.0L		24F	585	1999-95	V6 3.0L Calif. & Canada		24F	585
<b>Cooper Paceman</b>					2006 L4 2.4L 35 520					1999-95 V6 3.0L Optional 24F 585				
2014-13	L4 1.6L	45,52,54,57,66,67	L1	480	2006	L4 2.4L Optional		24F	620	1999-95	V6 3.0L U.S. ex. California		35	360
2014-13	L4 1.6L Optional	9,54,57,66,67,69	47	680	2005-04	L4 2.4L		24F	620	<b>Murano</b>				
2014-13	L4 1.6L Optional	54,57,66,67	48	570	2003	L4 2.4L		35	520	2014-09	V6 3.5L		35	585
<b>Cooper Countryman</b>					<b>Outlander Sport</b>									
2014-13	L4 1.6L	45,52,54,57,66,67	L1	480	2014-11	L4 2.0L		35	520					

# Passenger Car & Light Truck

YEAR	ENGINE/ OPTIONS	FOOT NOTE	GROUP/ TYPE NO.	O.E. CCA (@0°F)	YEAR	ENGINE/ OPTIONS	FOOT NOTE	GROUP/ TYPE NO.	O.E. CCA (@0°F)	YEAR	ENGINE/ OPTIONS	FOOT NOTE	GROUP/ TYPE NO.	O.E. CCA (@0°F)
<b>NISSAN (Cont.)</b>					<b>NISSAN (Cont.)</b>					<b>OLDSMOBILE (Cont.)</b>				
<b>Murano (Cont.)</b>					<b>Titan (Cont.)</b>					<b>Cutlass (Cont.)</b>				
2007-04	V6 3.5L w/Intelligent Key		24F	700	2008	V8 5.6L Flex Fuel		27F	710	1997	V6 3.1L		78	600
2007-04	V6 3.5L w/o Intelligent Key		24F	575	2008	V8 5.6L Gas		24F	650	<b>Cutlass Ciera</b>				
2003	V6 3.5L		35	490	2007	V8 5.6L		24F	650	1996-95	L4 2.2L		75	525
<b>NV1500</b>					2006	V8 5.6L ex. Tow Pkg		24F	650	1996	V6 3.1L		78	600
2014-12	V6 4.0L		24F	650	2006	V8 5.6L w/ Tow Package or Optional		27F	710	1995	V6 3.1L Early		75	525
<b>NV200</b>					2005-04	V8 5.6L		24F	650	1995	V6 3.1L Late		78	600
2014-13	L4 2.0L		24F	650	<b>Versa</b>					<b>Cutlass Supreme</b>				
<b>NV2500</b>					2014-13	L4 1.6L ex. CVT- Transmission	45	T4	470	1997-96	V6 3.1L		78	600
2014-12	V6 4.0L ex. Tow Pkg		24F	650	2014-09	L4 1.6L CVT- Transmission		51R	410	1996	V6 3.4L		78	690
2014-12	V6 4.0L w/Tow Pkg		27F	710	2012-09	L4 1.6L ex. CVT- Transmission		90	470	1995	V6 3.1L Early		75	525
2014-12	V8 5.6L ex. Tow Pkg		24F	650	2012-07	L4 1.8L CVT- Transmission		51R	410	1995	V6 3.1L Late		78	600
2014-12	V8 5.6L w/Tow Pkg		27F	710	2012-07	L4 1.8L ex. CVT- Transmission		90	470	1995	V6 3.4L Early		75	690
<b>NV3500</b>					<b>Versa Note</b>					<b>Intrigue</b>				
2014-12	V6 4.0L ex. Tow Pkg		24F	650	2014	L4 1.6L	45	T4	470	2002-99	V6 3.5L		78	690
2014-12	V6 4.0L w/Tow Pkg		27F	710	<b>Xterra</b>					<b>LSS</b>				
2014-12	V8 5.6L ex. Tow Pkg		24F	650	2014-10	V6 4.0L		35	550	1999-98	V6 3.8L		78	690
2014-12	V8 5.6L w/Tow Pkg		27F	710	2009-05	V6 4.0L		24F	550	1999-96	V6 3.8L		78	690
<b>Pathfinder</b>					2004	L4 2.4L		25	490	<b>Regency</b>				
2014-13	V6 3.5L		35	550	2004	L4 2.4L Optional		24	550	1998	V6 3.8L		78	690
2012-10	V6 4.0L		35	550	2004	V6 3.3L		25	490	1997	V6 3.8L HWS or Optional		78	770
2012-08	V8 5.6L		24F	650	2004	V6 3.3L Optional		24	550	<b>Silhouette</b>				
2009-07	V6 4.0L		24F	550	2004	V6 3.3L U.S.		25	490	2004-97	V6 3.4L		78	600
2006-05	V6 4.0L		24F	700	2003-00	L4 2.4L Canada & Optional		24	550	1996	V6 3.4L		75	525
2004-03	V6 3.5L		24	455	2003-00	V6 3.3L Canada & Optional		24	550	1995	V6 3.8L		75	630
2004	V8 5.6L		24F	700	2001-00	L4 2.4L Canada & Optional		24	550	<b>PANOZ</b>				
2004	V8 5.6L Optional		27F	710	2001-00	V6 3.3L Canada & Optional		24	550	<b>AIV Roadster</b>				
2002-01	V6 3.5L		25	360	2001-00	V6 3.3L Canada & Optional		24	550	2000-99	V8 4.6L		58R	580
2002-01	V6 3.5L Optional		27	450	<b>X-Trail</b>					<b>Esperante</b>				
2000-96	V6 3.3L Canada & Optional		27	450	2006	L4 2.5L		24F	550	2007-01	V8 4.6L		58R	580
2000-96	V6 3.3L U.S.		25	360	2005	L4 2.5L		35	550	<b>PLYMOUTH</b>				
1995	V6 3.0L Canada		27	450	<b>OLDSMOBILE</b>					<b>Acclaim</b>				
1995	V6 3.0L U.S.		25	360	<b>88</b>					1995	L4 2.5L		34	600
<b>Pickup</b>					<b>88</b>					1995	V6 3.0L		34	500
1997-95	L4 2.4L Canada		24	525	1999	V6 3.8L		78	690	<b>Breeze</b>				
1997-95	L4 2.4L U.S.		25	360	1998	V6 3.8L ex. Supercharged		78	690	2000-97	L4 2.4L		75	510
1996-95	V6 3.0L Canada		24	525	1998	V6 3.8L Supercharged		78	770	2000-96	L4 2.0L		75	510
1996-95	V6 3.0L U.S.		25	360	1997-96	V6 3.8L		78	690	1996	L4 2.4L		75	575
<b>Quest</b>					<b>98</b>					<b>Colt</b>				
2014-11	V6 3.5L		24F	550	1996-95	V6 3.8L HWS or Optional		78	770	1995	L4 1.5L		51	435
2009-04	V6 3.5L		24F	550	<b>Achieva</b>					<b>Grand Voyager</b>				
2002-99	V6 3.3L Canada & Optional		24F	525	1998-96	L4 2.4L		75	600	2000-95	V6 3.0L		34	500
2002-99	V6 3.3L U.S.		35	450	1998-95	V6 3.1L		75	600	2000-95	V6 3.3L		34	500
1998-96	V6 3.0L Canada		24F	525	1995	L4 2.3L		75	600	1999-95	V6 3.0L Optional		34	685
1998-95	V6 3.0L U.S.		35	450	<b>Alero</b>					1999-95	V6 3.0L Optional		34	685
1995	V6 3.0L Canada & Optional		24F	525	2004-99	V6 3.4L		75	600	1999-95	V6 3.3L Optional		34	600
<b>Rogue</b>					<b>2001-99</b>					<b>1999-95</b>				
2014-08	L4 2.5L		35	585	2004-99	L4 2.2L		75	600	1999-95	V6 3.8L Optional		34	685
<b>Sentra</b>					<b>2001-99</b>					<b>1997-96</b>				
2014-13	L4 1.8L		21R	470	2004	L4 2.2L		75	600	1997-96	L4 2.4L		34	600
2012-09	L4 2.5L		40R	550	2003-02	L4 2.2L		75	600	1997-96	L4 2.4L Optional		34	685
2012-07	L4 2.0L		21R	470	2001-99	L4 2.4L		75	600	<b>Neon</b>				
2008-06	L4 2.5L		35	550	<b>Aurora</b>					<b>2001-00</b>				
2006	L4 1.8L		35	550	2003-01	V8 4.0L	54	100	770	2001-00	L4 2.0L		26R	450
2005-03	L4 2.5L		35	355	2002-01	V6 3.5L	54	100	770	2001-00	L4 2.0L Optional	35	26R	540
2005-00	L4 1.8L		35	355	1999-98	V8 4.0L	54	79	840	1999-95	L4 2.0L		58	450
2002	L4 2.5L		21R	490	1997-95	V8 4.0L	54	76	970	<b>Prowler</b>				
2001	L4 2.0L		21R	490	<b>Bravada</b>					<b>2001-99</b>				
2000-99	L4 2.0L		35	490	2004-02	L6 4.2L		78	600	2001-99	V6 3.5L		34	525
1999	L4 1.6L		35	490	2001-96	V6 4.3L		75	525	1997	V6 3.5L		34	525
1998-95	L4 1.6L Canada		24F	550	2001-96	V6 4.3L Optional		75	690	<b>Voyager</b>				
1998-95	L4 1.6L U.S.		35	490	<b>Cutlass</b>					<b>2000-96</b>				
1998	L4 2.0L Canada		24F	550	1999-98	V6 3.1L		75	600	2000-96	L4 2.4L		34	600
1998	L4 2.0L U.S.		35	490	<b>NISSAN (Cont.)</b>					<b>2000-95</b>				
<b>Titan</b>					<b>2001-99</b>					<b>1999-95</b>				
2014-10	V8 5.6L ex. Tow Pkg		24F	650	<b>OLDSMOBILE</b>					<b>1999-95</b>				
2014-10	V8 5.6L w/Tow Pkg		27F	710	<b>88</b>					<b>1997-96</b>				
2009	V8 5.6L		24F	650	<b>88</b>					<b>1995</b>				

# Passenger Car & Light Truck

YEAR	ENGINE/ OPTIONS	FOOT NOTE	GROUP/ TYPE NO.	O.E. CCA (@0°F)	YEAR	ENGINE/ OPTIONS	FOOT NOTE	GROUP/ TYPE NO.	O.E. CCA (@0°F)	YEAR	ENGINE/ OPTIONS	FOOT NOTE	GROUP/ TYPE NO.	O.E. CCA (@0°F)
<b>PONTIAC (Cont.)</b>					<b>PONTIAC (Cont.)</b>					<b>PORSCHE (Cont.)</b>				
<b>Bonneville</b>					<b>Pursuit</b>					<b>Cayman (Cont.)</b>				
2005-04	V6 3.8L	54	100	770	2006-05	L4 2.2L		90	600	2009-06	H6 3.4L	54	94R	740
2005-04	V8 4.6L	54	100	770	2006	L4 2.4L		90	600	2008-07	H6 2.7L	54	94R	740
2003-02	V6 3.8L ex. Supercharged	54	100	770	<b>Solstice</b>					<b>Panamera</b>				
2003-02	V6 3.8L Supercharged	54	79	800	2009-08	L4 2.0L		86	590	2014-12	V6 3.0L	54	49	740
2001-00	V6 3.8L ex. Supercharged	54	79	840	2009-08	L4 2.4L		86	590	2014-11	V6 3.6L	54	49	740
2001-00	V6 3.8L Supercharged	54	79	840	2007	L4 2.0L		86	640	2014-10	V8 4.8L	54	49	740
1999-98	V6 3.8L ex. Supercharged	78		690	2007	L4 2.4L		86	640	<b>RAM</b>				
1999-98	V6 3.8L Supercharged	78		770	2006	L4 2.4L		86	590	<b>1500</b>				
1997-95	V6 3.8L	78		690	<b>Sunfire</b>					2014-13 V6 3.6L				
1997-95	V6 3.8L Optional	78		770	2005-95	L4 2.2L		75	525	2014-11	V8 5.7L		94R	730
<b>Firebird</b>					2002	L4 2.4L		75	525	2014	V6 3.0L Diesel	47	49	800
2002-95	V6 3.8L		75	690	2001-96	L4 2.4L		75	600	2013-11	V8 4.7L		94R	730
2002-95	V8 5.7L		75	525	1995	L4 2.3L		75	600	2012-11	V6 3.7L		94R	730
1995	V6 3.4L		75	525	<b>Sunrunner</b>					<b>2500</b>				
<b>Firefly</b>					1997-95	L4 1.6L		26R	390	2014-11	L6 6.7L Diesel	2	94R	730
2000-95	L3 1.0L		26R	390	<b>Torrent</b>					2014-11	V8 5.7L		94R	730
2000-95	L4 1.3L		26R	390	2009-08	V6 3.6L		47	650	2014	V8 6.4L		94R	730
<b>G3</b>					2009-07	V6 3.4L		47	650	<b>3500</b>				
2010-09	L4 1.6L		86	590	2006	V6 3.4L		75	600	2014-11	L6 6.7L Diesel	2	94R	730
<b>G3 Wave</b>					<b>Trans Sport</b>					2014-11	V8 5.7L		94R	730
2009	L4 1.6L		86	550	1999-97	V6 3.4L		78	600	2014	V8 6.4L		94R	730
<b>G5</b>					1996	V6 3.4L		75	525	<b>4500</b>				
2010-09	L4 1.6L		86	590	1995	V6 3.1L		75	525	2014-11	L6 6.7L Diesel	2	94R	730
<b>G5</b>					1995	V6 3.8L		75	630	2014	V8 6.4L		94R	730
2010-09	L4 2.2L	54	90	590	<b>Vibe</b>					<b>5500</b>				
2008-07	L4 2.2L	54	90	600	2010-09	L4 2.4L		24F	575	2014-11	L6 6.7L Diesel	2	94R	730
2008-07	L4 2.4L		90	600	2010-03	L4 1.8L		35	550	2014	V8 6.4L		94R	730
<b>G6</b>					<b>Wave</b>					<b>C/V</b>				
2010-08	L4 2.4L		90	590	2008-05	L4 1.6L		86	550	2014-12	V6 3.6L		94R	730
2010-08	V6 3.5L		90	590	<b>Wave5</b>					<b>Dakota</b>				
2009-08	V6 3.6L		90	590	2007-05	L4 1.6L		86	590	2011	V6 3.7L		65	600
2009-08	V6 3.9L		90	590	<b>PORSCHE</b>					2011	V6 3.7L Optional		65	750
2007-06	L4 2.4L		75	525	<b>911</b>					2011	V8 4.7L		65	600
2007-06	V6 3.9L		75	525	2014-12	H6 3.4L	54	49	740	2011	V8 4.7L Optional		65	750
2007-05	V6 3.5L		75	525	2014-10	H6 3.8L	54	49	740	<b>ProMaster 1500</b>				
2007	V6 3.6L		75	525	2012-10	H6 3.6L	54	49	740	2014	L4 3.0L Diesel		49	800
<b>G8</b>					2011	H6 4.0L	54	49	740	2014	V6 3.6L		49	800
2009	V6 3.6L	54	94R	720	2009-05	H6 3.6L	54	94R	740	<b>ProMaster 2500</b>				
2009	V8 6.0L	54	94R	720	2009-05	H6 3.8L	54	94R	740	2014	L4 3.0L Diesel		49	800
2009	V8 6.2L	54	94R	720	2004-02	H6 3.6L ex. GT2	9,54	94R	740	2014	V6 3.6L		49	800
2008	V6 3.6L	54	94R	700	2004-02	H6 3.6L GT2	9,54	91	650	<b>ProMaster 3500</b>				
2008	V8 6.0L	54	94R	700	2001-99	H6 3.4L	54	48	650	2014	L4 3.0L Diesel		49	800
<b>Grand Am</b>					2001	H6 3.6L ex. GT2	9,54	91	650	2014	V6 3.6L		49	800
2005-99	V6 3.4L		75	600	2001	H6 3.6L GT2	9,54	48	650	<b>ROLLS ROYCE</b>				
2005	L4 2.2L		75	600	1998-95	H6 3.6L	54	48	650	<b>Ghost</b>				
2004	L4 2.2L		75	525	<b>928</b>					2014-10 V12 6.6L 54,66,69 49 900				
2003-02	L4 2.2L		75	600	1995	V8 5.4L		48	650	<b>Phantom</b>				
2001-96	L4 2.4L		75	600	<b>968</b>					2014-04 V12 6.7L 54,66,69 48 760				
1998-95	V6 3.1L		75	600	1995	L4 3.0L		91	600	2014-04	V12 6.7L Optional	54,66,69	49	900
1995	L4 2.3L		75	600	<b>Boxster</b>					<b>Wraith</b>				
<b>Grand Prix</b>					2014-13	H6 2.7L	54	94R	650	2014	V12 6.6L	54,66,69	49	900
2008-06	V6 3.8L	47	34	690	2014-07	H6 3.4L	54	94R	650	<b>SAAB</b>				
2008	V8 5.3L		85	590	2012-09	H6 2.9L	54	94R	650	<b>900</b>				
2007-05	V8 5.3L		85	625	2008-06	H6 2.7L	54	94R	650	1998-95	L4 2.0L		47	520
2005-04	V6 3.8L	47	34	680	2006	H6 3.2L	54	94R	650	1998-95	L4 2.3L		47	520
2003-97	V6 3.8L ex. Supercharged		78	690	2005-02	H6 2.7L Optional	54	94R	650	1997-95	V6 2.5L		47	520
2003-97	V6 3.8L Supercharged		78	770	2005-02	H6 3.2L Optional	54	94R	650	<b>9000</b>				
2003-96	V6 3.1L		78	600	2005-00	H6 2.7L	54	48	650	1998-95	L4 2.3L		41	570
1996	V6 3.4L		78	690	2005-00	H6 2.7L	54	48	650	1997-95	V6 3.0L		41	570
1995	V6 3.1L Early		75	525	1999-97	H6 2.5L	54	48	650	<b>9-2X</b>				
1995	V6 3.1L Late		78	600	<b>Carrera GT</b>					2006 H4 2.5L 35 550				
1995	V6 3.4L Early		75	690	2005-04	V10 5.7L	54	48	650	2005	H4 2.0L		25	550
1995	V6 3.4L Late		78	690	<b>Cayenne</b>					2005	H4 2.5L		25	550
<b>GTO</b>					2014-11	V6 3.0L Hybrid	54	94R	650	<b>9-3</b>				
2006-05	V8 6.0L		85	600	2014-08	V6 3.6L	54	94R	650	2011-04	L4 2.0L	54	48	700
2004	V8 5.7L		85	600	2014-08	V8 4.8L	54	49	740	2009-06	V6 2.8L	54	48	700
<b>Montana</b>					2006-04	V6 3.2L	54	94R	640	2003-03	L4 2.0L Conv.	40	47	580
2009-06	V6 3.9L		34	600	2006-03	V8 4.5L	54	49	740	2003-03	L4 2.0L Sport Sedan	54	48	700
2006-05	V6 3.5L		34	600	<b>Cayman</b>					2002	L4 2.0L	40	47	580
2005-99	V6 3.4L		78	600	2014	H6 2.7L	54	49	740					
					2014	H6 3.4L	54	49	740					
					2012-10	H6 3.4L	54	49	740					
					2012-09	H6 2.9L	54	49	740					

# Passenger Car & Light Truck

YEAR	ENGINE/ OPTIONS	FOOT NOTE	GROUP/ TYPE NO.	O.E. CCA (@0°F)	YEAR	ENGINE/ OPTIONS	FOOT NOTE	GROUP/ TYPE NO.	O.E. CCA (@0°F)	YEAR	ENGINE/ OPTIONS	FOOT NOTE	GROUP/ TYPE NO.	O.E. CCA (@0°F)
<b>SAAB (Cont.)</b>					<b>SATURN (Cont.)</b>					<b>SUBARU (Cont.)</b>				
<b>9-3 (Cont.)</b>					<b>LW300</b>					<b>BRZ</b>				
2002	L4 2.3L	40	47	580	2003-02	V6 3.0L		78	600	2014-13	H4 2.0L		35	550
2001-99	L4 2.0L		47	580	2001	V6 3.0L		75	525	<b>Forester</b>				
2001-99	L4 2.3L		47	580	<b>Outlook</b>					2014-10	H4 2.5L		35	550
<b>9-3X</b>					2010	V6 3.6L	54	48	660	2014	H4 2.0L		35	550
2011-10	L4 2.0L	54	48	700	2009-07	V6 3.6L	54	48	730	2009-08	H4 2.5L		35	490
<b>9-4X</b>					<b>Relay</b>					2007	H4 2.5L		35	500
2011	V6 2.8L	54	48	700	2007-06	V6 3.9L		34	600	2006	H4 2.5L AT		35	490
2011	V6 3.0L	54	48	700	2006-05	V6 3.5L		34	600	2006	H4 2.5L MT		35	360
<b>9-5</b>					<b>SC1</b>					2005-03	H4 2.5L AT		35	520
2011-10	V6 2.8L	54	48	700	2002-95	L4 1.9L		75	525	2005	H4 2.5L MT		35	430
2011	L4 2.0L	54	48	700	<b>SC2</b>					2004-03	H4 2.5L MT		35	360
2009-08	L4 2.3L	54	48	700	2002-95	L4 1.9L		75	525	2002-00	H4 2.5L		35	360
2007-04	L4 2.3L		48	700	<b>Sky</b>					2002-00	H4 2.5L Optional		35	520
2003-02	L4 2.3L	54	48	700	2010-07	L4 2.0L		86	590	1999-98	H4 2.5L AT		35	520
2003-02	V6 3.0L		48	700	2010-07	L4 2.4L		86	590	1999-98	H4 2.5L MT		35	360
2001-99	V6 3.0L		48	650	<b>SL</b>					<b>Impreza</b>				
2001-00	L4 2.3L		48	650	2002-95	L4 1.9L		75	525	2014-12	H4 2.0L		35	550
1999	L4 2.3L		48	700	<b>SL1</b>					2014-10	H4 2.5L		35	550
<b>9-7x</b>					2002-95	L4 1.9L		75	525	2009-07	H4 2.5L		35	520
2009-08	V8 6.0L		78	600	1999-95	L4 1.9L		75	525	2006	H4 2.5L AT		35	490
2009-05	L6 4.2L		78	600	<b>SL2</b>					2006	H4 2.5L MT		35	420
2009-05	V8 5.3L		78	600	2002-95	L4 1.9L		75	525	2005-02	H4 2.5L AT		35	520
<b>SALEEN</b>					<b>SW1</b>					2005	H4 2.0L AT		35	520
<b>S7</b>					1999-95	L4 1.9L		75	525	2005	H4 2.0L MT		35	430
2006-02	V8 7.0L		34	750	<b>SW2</b>					2005	H4 2.5L MT		35	430
<b>SATURN</b>					2001-95	L4 1.9L		75	525	2004-02	H4 2.0L AT		35	420
<b>Astra</b>					<b>Vue</b>					2004-02	H4 2.0L MT		35	360
2009-08	L4 1.8L		91	600	2010-08	L4 2.4L		47	650	2004-02	H4 2.5L MT		35	360
<b>Aura</b>					2010-08	V6 3.5L		48	730	2001-95	H4 2.2L AT		35	520
2009	L4 2.4L		90	600	2010-08	V6 3.6L		48	730	2001-95	H4 2.2L MT		35	360
2009	V6 3.6L		90	600	2007	L4 2.2L		75	525	2001	H4 2.5L		35	520
2008	L4 2.4L		90	590	2007	L4 2.4L		86	590	2000-98	H4 2.5L AT		35	520
2008	V6 3.5L		90	590	2007	V6 3.5L		86	640	2000-98	H4 2.5L MT		35	360
2008	V6 3.6L		90	590	2006-04	L4 2.2L		75	550	1997-95	H4 1.8L AT		35	520
2007	L4 2.4L XE		75	575	2003-02	L4 2.2L		75	600	1997-95	H4 1.8L MT		35	360
2007	L4 2.4L XR		75	690	2003-02	V6 3.0L		75	600	<b>Justy</b>				
2007	V6 3.5L		75	690	<b>SCION</b>					1995	L3 1.2L		35	550
2007	V6 3.6L		75	690	<b>FR-S</b>					<b>Legacy</b>				
<b>Ion</b>					2014-13	H4 2.0L	45,54	55D23L	430	2014-10	H4 2.5L		25	490
2007-04	L4 2.0L	54	78	600	<b>iQ</b>					2014-10	H6 3.6L		25	490
2007	L4 2.2L	54	78	600	2014-12	L4 1.3L		51	295	2009-08	H6 3.0L		35	490
2007	L4 2.4L	54	78	600	2014-12	L4 1.3L Optional, Cold Climate		35	320	2009	H4 2.5L		35	490
2006	L4 2.2L From June	54	78	600	<b>tC</b>					2008	H4 2.5L		85	430
2006	L4 2.2L To June	54	75	600	2014-11	L4 2.5L		24F	575	2007	H4 2.5L		35	490
2006	L4 2.4L From June	54	78	600	2010	L4 2.4L		24F	575	2006-98	H4 2.5L MT		35	430
2006	L4 2.4L To June	54	75	600	2009-05	L4 2.4L		24	575	2006	H4 2.5L AT or Optional		35	490
2005-03	L4 2.2L	54	75	600	<b>xA</b>					2005-96	H4 2.5L AT		35	490
<b>L100</b>					2006-04	L4 1.5L		25	550	2000	H4 2.5L Optional		85	430
2002	L4 2.2L		78	600	<b>xB</b>					1999-98	H4 2.2L MT		35	430
2001	L4 2.2L		75	525	2014-08	L4 2.4L		24F	575	1999-95	H4 2.2L AT		35	490
<b>L200</b>					2006-04	L4 1.5L		25	550	1999-95	H4 2.2L Optional		85	430
2003-02	L4 2.2L		78	600	<b>xD</b>					1997-96	H4 2.5L MT		35	355
2001	L4 2.2L		75	525	2014-08	L4 1.8L		35	550	1997-95	H4 2.2L MT		35	355
<b>L300</b>					<b>SMART</b>					<b>Outback</b>				
2005-02	V6 3.0L		78	600	<b>Fortwo</b>					2014-10	H4 2.5L		25	490
2004	L4 2.2L		78	600	2014-08	L3 1.0L	54,66	47	540	2014-10	H6 3.6L		25	490
2001	V6 3.0L		75	525	2007-05	L3 0.8L	54,66	47	540	2009-07	H4 2.5L		35	490
<b>LS</b>					<b>SRT</b>					2009-07	H4 2.5L		35	490
2000	L4 2.2L		75	525	<b>Viper</b>					2009-07	H6 3.0L		35	490
<b>LS1</b>					<b>2014-13 V10 8.4L</b>					2006	H6 3.0L AT		35	490
2000	L4 2.2L		75	525	2014-13	V10 8.4L	54	90	590	2006	H6 3.0L MT		35	430
<b>LS2</b>					<b>SUBARU</b>					2006	H6 3.0L MT		35	430
2000	V6 3.0L		75	525	<b>B9 Tribeca</b>					2005-01	H6 3.0L		35	490
<b>LW1</b>					<b>Baja</b>					2000	H4 2.5L		35	490
2000	L4 2.2L		75	525	2007-06	H6 3.0L		35	490	<b>SVX</b>				
<b>LW2</b>					<b>2006-03 H4 2.5L AT</b>					1997-95	H6 3.3L		24	585
2000	V6 3.0L		75	525	2006-03	H4 2.5L MT		35	430	<b>Tribeca</b>				
<b>LW200</b>					<b>2006-03 H4 2.5L MT</b>					2014-08	H6 3.6L		35	490
2003-02	L4 2.2L		78	600	<b>2006-03 H4 2.5L MT</b>					<b>WRX</b>				
2001	L4 2.2L		75	525	<b>2006-03 H4 2.5L MT</b>					2014-13	H4 2.5L	45	55D23L	0
<b>2006-03 H4 2.5L AT</b>					<b>2006-03 H4 2.5L MT</b>					<b>WRX STI</b>				
<b>2006-03 H4 2.5L MT</b>					<b>2006-03 H4 2.5L MT</b>					2014-13	H4 2.5L	45	55D23L	0
<b>2006-03 H4 2.5L MT</b>					<b>2006-03 H4 2.5L MT</b>					<b>XV Crosstrek</b>				
<b>2006-03 H4 2.5L MT</b>					<b>2006-03 H4 2.5L MT</b>					2014-13	H4 2.0L	45	55D23L	0

# Passenger Car & Light Truck

YEAR	ENGINE/ OPTIONS	FOOT NOTE	GROUP/ TYPE NO.	O.E. CCA (@0°F)	YEAR	ENGINE/ OPTIONS	FOOT NOTE	GROUP/ TYPE NO.	O.E. CCA (@0°F)	YEAR	ENGINE/ OPTIONS	FOOT NOTE	GROUP/ TYPE NO.	O.E. CCA (@0°F)
<b>SUZUKI</b>					<b>TOYOTA (Cont.)</b>					<b>TOYOTA (Cont.)</b>				
<b>Aerio</b>					<b>Avalon (Cont.)</b>					<b>MR2 Spyder</b>				
2007-04	L4 2.3L		24F	700	2004-03	V6 3.0L		24F	585	2005-00	L4 1.8L		51R	430
2003-02	L4 2.0L		24F	700	2004-03	V6 3.0L Optional		35	390	<b>Paseo</b>				
<b>Equator</b>					2002-95	V6 3.0L Canada & Optional		24F	585	1999-98	L4 1.5L		25	550
2012-09	L4 2.5L		24F	550	2002	V6 3.0L U.S.		35	390	1997	L4 1.5L		21	310
2012-09	V6 4.0L		24F	550	2001-95	V6 3.0L U.S.		35	360	1997	L4 1.5L Optional		25	360
<b>Esteem</b>					<b>Camry</b>					1996-95	L4 1.5L Optional		25	410
2002-99	L4 1.8L		26R	440	2014-12	L4 2.5L Gas		24F	585	<b>Pickup</b>				
2001	L4 1.6L		26R	540	2014-12	L4 2.5L Hybrid	45,54,60,69	S55D23R	355	1995	L4 2.4L Canada & Optional		24	585
2000-95	L4 1.6L		26R	440	2014-12	L4 2.5L Hybrid, w/Moon Roof	45,54,60,69	S65D26R	450	1995	L4 2.4L U.S.		25	360
<b>Forenza</b>					2014-07	V6 3.5L		24F	585	1995	V6 3.0L Canada & Optional		24	585
2008-04	L4 2.0L	11	86	610	2011-10	L4 2.5L		24F	585	1995	V6 3.0L U.S.		25	360
<b>Grand Vitara</b>					2011-07	L4 2.4L Hybrid	45,54,60,69	S65D26R	0	<b>Previa</b>				
2013-09	L4 2.4L		24F	700	2009-04	L4 2.4L Gas		24F	585	1997-95	L4 2.4L U.S.		35	360
2010-09	V6 3.2L		24F	700	2006-04	V6 3.0L		24F	585	1997	L4 2.4L Canada & Optional		24F	585
2008-06	V6 2.7L		24F	700	2006-04	V6 3.3L		24F	585	1996	L4 2.4L Canada or Optional		24F	585
2005-04	V6 2.5L		24F	700	2003-95	V6 3.0L Canada or Optional		24F	585	1995	L4 2.4L Canada & Optional		24F	585
2003-99	V6 2.5L		85	550	2003-02	L4 2.4L		35	360	<b>Prius</b>				
2001	V6 2.7L		24F	550	2003-02	L4 2.4L Optional		24F	585	2014-10	L4 1.8L Hybrid	45,54,69	S46B24R	325
<b>Kizashi</b>					2002	V6 3.0L U.S.		35	390	2009-04	L4 1.5L ex. Smart Key	45,47,54	S34B20R	270
2013-10	L4 2.4L		24F	700	2001-95	L4 2.2L Canada or Optional		24F	585	2009-04	L4 1.5L Smart Key	45,47,54	S46B24R	325
<b>Reno</b>					2001	V6 3.0L U.S.		35	360	2003-01	L4 1.5L	45,47,54	S34B20L	270
2008-05	L4 2.0L	11	86	610	<b>Celica</b>					<b>Prius C</b>				
<b>Samurai</b>					2005-00	L4 1.8L		35	310	2014-12	L4 1.5L Hybrid	45,54,69	S34B20R	270
1995	L4 1.3L		51	405	1999-95	L4 2.2L		35	360	2014-12	L4 1.5L Hybrid	45,54,69	S34B20R	270
<b>Sidekick</b>					1999-95	L4 2.2L Optional		35	420	<b>Prius V</b>				
1998-96	L4 1.6L		26R	390	1997-95	L4 1.8L		35	360	2014-12	L4 1.8L Hybrid	45,47,54	S46B24R	325
1998-96	L4 1.8L		85	550	1996-95	L4 1.8L Optional		35	420	<b>RAV4</b>				
1995	L4 1.6L		51	405	<b>Corolla</b>					2014-12	Electric	45	55D23L	355
<b>Swift</b>					2014-09	L4 1.8L		35	355	2014	L4 2.5L		35	356
2001-95	L4 1.3L		26R	440	2011	L4 2.4L		24F	585	2013-09	L4 2.5L		24F	585
<b>Swift+</b>					2010-09	L4 2.4L		24F	575	2012-06	V6 3.5L		24F	585
2009-04	L4 1.6L		86	550	2008-06	L4 1.8L		35	420	2008-04	L4 2.4L		24F	585
<b>SX4</b>					2005-04	L4 1.8L		35	310	2003-01	L4 2.0L		35	420
2013-07	L4 2.0L		24	700	2003-95	L4 1.8L		35	360	2000-96	L4 2.0L		35	360
<b>SX4 Crossover</b>					1997-95	L4 1.6L		35	310	<b>Sequoia</b>				
2012	L4 2.0L		24	700	<b>Echo</b>					2014-08	V8 5.7L		27F	710
<b>Verona</b>					2005-03	L4 1.5L		21	420	2012-10	V8 4.6L		27F	710
2006-04	L6 2.5L	11	34	700	2002-00	L4 1.5L U.S.		21	310	2009-04	V8 4.7L		27F	710
<b>Vitara</b>					2002	L4 1.5L Canada & Optional		25	360	2003-02	V8 4.7L Optional		27F	710
2004	V6 2.5L		85	600	2001	L4 1.5L Canada & Optional		25	420	2003-01	V8 4.7L		24F	585
2003-99	L4 2.0L		85	550	<b>FJ Cruiser</b>					2001	V8 4.7L Optional		27F	650
2002	L4 1.6L		26R	540	2014	V6 4.0L		24R	585	<b>Sienna</b>				
2001-99	L4 1.6L		85	550	2013-11	V6 4.0L		24F	585	2014-07	V6 3.5L		24F	585
<b>X-90</b>					2010-07	V6 4.0L		27F	710	2013-11	L4 2.7L		24F	585
1998-96	L4 1.6L		26R	440	<b>Highlander</b>					2006-04	V6 3.3L		24F	585
<b>XL-7</b>					2014-11	V6 3.5L Gas	45,54,60,69	24F	585	2003-02	V6 3.0L		35	360
2009-07	V6 3.6L		47	650	2014-11	V6 3.5L Hybrid	45,54,60,69	S55D23L	360	2003-02	V6 3.0L Optional		24F	585
2006-04	V6 2.7L		24F	700	2014-09	L4 2.7L		24F	585	2001-98	V6 3.0L		24F	585
2003-02	V6 2.7L		85	550	2010-08	V6 3.5L		24F	585	<b>Solara</b>				
<b>TOYOTA</b>					2010-06	V6 3.3L Hybrid		51R	435	2008-06	L4 2.4L		24F	585
<b>4Runner</b>					2007-06	V6 3.3L Gas		24F	585	2008-04	V6 3.3L		24F	585
2014-03	V6 4.0L		24F	585	2007-01	L4 2.4L		24F	585	2005-02	L4 2.4L		35	390
2010	L4 2.7L		24F	585	2005-04	V6 3.3L		24F	585	2003-01	V6 3.0L Canada & Optional		24F	585
2010	L4 2.7L Optional		27F	710	2003-01	V6 3.0L		24F	585	2002	V6 3.0L U.S.		35	390
2009-03	V6 4.0L Optional		27F	710	<b>Land Cruiser</b>					2001-99	L4 2.2L Canada & Optional		24F	585
2009-03	V8 4.7L		24F	585	2014-13	V8 5.7L		27F	710	2001-99	L4 2.2L U.S.		35	360
2009-03	V8 4.7L Optional		27F	710	2011-08	V8 5.7L		27F	710	2001	V6 3.0L U.S.		35	360
2009-03	V8 4.7L Optional		27F	710	2007-01	V8 4.7L		27F	710	2000-99	V6 3.0L Canada & Cold Climate		24F	585
2002-01	V6 3.4L		24F	585	2000-98	V8 4.7L		24F	575	<b>Supra</b>				
2000-96	L4 2.7L		24F	585	1997-95	L6 4.5L Canada & Optional		27F	625	1998-95	L6 3.0L AT		24F	585
2000-96	V6 3.4L		35	360	1997-95	L6 4.5L U.S.		24F	450	1998-95	L6 3.0L MT		24F	490
2000	V6 3.4L Optional		24F	585	<b>Matrix</b>					<b>T100</b>				
1997-96	V6 3.4L Optional		24F	585	2014-09	L4 1.8L		35	355	1998-95	L4 2.7L		24F	585
1995	L4 2.4L		25	360	2013-09	L4 2.4L		24F	575	1998-95	V6 3.4L		24F	585
1995	L4 2.4L Optional		24	585	2008-03	L4 1.8L		35	550	<b>Tacoma</b>				
1995	V6 3.0L		25	360	<b>MR2</b>					2014-09	V6 4.0L		27F	710
1995	V6 3.0L Optional		24	585	1995	L4 2.0L		35	360	2014-05	L4 2.7L		24F	585
<b>Avalon</b>					1995	L4 2.0L Optional		24F	490					
2014-13	L4 2.5L Hybrid	45,54,60,69	S55D23R	355	1995	L4 2.2L		24F	490					
2014-13	L4 2.5L Hybrid, w/Mayday System	45,54,60,69	S65D26R	450										
2014-05	V6 3.5L		24F	585										
2014-05	V6 3.5L Optional		35	390										

# Passenger Car & Light Truck

YEAR	ENGINE/ OPTIONS	FOOT NOTE	GROUP/ TYPE NO.	O.E. CCA (@0°F)	YEAR	ENGINE/ OPTIONS	FOOT NOTE	GROUP/ TYPE NO.	O.E. CCA (@0°F)	YEAR	ENGINE/ OPTIONS	FOOT NOTE	GROUP/ TYPE NO.	O.E. CCA (@0°F)	
<b>TOYOTA (Cont.)</b>					<b>VOLKSWAGEN (Cont.)</b>					<b>VOLKSWAGEN (Cont.)</b>					
<b>Tacoma (Cont.)</b>					<b>Beetle (Cont.)</b>					<b>EuroVan (Cont.)</b>					
2008-07	V6 4.0L		24F	585	2014	L4 2.0L PR-J0N	54,57,66,67,70	47	540	2002-00	V6 2.8L Auxiliary	62	27	570	
2006	V6 4.0L Cold Climate or Towing Package		27F	710	2014	L4 2.0L PR-J1L	54,57,66,67,70	48	480	2002-00	V6 2.8L Primary Battery	54	97R	575	
2006	V6 4.0L ex. Cold Climate & Towing Package		24F	585	2014	L4 2.0L PR-J2D	54,57,66,67,69,70	48	680	1999	V6 2.8L	62	42	460	
2005	V6 4.0L		24F	585	2013-12	L4 2.0L PR-J0N	54,57,66,67,70	47	540	1997-95	L5 2.4L Auxiliary	62	27	570	
2004	L4 2.4L		35	310	2013-12	L4 2.0L PR-J0T	54,57,66,67,70	48	680	1997-95	L5 2.4L Diesel	97R	42	460	
2004	L4 2.7L		35	310	2013-12	L4 2.0L PR-J1L	54,57,66,67,70	48	480	1996	V6 2.8L	62	27	570	
2004	V6 3.4L		24F	550	2013-12	L4 2.0L PR-J2D	54,57,66,67,69,70	48	680	1996	L5 2.5L Auxiliary Battery		97R	575	
2003-01	L4 2.4L Canada & Optional		24F	585	2013-12	L5 2.5L PR-J0T			680	1995	L5 2.5L		42	460	
2003-01	L4 2.4L U.S.		35	360	2013	L4 2.0L Diesel, PR-J0N	54,57,66,67,70	47	540	<b>Golf</b>					
2003-01	L4 2.7L Canada & Optional		24F	585	2013	L4 2.0L Diesel, PR-J0T			680	2014-10	L5 2.5L	54,66	47	540	
2003-01	L4 2.7L U.S.		35	360	2013	L4 2.0L Diesel, PR-J1D	54,57,66,67,70	48	640	2014-10	L5 2.5L Optional	54,66	48	640	
2003-01	V6 3.4L Canada & Optional		24F	585	2013	L4 2.0L Diesel, PR-J1L	54,57,66,67,70	48	480	2014	L4 2.0L	54,66	47	540	
2003-01	V6 3.4L U.S.		35	360	2013	L4 2.0L Diesel, PR-J2D	54,57,66,67,69,70	48	680	2014	L4 2.0L Optional	54,66	48	640	
2000-95	L4 2.4L		35	360	2012	L4 2.0L PR-J1D	54,57,66,67,69,70	48	680	2013-10	L4 2.0L Diesel	54,66	47	540	
2000-95	L4 2.4L Optional		24F	585	2012	L5 2.5L PR-J1D	54,57,66,67,69,70	48	640	2013-10	L4 2.0L Diesel, Optional	54,66	48	640	
2000-95	L4 2.7L		24F	585	2010-06	L5 2.5L	54,57,66,67,70	47	540	2013	L4 2.0L Gas	54,66	47	540	
2000-95	V6 3.4L		24F	585	2010-06	L5 2.5L Optional	54,57,66,67,70	48	640	2013	L4 2.0L Gas, Optional	54,66	48	640	
2000-95	V6 3.4L Optional		24F	585	2006	L4 1.9L Turbo Diesel	54,57,66,67,70	47	540	2012	L4 2.0L Gas	54,66	48	640	
<b>Tercel</b>					2006	L4 1.9L Turbo Diesel	54,57,66,67,70	47	540	2012	L4 2.0L Gas, Optional	54,66	47	540	
1999-97	L4 1.5L		21	310	2006	L4 1.9L Turbo Diesel	54,57,66,67,70	47	540	2006	L4 1.8L		47	480	
1999-97	L4 1.5L Optional		25	360	2006	L4 1.9L Turbo Diesel, Optional	54,57,66,67,70	48	640	2006	L4 1.9L Diesel		48	570	
1996-95	L4 1.5L		25	360	2005-04	L4 1.9L Turbo Diesel	54,57,66,67,70	47	540	2006	L4 2.0L ex. Turbo		47	480	
1996-95	L4 1.5L Optional		25	410	2005-03	L4 1.8L			480	2005-04	L4 1.9L Turbo Diesel		94R	640	
<b>Tundra</b>					2005-98	L4 2.0L			480	2005-03	L4 1.8L		47	570	
2014-10	V8 4.6L		24F	585	2005	L4 1.8L			480	2005-03	L4 2.0L		47	570	
2014-10	V8 4.6L Optional		27F	710	2005	L4 1.9L Turbo Diesel			480	2004	V6 3.2L	66	47	480	
2014-08	V6 4.0L Optional		27F	710	2004-98	L4 1.9L Turbo Diesel			480	2003	L4 1.9L Turbo Diesel		47	570	
2014-08	V8 5.7L Optional		27F	710	2004-03	L4 1.8L			640	2002-00	L4 1.8L		47	575	
2014-07	V6 4.0L		24F	585	2002-00	L4 1.8L			480	2002-00	L4 2.0L		47	575	
2014-07	V8 5.7L		24F	585	1999	L4 1.8L			480	2002-00	V6 2.8L		47	575	
2009-08	V8 4.7L Optional		27F	710	<b>Cabrio</b>					2002	L4 1.9L Turbo Diesel		47	575	
2009-07	V8 4.7L		24F	585	2002-00	L4 2.0L			575	2001	L4 1.9L Diesel		47	575	
2006-05	V8 4.7L ex. Cold Climate		24F	585	1999-98	L4 2.0L			575	2000	L4 1.9L Diesel		94R	620	
2006-02	V8 4.7L Cold Climate or Optional		27F	710	1997-95	L4 2.0L			460	1999-98	L4 2.0L		97R	575	
2006	V6 4.0L Cold Climate or Optional		27F	710	<b>CC</b>					1999-98	V6 2.8L		97R	575	
2006	V6 4.0L ex. Cold Climate		24F	585	2014-12	L4 2.0L	54,57,66,67,70	47	540	1999	L4 1.9L Diesel		98R	620	
2005	V6 4.0L		24F	585	2014-12	L4 2.0L Optional	54,57,66,67,70	48	640	1998	L4 1.8L		97R	575	
2005	V6 4.0L Optional		27F	710	2014-12	L4 2.0L Optional	54,57,66,67,69,70	48	680	1998	L4 1.9L Diesel		97R	575	
2004-02	V8 4.7L Primary Battery		24F	585	2014-12	L4 2.0L Optional	54,57,66,67,69,70	48	680	1997	L4 1.8L		42	460	
2004-00	V6 3.4L AT or Optional		24F	585	2014-12	L4 2.0L Optional	54,57,66,67,70	49	760	1997	L4 1.9L Diesel		98R	620	
2004-00	V6 3.4L MT		35	360	2014-12	V6 3.6L	54,57,66,67,70	47	540	1997	L4 2.0L		42	460	
2001-00	V8 4.7L		24F	585	2014-12	V6 3.6L Optional	54,57,66,67,70	48	640	1996-95	L4 1.8L		41	575	
2000	V8 4.7L Optional		27F	650	2014-12	V6 3.6L Optional	54,57,66,67,69,70	48	680	1996-95	L4 1.8L Optional		41	650	
<b>Venza</b>					2014-12	V6 3.6L Optional	54,57,66,67,70	49	760	1996-95	L4 2.0L		41	575	
2014-09	L4 2.7L		24F	585	2014-12	V6 3.6L Optional	54,57,66,67,70	49	760	1996-95	L4 2.0L Optional		41	650	
2014-09	V6 3.5L		24F	585	2013-12	L4 2.0L Optional			680	1996-95	V6 2.8L		41	575	
<b>Yaris</b>					2013-12	V6 3.6L Optional			680	1995	L4 1.9L Diesel		41	575	
2014-06	L4 1.5L	45	55D23L	360	2011-09	L4 2.0L	54	47	480	1995	L4 1.9L Diesel, Optional		41	650	
<b>VOLKSWAGEN</b>					2011-09	V6 3.6L	54	48	640	<b>Golf City</b>					
<b>Beetle</b>					<b>Corrado</b>					2010-07 L4 2.0L 66 47 540					
2014-13	L4 2.0L PR-J1D	54,57,66,67,70	48	640	1995	V6 2.8L		42	460	<b>GTI</b>					
2014-13	L5 2.5L PR-J1D	54,57,66,67,70	48	640	<b>Eos</b>					2014-11 L4 2.0L 54,66 47 540					
2014-12	L5 2.5L PR-J0N	54,57,66,67,70	47	540	2014-09	L4 2.0L Optional	54,57,66,67,69,70	48	680	2014-11	L4 2.0L Optional	54,66	48	570	
2014-12	L5 2.5L PR-J1L	54,57,66,67,70	48	480	2014-07	L4 2.0L	54,57,66,67,70	47	540	2010-09	L4 2.0L	66	48	570	
2014-12	L5 2.5L PR-J2D	54,57,66,67,69,70	48	680	2014-07	L4 2.0L Optional	54,57,66,67,70	48	640	2008-06	L4 2.0L	66	48	540	
2014	L4 2.0L Diesel, PR-J0N	54,57,66,67,70	47	540	2013-12	L4 2.0L Optional			480	<b>Jetta</b>					
2014	L4 2.0L Diesel, PR-J1D	54,57,66,67,70	48	640	2013-12	L4 2.0L Optional			680	2014-13	L4 1.4L	54,66	47	540	
2014	L4 2.0L Diesel, PR-J1L	54,57,66,67,70	48	480	2008-07	V6 3.2L	54,57,66,67,70	47	540	2014-13	L4 1.4L Optional	54,66	48	570	
2014	L4 2.0L Diesel, PR-J2D	54,57,66,67,69,70	48	680	2008-07	V6 3.2L Optional	54,57,66,67,70	48	640	2014-09	L4 2.0L Diesel	54,66	47	540	
<b>EuroVan</b>					<b>EuroVan</b>					2014-09 L4 2.0L Diesel, Optional 54,66 48 570					
2003	V6 2.8L		54	97R	575	2014-08	L4 2.0L Gas	54,66	47	540	2014-08	L4 2.0L Gas, Optional	54,66	48	570
										2014-06 L5 2.5L 54,66 47 540					

# Passenger Car & Light Truck

YEAR	ENGINE/ OPTIONS	FOOT NOTE	GROUP/ TYPE NO.	O.E. CCA (@0°F)	YEAR	ENGINE/ OPTIONS	FOOT NOTE	GROUP/ TYPE NO.	O.E. CCA (@0°F)	YEAR	ENGINE/ OPTIONS	FOOT NOTE	GROUP/ TYPE NO.	O.E. CCA (@0°F)
<b>VOLKSWAGEN (Cont.)</b>					<b>VOLKSWAGEN (Cont.)</b>					<b>VOLKSWAGEN (Cont.)</b>				
<b>Jetta (Cont.)</b>					<b>Passat (Cont.)</b>					<b>Toureg (Cont.)</b>				
2014-05	L5 2.5L Optional	54,66	48	570	2014-12	L5 2.5L	54,66	47	540	2005-04	V8 4.2L			
2014	L4 1.8L	54,66	47	540	2014-12	L5 2.5L Optional	54,66	48	640	2004	V10 4.9L Diesel	54,66	49	850
2014	L4 1.8L Optional	54,66	48	570	2014-12	L5 2.5L Optional	54,66	49	760	2004	V10 4.9L Diesel, Auxiliary	54,66	95R	950
2009-08	L4 2.0L Gas, Optional	54,66	94R	640	2014-12	V6 3.6L	54,66	47	540	<b>VOLVO</b>				
2009-05	L5 2.5L Optional	54,66	94R	640	2014-12	V6 3.6L Optional	54,66	48	640	<b>850</b>				
2009	L4 2.0L Diesel, Optional	54,66	94R	640	2014	L4 1.8L	54,66	47	540	1997-95	L5 2.3L		47	520
2007	L4 2.0L	54,66	47	540	2014	L4 1.8L Optional	54,66	48	640	1997-95	L5 2.4L		47	520
2007	L4 2.0L Optional	54,66	48	570	2014	L4 1.8L Optional	54,66	49	760	<b>940</b>				
2007	L4 2.0L Optional	54,66	94R	640	2010-08	L4 2.0L	66	47	480	1995	L4 2.3L		47	520
2006-98	L4 1.9L Diesel, Optional	54,66	94R	640	2010-08	V6 3.6L	66	48	640	<b>960</b>				
2006-05	L4 1.9L Diesel, Optional	54,66	48	570	2010-06	L4 2.0L Optional	66	48	640	1997-95	L6 2.9L		48	600
2006	L4 1.9L Diesel	54,66	47	540	2007	L4 2.0L	47	480	<b>C30</b>					
2006	L4 2.0L Turbo	54,66	47	540	2007	V6 3.6L	48	640	2013-07	L5 2.5L	54	91	590	
2006	L4 2.0L Turbo, Optional	54,66	48	570	2006	L4 2.0L	66	47	480	2013-07	L5 2.5L Optional	54	94R	700
2006	L4 2.0L Turbo, Optional	54,66	48	570	2006	V6 3.6L	66	48	640	2010-07	L5 2.4L	54	91	590
2006	L4 2.0L Turbo, Optional	54,66	94R	640	2005-98	V6 2.8L	66	48	540	2010-07	L5 2.4L Optional	54	94R	700
2005-98	L4 2.0L Optional	54,66	94R	640	2005	L4 1.8L ex. 4 Motion	54	49	740	<b>C70</b>				
2005-04	L4 1.8L Turbo, Optional	54,66	94R	640	2005	L4 2.0L	66	94R	640	2013-06	L5 2.5L	54	91	590
2005	L4 1.8L Early	54,66	47	520	2004-03	W8 4.0L		94R	640	2013-06	L5 2.5L Optional	54	94R	700
2005	L4 1.8L Late	54,66	47	540	2004	L4 1.8L ex. 4 Motion		48	570	2004-03	L5 2.3L Turbo		48	600
2005	L4 1.8L Optional	54,66	48	570	2004	L4 1.8L ex. 4 Motion	54	48	570	2004-03	L5 2.4L	54	48	600
2005	L4 1.9L Diesel, Early	54,66	47	520	2002	W8 4.0L ex. 4 Motion	54	48	570	2002-01	L5 2.3L	54	48	600
2005	L4 1.9L Diesel, Late	54,66	47	540	2000-98	L4 1.8L	48	48	570	2002	L5 2.4L Turbo	54	48	600
2005	L4 2.0L Early	54,66	47	520	1997-95	V6 2.8L	42	460	650	2001	L5 2.4L	54	48	600
2005	L4 2.0L Late	54,66	47	540	1997	L4 1.9L Diesel	98R	650		2000-98	L5 2.3L		47	520
2005	L4 2.0L Optional	54,66	48	570	1996-95	L4 2.0L	42	460		2000-98	L5 2.4L		47	520
2005	L5 2.5L Early	54,66	47	520	1996-95	L4 2.0L Optional	41	650		<b>S40</b>				
2005	L5 2.5L Late	54,66	47	540	1996	L4 1.9L Diesel	6	41	650	2011-05	L5 2.5L w/Premium Stereo	54	94R	700
2004-98	L4 1.9L Diesel	54,66	47	520	1996	V6 2.8L Optional	42	42	650	2011	L5 2.5L w/o Premium Stereo	54	91	590
2004-98	L4 2.0L	54,66	47	520	1995	L4 1.9L Diesel	42	42	460	2010-05	L5 2.4L	54	91	590
2004-98	V6 2.8L	54,66	47	520	1995	V6 2.8L Optional	41	650		2010-05	L5 2.4L w/Premium Stereo	54	94R	700
2004-98	V6 2.8L Optional	54,66	94R	640	<b>Passat CC</b>					2010-05	L5 2.5L	54	91	590
2004	L4 1.8L Turbo	54,66	47	520	2010-09	L4 2.0L	54,66	47	480	2004	L4 1.9L Early		48	600
2003-00	L4 1.8L	54,66	47	520	2010-09	V6 3.6L	54,66	48	640	2004	L4 1.9L Late	54	91	590
2003-00	L4 1.8L Optional	54,66	94R	640	<b>Phaeton</b>					2004	L4 1.9L Late, w/Premium Stereo	54	94R	700
2002-98	L4 1.9L Diesel, Optional	54,66	48	570	2006-04	V8 4.2L	54	49	740	2004	L5 2.4L Early	54	48	600
2002-98	L4 2.0L Optional	54,66	48	570	2006-04	W12 6.0L	54	49	740	2004	L5 2.4L Late	54	91	590
2002-98	V6 2.8L Optional	54,66	48	570	<b>R32</b>					2004	L5 2.4L Late, w/Premium Stereo	54	94R	700
2002-00	L4 1.8L Optional	54,66	48	570	2008	V6 3.2L	66	94R	640	2004	L5 2.4L Late, w/Premium Stereo	54	94R	700
2001	L4 1.8L Optional, Cold Climate	54,66	49	760	<b>Rabbit</b>					2004	L5 2.5L Early	54	48	600
2001	L4 1.9L Diesel, Optional, Cold Climate	54,66	49	760	2009-06	L5 2.5L	66	48	540	2004	L5 2.5L Late	54	91	590
2001	V6 2.8L Optional, Cold Climate	54,66	49	760	<b>Routan</b>					2004	L5 2.5L Late, w/Premium Stereo	54	94R	700
1999-98	L4 1.9L Diesel, Optional	54,66	97R	575	2012	V6 3.6L		94R	730	2003-00	L4 1.9L		48	600
1999-98	L4 2.0L Optional	54,66	97R	575	2011	V6 3.6L		94R	700	<b>S60</b>				
1999-98	V6 2.8L Optional	54,66	97R	575	2010-09	V6 3.8L		34	600	2014-12	L5 2.5L w/o Premium Stereo	54	48	600
1997	L4 1.9L Diesel		98R	620	2010-09	V6 4.0L		34	600	2014-12	L5 2.5L w/Premium Stereo	54	92	700
1997	L4 2.0L		42	460	<b>Tiguan</b>					2014-11	L6 3.0L w/o Premium Stereo	54	48	600
1997	V6 2.8L		42	460	2014-09	L4 2.0L	54,66	47	540	2014-11	L6 3.0L w/Premium Stereo	54	92	700
1996-95	L4 2.0L		41	575	2014-09	L4 2.0L Optional	54,66	48	640	2009-03	L5 2.5L	54	48	600
1996-95	L4 2.0L Optional		41	650	<b>Toureg</b>					2009-03	L5 2.5L Optional	54	49	800
1996-95	V6 2.8L		41	575	2014-11	V6 3.0L Diesel	54,66	48	640	2009-01	L5 2.4L	54	48	600
1996	L4 1.9L Diesel	6	41	575	2014-11	V6 3.0L Diesel, Optional	54,66	94R	760	2009-01	L5 2.4L Optional	54	49	800
1995	L4 1.8L		41	575	2014-11	V6 3.0L Hybrid	54,66	48	640	2004-01	L5 2.3L Turbo	54	48	600
1995	L4 1.9L Diesel		41	650	2014-11	V6 3.0L Hybrid, Optional	54,66	94R	760	2004-01	L5 2.3L Turbo, Optional	54	49	800
1995	V6 2.8L Optional		41	650	2014-11	V6 3.0L Hybrid, Optional	54,66	95R	850	<b>S70</b>				
<b>Jetta City</b>					2014-11	V6 3.6L	54,66	48	640	2000	L5 2.3L		48	600
2009-07	L4 2.0L	54	47	540	2014-11	V6 3.6L Optional	54,66	94R	760	2000	L5 2.4L		48	600
2009-07	L4 2.0L Optional	54	48	570	2014-07	V6 3.6L Optional	54,66	95R	850	1999-98	L5 2.3L		47	520
2009-07	L4 2.0L Optional	54	94R	640	2010-09	V6 3.0L Diesel	54,66	95R	850	1999-98	L5 2.4L		47	520
<b>Passat</b>					2010-07	V6 3.6L	54,66	49	760	1999	L5 2.3L From Chassis #491304		48	600
2014-12	L4 2.0L Diesel	54,66	47	540	2009-08	V8 4.2L	54	93	790	1999	L5 2.4L From Chassis #491304		48	600
2014-12	L4 2.0L Diesel, Optional	54,66	48	640	2008	V10 5.0L Diesel	54	93	740	<b>S80</b>				
2014-12	L4 2.0L Diesel, Optional	54,66	49	760	2007-06	V8 4.2L	54	93	740	2014-08	L6 3.0L w/o Premium Stereo	54	48	600
					2007	V10 5.0L	54	93	740					
					2007	V8 4.2L	54,66	93	740					
					2006-05	V10 5.0L	54,66	49	850					
					2006-04	V6 3.2L	54	94R	640					

# Passenger Car & Light Truck

YEAR	ENGINE/ OPTIONS	FOOT NOTE	GROUP/ TYPE NO.	O.E. CCA (@0°F)	YEAR	ENGINE/ OPTIONS	FOOT NOTE	GROUP/ TYPE NO.	O.E. CCA (@0°F)
<b>VOLVO (Cont.)</b>					<b>WORKHORSE</b>				
<b>S80 (Cont.)</b>					<b>FasTrack FT1061</b>				
2014-08	L6 3.0L w/Premium Stereo	54	92	700	2005-04	V8 4.8L		78	690
2014-07	L6 3.2L w/o Premium Stereo	54	48	600	2004-02	V8 5.7L		78	690
2014-07	L6 3.2L w/Premium Stereo	54	92	700	2001-00	V8 5.7L		78	690
2010-07	V8 4.4L Optional	54	93	800	<b>FasTrack FT1260</b>				
2010	V8 4.4L w/o Premium Stereo	54	48	600	2001-00	V8 5.7L		78	690
2010	V8 4.4L w/Premium Stereo	54	92	700	<b>FasTrack FT1261</b>				
2009-07	V8 4.4L	54	48	600	2005-04	L4 3.9L		78	690
2009-07	V8 4.4L Optional	54	92	700	2005-02	V8 5.7L		78	690
2006-04	L5 2.5L	54	48	600	2005	V8 4.8L		78	690
2006-04	L5 2.5L Optional	54	49	800	<b>FasTrack FT1460</b>				
2005-99	L6 2.9L	54	48	600	2002-00	V8 5.7L		78	690
2005-99	L6 2.9L Optional	54	49	800	<b>FasTrack FT1461</b>				
2001-99	L6 2.8L	54	48	600	2005-04	L4 3.9L		78	690
2001-99	L6 2.8L Optional	54	49	800	2005-04	V8 4.8L		78	690
<b>S90</b>					2005-04	V8 6.0L		78	690
1998-97	L6 2.9L		48	600	2005-02	V8 5.7L		78	690
<b>V40</b>					<b>FasTrack FT1600</b>				
2004-00	L4 1.9L	54	48	600	2001-00	V8 5.7L		78	690
<b>V50</b>					<b>FasTrack FT1601</b>				
2011-05	L5 2.5L w/o Premium Stereo	54	91	590	2005-04	L4 3.9L		78	690
2011-05	L5 2.5L w/Premium Stereo	54	94R	700	2005-04	V8 4.8L		78	690
2010-05	L5 2.4L w/o Premium Stereo	54	91	590	2005-02	V8 5.7L	2	78	600
2010-05	L5 2.4L w/Premium Stereo	54	94R	700	2004-02	V8 5.7L		78	690
<b>V70</b>					<b>FasTrack FT1800</b>				
2010-08	L6 3.2L w/o Premium Stereo	54	48	600	2001-00	V8 5.7L		78	690
2010-08	L6 3.2L w/Premium Stereo	54	92	700	<b>FasTrack FT1801</b>				
2007-98	L5 2.4L	54	47	520	2005-04	V8 6.0L		78	690
2007-98	L5 2.4L Optional	54	48	600	2005-02	V8 6.5L	2	78	600
2007-03	L5 2.5L	54	47	520	2004-02	V8 5.7L		78	690
2007-03	L5 2.5L Optional	54	48	600	<b>FasTrack FT1802</b>				
2007-03	L5 2.5L Optional	54	49	800	2003-02	V8 5.7L		78	690
2007-02	L5 2.4L Optional	54	49	800	2003-02	V8 6.5L	2	78	600
2004-98	L5 2.3L	54	47	520	<b>FasTrack FT931</b>				
2004-98	L5 2.3L Optional	54	48	600	2003-02	V6 4.3L		78	690
2004-02	L5 2.3L Optional	54	49	800	<b>P30</b>				
<b>V90</b>					2005-00	V8 5.7L		78	690
1998-97	L6 2.9L		48	600					
<b>XC60</b>									
2014-10	L6 3.0L w/o Premium Stereo	54	48	600					
2014-10	L6 3.0L w/Premium Stereo	54	92	700					
2014-10	L6 3.2L w/o Premium Stereo	54	48	600					
2014-10	L6 3.2L w/Premium Stereo	54	92	700					
<b>XC70</b>									
2014-09	L6 3.0L w/o Premium Stereo	54	48	600					
2014-09	L6 3.0L w/Premium Stereo	54	92	700					
2014-08	L6 3.2L w/o Premium Stereo	54	48	600					
2014-08	L6 3.2L w/Premium Stereo	54	92	700					
2007-03	L5 2.5L	54	47	520					
2007-03	L5 2.5L Optional	54	48	600					
2007-03	L5 2.5L Optional	54	49	800					
<b>XC90</b>									
2014-07	L6 3.2L	54	48	600					
2014-07	L6 3.2L Optional	54	49	760					
2011-05	V8 4.4L	54	48	600					
2011-05	V8 4.4L Optional	54	49	760					
2006-03	L5 2.5L	54	48	600					
2006-03	L5 2.5L Optional	54	49	760					
2005-03	L6 2.9L	54	48	600					
2005-03	L6 2.9L Optional	54	49	760					

YEAR	ENGINE/ OPTIONS	FOOT NOTE	GROUP/ TYPE NO.	O.E. CCA (@0°F)	YEAR	ENGINE/ OPTIONS	FOOT NOTE	GROUP/ TYPE NO.	O.E. CCA (@0°F)	YEAR	ENGINE/ OPTIONS	FOOT NOTE	GROUP/ TYPE NO.	O.E. CCA (@0°F)
<b>ADVANCE MIXER</b>					<b>CHEVROLET (Cont.)</b>					<b>CHEVROLET (Cont.)</b>				
<b>Class 8 Cement Mixer</b>					<b>Medium/Heavy Truck (Cont.)</b>					<b>Medium/Heavy Truck (Cont.)</b>				
<b>61000</b>					<b>B7 (Cont.)</b>					<b>C6500 Kodiak (Cont.)</b>				
2001-95	ALL	3	31T	650	2002-95	6.0L, 6.5L, 7.0L, 7.4L, 8.1L		78	600	1998-97	6.6L		31T	750
<b>6600</b>					2002-01	8.1L Optional	2	31T	700		7.0L Optional		31T	625
2002-95	ALL	3	31T	650	2000-99	7.4L Optional		31T	625		7.0L Optional		78	770
<b>6800</b>						7.4L Optional		78	770	<b>C70 Kodiak</b>				
2001-95	ALL	3	31T	650	1998-95	6.0L Optional		31T	625	1996-95	6.0L Optional		31T	625
<b>Cement Dump</b>						6.0L Optional		78	770		6.0L Optional		78	770
2001-97	ALL	3	31T	650		7.0L Optional		31T	625		6.0L, 7.0L		78	600
<b>Federal Bridge</b>						7.0L Optional		78	770		6.6L Optional		31T	900
2014-02	ALL	3	31T	650	1998	6.6L Optional		31T	750		7.0L Optional		31T	625
<b>Great Lakes 5 A</b>					1997-95	6.6L		31T	750	1996	6.6L		31T	625
2014-02	ALL	3	31T	650	<b>C3500HD</b>						6.6L Optional		31T	750
<b>Michigan 6 Axle</b>					2002-99	6.5L Diesel & Optional	2	78	690	1995	6.6L		31T	750
2014-02	ALL	3	31T	650	2002-97	6.5L Diesel	2	78	600	<b>C7500 Kodiak</b>				
<b>Standard 3 Axle</b>					2002-01	8.1L		78	600	2009-99	7.2L Optional	2,3	31T	750
2014-02	ALL	3	31T	650		8.1L Optional		78	690		7.2L, 7.8L	2,3	31T	700
<b>Standard 4 Axle</b>					2000-99	7.4L Optional		78	690	2009-97	6.0L, 7.0L, 7.4L, 8.1L		78	600
2014-02	ALL	3	31T	650		7.4L Police & Optional		78	770	2009-03	7.8L Optional	2,3	31T	750
<b>AUTOCAR</b>						7.4L Primary Battery		78	600	2009-01	8.1L Optional	2	31T	700
<b>Class 8 Refuse</b>					1998-95	5.7L, 7.4L		78	600	2009	7.8L Optional	2	48	730
<b>E3 HYBRID</b>					1996-95	6.5L Diesel	2	78	770		8.1L Optional		48	615
2014-11	ALL	3	31T	660	<b>C4500 Kodiak</b>						8.1L Optional		48	730
<b>Xpeditor</b>					2009-03	6.6L	2,3	31T	700	2007	8.1L		48	315
2014-02	ALL	3	31T	660		6.6L Optional	2,3	31T	750	2000-99	7.4L Optional		31T	625
<b>Class 8 Truck</b>						8.1L		78	600		7.4L Optional		78	770
<b>Autocar</b>						8.1L Optional	2	31T	700	1998-97	6.0L Optional		31T	625
1997-95	ALL	4	31T	550	2009	8.1L Optional		78	750		6.0L Optional		78	770
	10.0L Optional	4	31T	625		8.1L		48	615		6.6L		31T	625
	10.0L Optional	4	31T	750	2007	8.1L		48	730		6.6L Optional		31T	900
	10.8L Optional	4	31T	625	2006	8.1L		78	800		7.0L Optional		31T	625
	10.8L Optional	4	31T	750	<b>C5500 Kodiak</b>						7.0L Optional		78	770
	11.1L Optional	4	31T	625	2009-07	6.6L Diesel, Optional	2	48	730	<b>T6500</b>				
	11.1L Optional	4	31T	750	2009-03	ALL		78	600	2009-04	7.8L	2,3	31T	700
	12.1L Optional	4	31T	625		6.6L Diesel	2,3	31T	700		7.8L Optional	2,3	31T	750
	12.1L Optional	4	31T	750		6.6L Diesel, Optional	2,3	31T	750	2009	7.8L Optional	2	48	730
	12.7L Optional	4	31T	625		8.1L Optional	2	31T	700	2002-99	7.8L Optional	2,3	31T	750
	12.7L Optional	4	31T	750	2009	8.1L Optional		78	750	2002-98	7.2L Optional	2,3	31T	750
	14.0L Optional	4	31T	625		8.1L Optional		48	615		7.2L, 7.8L	2,3	31T	700
	14.0L Optional	4	31T	750	2007	8.1L Optional		48	730	1998-97	6.0L		78	600
	14.6L Optional	4	31T	625	2006	6.6L Diesel, Optional	2	79	800		6.0L Optional		31T	625
	14.6L Optional	4	31T	750		8.1L Optional		79	800		6.0L Optional		78	770
<b>BLUE BIRD</b>					2005-03	6.6L Diesel, Optional	2	78	770	<b>T7500</b>				
<b>School Bus Chassis</b>					<b>C60 Kodiak</b>					<b>T6500</b>				
<b>All American FE</b>					1996-95	6.0L Optional		31T	625	2009-04	7.8L	2,3	31T	700
2014-00	ALL		31T	700		6.0L Optional		78	770		7.8L Optional	2,3	31T	750
<b>All American RE</b>						6.0L, 7.0L		78	600	2009	7.8L Optional	2	48	730
2014-99	ALL		31T	700		6.6L Optional		31T	900	2002-99	7.8L Optional	2,3	31T	750
<b>CATERPILLAR</b>						7.0L Optional		31T	625	2002-98	7.2L Optional	2,3	31T	750
<b>Class 8 Truck</b>						7.0L Optional		78	770		7.2L, 7.8L	2,3	31T	700
<b>CT 660</b>					1996	6.6L		31T	625	1998-97	6.0L		78	600
2014-11	ALL	4	31T	650		6.6L Optional		31T	750		6.0L Optional		31T	625
<b>CT 680</b>					1995	6.6L		31T	625		6.0L Optional		78	770
2014-13	ALL	4	31T	650		6.6L Optional		31T	750		6.6L		31T	625
<b>CHEVROLET</b>						6.6L		31T	750		6.6L Optional		31T	750
<b>Class 8 Truck</b>					<b>C6500 Kodiak</b>					<b>W3500 Tiltmaster</b>				
<b>C8500 Kodiak</b>					2009-99	7.2L Optional	2,3	31T	750	2008-95	4.8L, 5.7L, 6.0L		78	600
2009-03	7.2L, 7.8L	2,3	31T	700		7.2L, 7.8L	2,3	31T	700	2008-05	5.2L	2,3	31T	700
	7.8L Optional	2,3	31T	750	2009-97	6.0L, 7.0L, 7.4L, 8.1L		78	600		5.2L Optional	2,3	31T	750
	8.1L		78	600		8.1L		78	600		5.2L Optional	2	48	700
	8.1L Optional	2	31T	700	2009-03	7.8L Optional	2,3	31T	750		6.0L Optional	2	48	700
	8.1L Optional		78	750	2009-01	8.1L Optional	2	31T	700	2008-04	6.0L Optional	2	31T	700
2008-03	7.2L Optional	2,3	31T	750		8.1L Optional		78	750		6.0L Optional		78	750
<b>Medium/Heavy Truck</b>					2009	7.8L	2	48	730	2004-99	4.8L Optional	2	31T	700
<b>B7</b>						8.1L		48	615		4.8L Optional		78	750
2002-98	6.6L, 7.2L 7.2L Optional		31T	625	2007	8.1L Optional		48	615	2003-95	5.7L Optional	2	31T	700
			31T	750	2000-99	7.4L Optional		31T	625		5.7L Optional		78	750
						7.4L Optional		78	770	1998-95	3.9L	2	31T	750
					1998-97	6.0L Optional		31T	625	<b>W4500 Tiltmaster</b>				
						6.0L Optional		78	750	2010-98	4.8L, 5.7L, 6.0L		78	600
										2010-05	5.2L	2,3	31T	700

# Trucks

YEAR	ENGINE/ OPTIONS	FOOT NOTE	GROUP/ TYPE NO.	O.E. CCA (@0°F)	YEAR	ENGINE/ OPTIONS	FOOT NOTE	GROUP/ TYPE NO.	O.E. CCA (@0°F)	YEAR	ENGINE/ OPTIONS	FOOT NOTE	GROUP/ TYPE NO.	O.E. CCA (@0°F)
<b>CHEVROLET (Cont.)</b>					<b>FORD (Cont.)</b>					<b>FORD (Cont.)</b>				
<b>Medium/Heavy Truck (Cont.)</b>					<b>Class 8 Truck (Cont.)</b>					<b>Class 8 Truck (Cont.)</b>				
<b>W4500 Tiltmaster (Cont.)</b>					<b>Aeromax (Cont.)</b>					<b>LTL9000 (Cont.)</b>				
2010-05	5.2L Optional 6.0L Optional	2,3 2	31T 31T	750 750	1997	10.5L Optional 10.8L Optional	2 2	31T 31T	900 900	1996-95	14.6L Optional 10.0L Optional	2 2	31T 31T	900 900
2010-03	6.0L Optional 6.0L Optional	2	31T 78	700 750		12.0L Optional 12.7L Optional	2 2	31T 31T	900 900	<b>LTLA9000</b>				
2004-99	4.8L Optional 4.8L Optional	2	31T 78	700 750	<b>Cargo</b>					1996-95	ALL 10.8L Optional	3 2	31T 31T	655 900
2003-98	5.7L Optional 5.7L Optional	2	31T 78	700 750	1997-95	ALL 7.0L Optional		62 64	380 535		12.7L Optional 14.6L Optional	2 2	31T 31T	900 900
1998	3.9L	2	31T	750	<b>L9000</b>					1995	10.0L Optional	2	31T	900
<b>W5500 Tiltmaster</b>					1996-95	ALL 10.3L Optional 11.1L Optional 14.6L Optional	3 2 2 2	31T 31T 31T 31T	625 900 900 900	<b>LTL9000 (Cont.)</b>				
2009-05	5.2L 5.2L Optional	2,3 2,3	31T 31T	700 750	<b>LA9000</b>					1996-95	ALL 10.8L Optional 11.1L Optional 12.7L Optional 14.6L Optional	3 2 2 2	31T 31T 31T 31T	655 900 900 900
2004-00	4.8L 4.8L Optional 4.8L Optional		78 31T 78	600 700 750	<b>LL9000</b>					1995	ALL	2	31T	900
<b>W5500HD Tiltmaster</b>					1996-95	ALL 11.1L Optional 14.6L Optional	3 2 2	31T 31T 31T	655 900 900	<b>LTS8000</b>				
2009-05	5.2L 5.2L Optional	2,3 2,3	31T 31T	700 750	<b>LLA9000</b>					1995	ALL	2	64	535
2004	4.8L 4.8L Optional 4.8L Optional		78 31T 78	600 700 750	1996-95	ALL 10.8L Optional 14.6L Optional	3 2 2	31T 31T 31T	655 900 900	<b>LTS9000</b>				
<b>CRANE CARRIER</b>					1996-95	ALL 10.8L Optional 11.1L Optional 14.6L Optional 10.0L Optional	3 2 2 2	31T 31T 31T 31T	655 900 900 900	<b>LTS9000</b>				
<b>Class 8 Refuse</b>					1995	10.0L Optional	2	31T	900	<b>Medium Duty</b>				
<b>COE2 CHASSIS HYBRID</b>					<b>LLS9000</b>					<b>LN</b>				
2014-13	ALL	2	31T	925	1996-95	ALL 10.8L Optional 11.1L Optional 14.6L Optional 10.0L Optional	3 2 2 2	31T 31T 31T 31T	655 900 900 900	<b>LN</b>				
<b>LCF Chassis</b>					<b>LN9000</b>					<b>Medium/Heavy Truck</b>				
2007-04	ALL	2	31T	925	1996-95	ALL 10.8L Optional 11.1L Optional 14.6L Optional	3 2 2 2	31T 31T 31T 31T	655 900 900 900	<b>CF7000</b>				
<b>LDT 2 Chassis</b>					<b>LN8000</b>					<b>CF8000</b>				
2014-04	ALL	2	31T	925	1996-95	ALL 14.6L Optional	2 2	64 31T	535 900	<b>CF7000</b>				
<b>LET 2 Chassis</b>					<b>LNT8000</b>					<b>CF8000</b>				
2014-04	ALL	2	31T	925	1996-95	ALL	2	64	535	<b>CF8000</b>				
<b>NYC Model</b>					<b>LNT9000</b>					<b>CF8000</b>				
1996-95	ALL	2	31T	925	1996-95	ALL 10.8L Optional 10.0L Optional	3 2 2	31T 31T 31T	655 900 900	<b>CF8000</b>				
<b>Class 8 Truck</b>					<b>LNT9000</b>					<b>F650</b>				
<b>COE2 CHASSIS</b>					<b>LNT9000</b>					<b>F650</b>				
2014-04	ALL	2	31T	925	1996-95	ALL 10.8L Optional 10.0L Optional	3 2 2	31T 31T 31T	655 900 900	<b>F650</b>				
<b>DIAMOND REO</b>					<b>Louisville</b>					<b>F650</b>				
<b>Class 8 Truck</b>					<b>Louisville</b>					<b>F650</b>				
<b>12064DD</b>					<b>Louisville</b>					<b>F650</b>				
1997-95	ALL	3	31T	700	1997-96	ALL 11.1L Optional 12.7L Optional 10.8L Optional	2 2 2 2	31T 31T 31T 31T	655 900 900 900	<b>F650</b>				
<b>C11664D</b>					<b>LS8000</b>					<b>F650</b>				
1997-95	ALL	3	31T	700	1997	10.8L Optional	2	31T	900	<b>F650</b>				
<b>E-ONE</b>					<b>LS9000</b>					<b>F650</b>				
<b>Class 8 Fire/Crash</b>					<b>LS9000</b>					<b>F650</b>				
<b>Crash Titan</b>					<b>LS9000</b>					<b>F650</b>				
2001-95	ALL	4	31T	650	1995	ALL	2	64	535	<b>F650</b>				
<b>Cyclone</b>					<b>LS9000</b>					<b>F650</b>				
1996-95	ALL	4	31T	650	1996-95	ALL 11.1L Optional 14.6L Optional	3 2 2	31T 31T 31T	625 900 900	<b>F650</b>				
<b>Cyclone II</b>					<b>LT8000</b>					<b>F650</b>				
2014-96	ALL	4	31T	650	1996-95	ALL	2	64	535	<b>F650</b>				
<b>Hurricane</b>					<b>LT9000</b>					<b>F650</b>				
2014-95	ALL	4	31T	650	1996-95	ALL 10.8L Optional 11.1L Optional 12.7L Optional 14.6L Optional 10.0L Optional	3 2 2 2 2	31T 31T 31T 31T 31T	655 900 900 900 900	<b>F650</b>				
<b>Hush</b>					<b>LTA9000</b>					<b>F650</b>				
2014-02	ALL	4	31T	650	1996-95	ALL 10.8L Optional 11.1L Optional 12.7L Optional 14.6L Optional 10.0L Optional	3 2 2 2 2	31T 31T 31T 31T 31T	655 900 900 900 900	<b>F650</b>				
<b>Protector</b>					<b>LTA9000</b>					<b>F650</b>				
1996-95	ALL	4	31T	650	1996-95	ALL 10.8L Optional 11.1L Optional 12.7L Optional 14.6L Optional 10.0L Optional	3 2 2 2 2	31T 31T 31T 31T 31T	655 900 900 900 900	<b>F650</b>				
<b>Quest</b>					<b>LTA9000</b>					<b>F650</b>				
2014-07	ALL	4	31T	650	1995	ALL	2	64	535	<b>F650</b>				
<b>Typhoon</b>					<b>LTA9000</b>					<b>F650</b>				
2014-02	ALL	4	31T	650	1996-95	ALL 10.8L Optional 11.1L Optional 12.7L Optional 14.6L Optional 10.0L Optional	3 2 2 2 2	31T 31T 31T 31T 31T	655 900 900 900 900	<b>F650</b>				
<b>FORD</b>					<b>LTL9000</b>					<b>F650</b>				
<b>Class 8 Truck</b>					<b>LTL9000</b>					<b>F650</b>				
<b>Aeromax</b>					<b>LTL9000</b>					<b>F650</b>				
1997-96	ALL 11.1L Optional	2 2	31T 31T	655 900	1996-95	ALL 10.8L Optional	3 2	31T 31T	655 900	<b>F650</b>				
1997	10.3L Optional	2	31T	900	1996-95	ALL 10.8L Optional	3 2	31T 31T	655 900	<b>F650</b>				

# Trucks

YEAR	ENGINE/ OPTIONS	FOOT NOTE	GROUP/ TYPE NO.	O.E. CCA (@0°F)	YEAR	ENGINE/ OPTIONS	FOOT NOTE	GROUP/ TYPE NO.	O.E. CCA (@0°F)	YEAR	ENGINE/ OPTIONS	FOOT NOTE	GROUP/ TYPE NO.	O.E. CCA (@0°F)
<b>FORETRAVEL</b>					<b>FREIGHTLINER (Cont.)</b>					<b>FREIGHTLINER (Cont.)</b>				
Motor Home Chassis					Class 8 Truck (Cont.)					Motor Home Chassis				
<b>IH</b>					<b>MB80</b>					<b>FRED</b>				
2014-13	ALL		31T	925	1996-95	ALL	3	31T	750	2014-13	ALL	3	31T	750
<b>NIMBUS</b>					<b>Severe-Duty FLD</b>					<b>MC CHASSIS</b>				
2014-13	ALL		31T	925	2009-03	ALL	4	31T	750	2014-06	ALL	3	31T	750
<b>PHENIX</b>					<b>Medium Duty</b>					<b>SL CHASSIS</b>				
2014-13	ALL		31T	925	<b>Cargo</b>					2014-13	ALL	3	31T	750
<b>FREIGHTLINER</b>					2003-99 ALL 4 31T 750					2014-00 ALL 4 31T 750				
Class 8 Truck					Medium/Heavy Truck					School Bus Chassis				
<b>112</b>					<b>108SD</b>					<b>C2</b>				
1996-95	ALL	3,4	31T	750	2014-12	ALL	3,4	31T	750	2014-04	ALL	3	31T	750
<b>112SD</b>					<b>114SD</b>					<b>Shuttle Bus Chassis</b>				
1996-95	ALL	3,4	31T	750	2014-12	ALL	3,4	31T	750	<b>MB65</b>				
<b>120</b>					<b>122SD</b>					2014-10 ALL 3 31T 750				
1996-95	ALL	3,4	31T	750	2014-13	ALL	3,4	31T	750	<b>XB CHASSIS</b>				
<b>120SD</b>					<b>Argosy</b>					2014-00 ALL 4 31T 750				
1996-95	ALL	3,4	31T	750	2014-99	ALL	4	31T	750	<b>GILLIG</b>				
<b>132</b>					<b>Business Class M2</b>					<b>Transit Bus Chassis</b>				
1996-95	ALL	3	31T	750	2014-04	ALL	4	31T	750	<b>LF Hybrid</b>				
<b>Argosy</b>					<b>Cascadia</b>					2014-13 ALL 31T 1150				
2006-97	ALL	4	31T	750	2012-09	ALL	4	31T	750	<b>Low Floor</b>				
<b>Cargo</b>					<b>Century Class</b>					2014-98 ALL 31T 1150				
2014-03	ALL	4	31T	750	2011-96	ALL	4	31T	750	<b>GMC</b>				
<b>Cascadia</b>					<b>Classic</b>					Class 8 Truck				
2014-07	ALL	4	31T	750	2009-01	ALL	4	31T	750	<b>C8500 Topkick</b>				
<b>Century</b>					<b>Classic XL</b>					2009-03 7.2L, 7.8L 2,3 31T 700				
2011-03	ALL	4	31T	750	2009-01	ALL	4	31T	750	7.8L Optional 2,3 31T 750				
<b>Century 112</b>					<b>Columbia</b>					8.1L 78 600				
1996	ALL	3	31T	750	2011-00	ALL	4	31T	750	8.1L Optional 2 31T 700				
<b>Century 120</b>					<b>Condor</b>					8.1L Optional 78 750				
1996	ALL	3	31T	750	2007-01	ALL	4	31T	750	2008-03 7.2L Optional 2,3 31T 750				
<b>Classic</b>					<b>Coronado</b>					Medium/Heavy Truck				
2009-03	ALL	4	31T	750	2012-02	ALL	4	31T	750	<b>B7</b>				
<b>COE</b>					<b>FC70</b>					2002-98 6.6L, 7.2L 31T 625				
1996-95	ALL	3	31T	750	2004-99	ALL	3	31T	750	7.2L Optional 31T 750				
<b>Columbia</b>					<b>FC80</b>					2002-95 6.0L, 6.5L, 7.0L, 7.4L, 8.1L 78 600				
2011-03	ALL	4	31T	750	2007-99	ALL	3	31T	750	2002-01 8.1L Optional 31T 625				
<b>Condor</b>					<b>FL106</b>					8.1L Optional 78 770				
2005-03	ALL	4	31T	750	2003-95	ALL	3	31T	750	2000-99 7.4L Optional 31T 625				
<b>Coronado</b>					<b>FL112</b>					1998-95 6.0L Optional 31T 625				
2014-03	ALL	4	31T	750	2003-96	ALL	3	31T	750	6.0L Optional 78 770				
<b>Coronado SD</b>					<b>FL50</b>					7.0L Optional 31T 625				
2014-10	ALL	4	31T	750	2005-95	ALL	3	31T	750	7.0L Optional 78 770				
<b>Evolution</b>					<b>FL60</b>					1998 6.6L Optional 31T 750				
2014-13	ALL	4	31T	750	2004-95	ALL	3	31T	750	1997-95 6.6L 31T 750				
<b>Fire Truck</b>					<b>FL70</b>					<b>C3500HD</b>				
2014-99	ALL	4	31T	750	2005-95	ALL	3	31T	750	2002-99 6.5L Diesel & Optional 2 78 690				
<b>FL106</b>					<b>FL80</b>					2002-97 6.5L Diesel 2 78 600				
2008-95	ALL	3	31T	750	2005-95	ALL	3	31T	750	2002-01 8.1L 78 600				
<b>FL112</b>					<b>FS65</b>					8.1L Optional 78 690				
2008-95	ALL	3	31T	750	2006-96	ALL	3	31T	750	2000-99 7.4L Optional 78 690				
<b>FL70</b>					<b>M2 106</b>					7.4L Primary Battery 78 600				
2006-98	ALL	3	31T	750	2014-03	ALL	4	31T	750	1998-95 5.7L, 7.4L 78 600				
<b>FL80</b>					<b>M2 112</b>					1996-95 6.5L Diesel 2 78 770				
2003-95	ALL	3	31T	750	2014-09	ALL	4	31T	750	<b>C4500 Topkick</b>				
<b>FL90</b>					<b>M2 HYBRID</b>					2009-03 6.6L 2,3 31T 700				
1996-95	ALL	3	31T	750	2014-09	ALL	4	31T	750	6.6L Optional 2,3 31T 750				
<b>FLD SD</b>					<b>M2e HYBRID</b>					8.1L 78 600				
2009-07	ALL	4	31T	750	2014-08	ALL	4	31T	750	8.1L Optional 2 31T 700				
<b>FLD112 REV</b>					<b>MT35</b>					8.1L Optional 78 750				
1996-95	ALL	4	31T	750	2014-97	ALL	3	31T	750	2009 8.1L Optional 48 615				
<b>FLD120</b>					<b>MT45</b>					<b>C5500 Topkick</b>				
1996-95	ALL	3	31T	750	2014-98	ALL	3	31T	750	2009-03 6.6L 2,3 31T 750				
<b>FLD120SD</b>					<b>MT55</b>					6.6L Optional 2,3 31T 750				
1996	ALL	3	31T	750	2014-99	ALL	3	31T	750	8.1L 78 600				
<b>M2</b>					<b>XC</b>					8.1L Optional 2 31T 700				
2014-03	ALL	4	31T	750	2005-02	ALL	4	31T	750	8.1L Optional 78 750				
										2009 6.6L Diesel 2 48 730				

# Trucks

YEAR	ENGINE/ OPTIONS	FOOT NOTE	GROUP/ TYPE NO.	O.E. CCA (@0°F)	YEAR	ENGINE/ OPTIONS	FOOT NOTE	GROUP/ TYPE NO.	O.E. CCA (@0°F)	YEAR	ENGINE/ OPTIONS	FOOT NOTE	GROUP/ TYPE NO.	O.E. CCA (@0°F)
<b>GMC (Cont.)</b>					<b>GMC (Cont.)</b>					<b>GMC (Cont.)</b>				
Medium/Heavy Truck (Cont.)					Medium/Heavy Truck (Cont.)					Medium/Heavy Truck (Cont.)				
<b>C5500 Topkick (Cont.)</b>					<b>T6500 (Cont.)</b>					<b>W5500HD Forward (Cont.)</b>				
2009	8.1L			48 615	1998-97	6.0L			78 600	2004	4.8L Optional		78	750
<b>C6000 Topkick</b>					6.0L Optional					<b>HINO</b>				
1996-95	6.0L Optional		31T	625	6.0L Optional					Medium/Heavy Truck				
	6.0L Optional		78	770	6.6L Optional					<b>145</b>				
	6.0L, 7.0L		78	600	6.6L Optional					2010-05 ALL				
	6.6L Optional		31T	900	6.6L Optional					2				
	7.0L Optional		31T	625	6.6L Optional					<b>155</b>				
	7.0L Optional		78	770	6.6L Optional					2014-13 ALL				
1996	6.6L		31T	625	6.6L Optional					2				
	6.6L Optional		31T	750	6.6L Optional					<b>165</b>				
1995	6.6L		31T	750	6.6L Optional					2010-05 ALL				
<b>C6500 Topkick</b>					6.6L Optional					2				
2009-97	6.0L, 7.0L, 7.4L, 8.1L		78	600	<b>T7500</b>					2010-05 ALL				
2009-03	7.2L Optional	2,3	31T	750	2009-04	7.8L	2,3	31T	700	<b>185</b>				
	7.2L, 7.8L	2,3	31T	700	2009	7.8L Diesel	2	48	770	2010-05 ALL				
	7.8L Optional	2,3	31T	750	2002-99	7.8L Optional		31T	900	<b>195</b>				
	8.1L Optional	2	31T	700	2002-98	7.8L Optional		31T	750	2010-05 ALL				
	8.1L Optional		78	750	2002-97	7.2L Optional		31T	900	<b>195DC</b>				
2009	7.8L Diesel	2	48	730	2002-97	6.6L, 7.2L, 7.8L		31T	625	2014				
	8.1L		48	615	1998-97	6.0L		31T	78	ALL				
2002-99	7.2L Optional		31T	750	6.0L Optional					2				
	7.2L Optional		31T	900	6.0L Optional					<b>195h</b>				
2002-97	6.6L, 7.2L		31T	625	6.0L Optional					2014-13 ALL				
2002-01	8.1L Optional		31T	625	6.0L Optional					2				
	8.1L Optional		78	770	6.6L Optional					<b>195h DC</b>				
2000-99	7.4L Optional		31T	625	6.6L Optional					2014 ALL				
	7.4L Optional		78	770	6.6L Optional					2				
1998-97	6.0L Optional		31T	625	7.0L Optional					<b>238</b>				
	6.0L Optional		78	770	7.0L Optional					2014-05 ALL				
	6.6L Optional		31T	750	7.0L Optional					2				
	6.6L Optional		31T	900	7.0L Optional					<b>258ALP</b>				
	7.0L Optional		31T	625	7.0L Optional					2014-08 ALL				
	7.0L Optional		78	770	7.0L Optional					2				
<b>C7000 Topkick</b>					<b>W3500 Forward</b>					2014-06 ALL				
1996-95	6.0L Optional		31T	625	2008-05	5.2L	2,3	31T	700	2				
	6.0L Optional		78	770		5.2L Diesel	2	48	700	<b>195h DC</b>				
	6.0L, 7.0L		78	600		5.2L Optional	2,3	31T	750	2014 ALL				
	6.6L Optional		31T	900		6.0L Gas	2	48	700	<b>258LP</b>				
	7.0L Optional		31T	625	2008-04	6.0L Optional		31T	700	2014-05 ALL				
	7.0L Optional		78	770		6.0L Optional	2	31T	700	2				
1996	6.6L		31T	625	2008-00	4.8L, 5.7L, 6.0L		78	600	2014-08 ALL				
	6.6L Optional		31T	750	2004-00	4.8L Optional		31T	700	<b>258LP</b>				
1995	6.6L		31T	750		4.8L Optional	2	31T	700	2014-06 ALL				
<b>C7500 Topkick</b>					2003-00					2				
2009-97	6.0L, 7.0L, 7.4L, 8.1L		78	600		5.7L Optional		31T	700	<b>268</b>				
2009-03	7.2L Optional	2,3	31T	750		5.7L Optional	2	31T	700	2014-05 ALL				
	7.2L, 7.8L	2,3	31T	700	1999-95	4.8L, 5.7L		31T	630	2				
	7.8L Optional	2,3	31T	750		5.7L Optional		74	550	<b>308</b>				
	8.1L Optional	2	31T	700		5.7L Optional		78	540	2007 ALL				
	8.1L Optional		78	750	1999	4.8L Optional		31T	630	<b>338</b>				
2009	7.8L Diesel	2	48	730		4.8L Optional		74	550	2014-05 ALL				
	8.1L		48	615	1998-95	3.9L	2	31T	750	2				
2002-99	7.2L Optional		31T	750	<b>W4500 Forward</b>					<b>338CT</b>				
	7.2L Optional		31T	900	2010-05	5.2L	2,3	31T	700	2014-08 ALL				
2002-97	6.6L, 7.2L		31T	625		5.2L Optional	2,3	31T	750	<b>FA1415</b>				
2002-01	8.1L Optional		31T	625	2010-03	6.0L Optional		31T	700	1997-95 ALL				
2000-99	7.4L Optional		31T	625		6.0L Optional	2	31T	700	2004-98 ALL				
	7.4L Optional		78	770	2010-00	6.0L Optional		78	750	<b>FB1715</b>				
1998-97	6.0L Optional		31T	625	2004-00	4.8L, 5.7L, 6.0L		31T	700	1997-95 ALL				
	6.0L Optional		78	770		4.8L Optional	2	31T	700	2004-98 ALL				
	6.6L Optional		31T	750		4.8L Optional		78	750	<b>FB1817</b>				
	6.6L Optional		31T	900	2002-00	5.7L Optional		31T	700	2				
	7.0L Optional		31T	625		5.7L Optional	2	31T	700	<b>FD2218</b>				
	7.0L Optional		78	770	1999-98	4.8L, 5.7L		78	750	1997-95 ALL				
<b>T6500</b>					2010-05					2				
2009-04	7.8L	2,3	31T	700		5.7L Optional		31T	700	<b>FD2218LP</b>				
	7.8L Optional	2,3	31T	750		5.7L Optional		78	750	1997-95 ALL				
2009	7.8L Diesel	2	48	770		5.7L Optional		74	550	<b>FD2220</b>				
2002-99	7.8L Optional		31T	750		5.7L Optional		78	540	2002-98 ALL				
	7.8L Optional		31T	900		5.7L Optional		31T	630	<b>FD2320</b>				
2002-98	7.2L Optional		31T	750	1999	4.8L Optional		31T	630	2004-03 ALL				
	7.2L Optional		31T	900		4.8L Optional		74	550	<b>FE2618</b>				
2002-97	6.6L, 7.2L, 7.8L		31T	625	1998	4.8L Optional	2	31T	750	1997-95 ALL				
<b>W5500 Forward</b>					2010-05					2				
2009-05	5.2L	2,3	31T	700		3.9L		31T	750	<b>FE2620</b>				
	5.2L Optional	2,3	31T	750	2009-05	5.2L	2,3	31T	700	2004-98 ALL				
2004-00	4.8L		78	600		5.2L Optional	2,3	31T	750	<b>FF3018</b>				
	4.8L Optional		31T	700	2004-00	4.8L		78	600	1997-95 ALL				
	4.8L Optional		31T	700		4.8L Optional	2	31T	700	<b>FF3020</b>				
	4.8L Optional		78	750		4.8L Optional		31T	700	2004 8.0L				
<b>W5500HD Forward</b>					2009-05					2				
2009-05	5.2L	2,3	31T	700		4.8L Optional		31T	700	2002-95 6.5L, 8.0L				
	5.2L Optional	2,3	31T	750	2004	4.8L		78	600	<b>SG3320</b>				
2004	4.8L		31T	700		4.8L Optional	2	31T	700	2004 8.0L				
	4.8L Optional		31T	700		4.8L Optional		78	600	2002-95 6.5L, 8.0L				
	4.8L Optional		78	750		4.8L Optional		31T	700	<b>SG3323</b>				
	4.8L Optional		31T	700		4.8L Optional	2	31T	700	1997-95 ALL				

YEAR	ENGINE/ OPTIONS	FOOT NOTE	GROUP/ TYPE NO.	O.E. CCA (@0°F)	YEAR	ENGINE/ OPTIONS	FOOT NOTE	GROUP/ TYPE NO.	O.E. CCA (@0°F)	YEAR	ENGINE/ OPTIONS	FOOT NOTE	GROUP/ TYPE NO.	O.E. CCA (@0°F)
<b>HINO (Cont.)</b>					<b>INTERNATIONAL (Cont.)</b>					<b>INTERNATIONAL (Cont.)</b>				
Medium/Heavy Truck (Cont.)					Class 8 Truck (Cont.)					Medium/Heavy Truck				
<b>SG3325</b>					<b>5600i (Cont.)</b>					<b>1552SC</b>				
2004-98	ALL	2	31T	625	2013-12	10.8L Optional	4	31T	925	1998-96	ALL 7.3L Optional	4 4	31T 31T	650 925
<b>SG5523</b>					<b>5900</b>					<b>1652SC</b>				
1996-95	ALL	2	31T	625	2014-10	L Optional	4	31T	925	2012-95	ALL	4	31T	650
<b>HME</b>					2014-07	ALL	4	31T	650	2012-04	6.0L Optional	4	31T	925
Class 8 Truck					2009-07	8.9L Optional	4	31T	925	2005-95	7.3L Optional	4	31T	925
<b>1871</b>					<b>5900i SBA</b>					<b>1652UPS</b>				
2014-02	ALL	4	31T	925	2014-13	15.0L Optional	4	31T	925	1997-95	ALL 7.3L Optional	4 4	31T 31T	650 925
<b>Fire Truck</b>					2014-12	10.8L Optional	4	31T	925	<b>2554</b>				
2004-95	ALL	4	31T	925	2014-03	ALL	4	31T	650	2002-95	ALL	4	31T	650
<b>HT-700</b>					2011-03	15.0L Optional	4	31T	925	2002-95	7.6L Optional	4	31T	925
2004-95	ALL	4	31T	925	<b>7300</b>					2000-99	10.8L Optional	4	31T	925
<b>MD-3060</b>					2014-08	ALL	4	31T	650	2000-99	8.7L Optional	4	31T	925
2004-95	ALL	4	31T	925	2014-08	10.5L Optional	4	31T	925	2000-99	14.0L Optional	4	31T	925
<b>MT-643</b>					2014-08	12.4L Optional	4	31T	925	<b>2574</b>				
2004-95	ALL	4	31T	925	2014-07	7.6L Optional	4	31T	925	2003-95	ALL	4	31T	650
<b>MT-647</b>					2014-07	7.6L, 9.3L, 10.5L, 12.4L	4	31T	650	2003-95	10.8L Optional	4	31T	925
2004-95	ALL	4	31T	925	2004-03	9.3L 9.3L Optional	4 4	31T 31T	650 925	2003-01	14.0L Optional	4	31T	925
<b>VT-100</b>					2004-03	9.3L	4	31T	650	1998-95	8.7L Optional	4	31T	925
2002-95	ALL	4	31T	925	<b>7500</b>					1998-95	10.0L Optional	4	31T	925
<b>IC</b>					2014-08	10.5L Optional	4	31T	925	<b>2654</b>				
Motor Coach Bus Chassis					2014-08	12.4L Optional	4	31T	925	2002-95	ALL	4	31T	650
<b>HC Series</b>					2014-07	9.3L Optional	4	31T	925	2002-95	7.6L Optional	4	31T	925
2014-10	ALL	2	31T	1100	2004-03	9.3L, 10.5L, 12.4L	4	31T	650	2000-99	8.7L Optional	4	31T	925
<b>Hybrid HC</b>					2004-03	9.3L	4	31T	650	2000-99	10.8L Optional	4	31T	925
2014-10	ALL	2	31T	1100	2004-03	9.3L Optional	4	31T	925	2000-99	14.0L Optional	4	31T	925
School Bus Chassis					<b>7600</b>					<b>2674</b>				
<b>Hybrid CE</b>					2014-08	10.5L Optional	4	31T	925	2003-95	ALL	4	31T	650
2014-10	ALL	2	31T	1100	2014-08	12.4L Optional	4	31T	925	2003-95	10.8L Optional	4	31T	925
<b>Multi BE</b>					2014-04	10.8L Optional	4	31T	925	2003-95	14.0L Optional	4	31T	925
2014-10	ALL	2	31T	1100	2014-03	ALL	4	31T	650	2003-01	8.7L Optional	4	31T	925
<b>Multi CE</b>					2014-03	11.2L Optional	4	31T	925	2003-01	7.6L Optional	4	31T	925
2014-10	ALL	2	31T	1100	2014-03	12.5L Optional	4	31T	925	1998-95	10.0L Optional	4	31T	925
<b>Multi FE</b>					<b>7700</b>					<b>3000</b>				
2014-10	ALL	2	31T	1100	2014-08	10.5L Optional	4	31T	925	2002-96	ALL	4	31T	650
<b>Multi RE</b>					2014-08	10.8L Optional	4	31T	925	2000-97	7.6L Optional	4	31T	925
2014-10	ALL	2	31T	1100	2014-06	12.4L Optional	4	31T	925	2000-97	7.3L Optional	4	31T	925
Shuttle Bus Chassis					2014-06	ALL	4	31T	650	<b>3000FE</b>				
<b>LC Series</b>					2014-06	11.2L Optional	4	31T	925	1999-97	ALL	4	31T	650
2014-10	ALL	2	31T	1100	2014-06	12.5L Optional	4	31T	925	1999-97	7.6L Optional	4	31T	925
<b>INTERNATIONAL</b>					<b>8500 TranStar</b>					<b>3000IC</b>				
Class 8 Truck					2014-12	9.3L	4	31T	650	2002-00	ALL	4	31T	650
<b>4400</b>					2007-04	9.3L	4	31T	650	2002-00	7.3L Optional	4	31T	925
2004-03	ALL	4	31T	650	<b>8600</b>					2002-00	7.6L Optional	4	31T	925
2004-03	9.3L Optional	4	31T	925	2014-03	ALL	4	31T	650	<b>3000RE</b>				
<b>4400 Fire Truck</b>					<b>9200</b>					2005	7.6L	4	31T	650
2008-99	10.8L	4	31T	650	2008-97	ALL	4	31T	650	2005	7.6L Optional	4	31T	925
2008-99	10.8L Optional	4	31T	925	<b>9400</b>					2002	8.7L	4	31T	650
2000-99	10.8L	2	31T	550	2009-99	ALL	4	31T	650	2002	8.7L Optional	4	31T	925
<b>4700</b>					<b>9900</b>					<b>3200</b>				
2004-03	ALL	4	31T	650	2009-03	10.8L, 12.5L, 14.0L, 15.0L, 15.1L, 15.8L	4	31T	650	2011-02	ALL	4	31T	650
2004-03	7.6L Optional	4	31T	925	2009-03	15.0L Optional	4	31T	925	2011-02	6.0L Optional	4	31T	925
<b>4900</b>					2008-04	14.0L Optional	4	31T	925	2006-02	7.6L Optional	4	31T	925
2004-03	ALL	4	31T	650	2008-03	12.5L Optional	4	31T	925	2004-03	8.7L Optional	4	31T	925
2004-03	7.6L Optional	4	31T	925	2008-03	15.1L Optional	4	31T	925	<b>3300</b>				
<b>5500</b>					2007-06	12.5L, 14.0L, 15.0L, 15.1L, 15.8L	4	31T	925	2011-05	ALL	4	31T	650
2012-03	ALL	4	31T	650	2005-04	10.8L Optional	4	31T	925	2011-05	6.0L Optional	4	31T	925
2012-03	15.0L Optional	4	31T	925	<b>LoneStar</b>					2002-96	ALL	4	31T	650
<b>5500i</b>					<b>ProStar</b>					2002-96	7.3L Optional	4	31T	925
2013-12	ALL	4	31T	650	2014-08	ALL	4	31T	650	2001	7.6L	4	31T	650
2013-12	10.8L Optional	4	31T	925	2014-08	10.5L Optional	4	31T	925	2001	7.6L Optional	4	31T	925
<b>5600</b>					2014-08	12.4L Optional	4	31T	925	1999-95	6.7L, 7.3L, 7.6L	4	31T	650
2012-04	ALL	4	31T	650	2014-08	15.0L Optional	4	31T	925	1999-95	7.3L Optional	4	31T	925
2012-04	15.0L Optional	4	31T	925	2008	15.1L Optional	4	31T	925	1995	7.6L Optional	4	31T	925
<b>5600i</b>					<b>ProStar</b>					1995	6.7L Optional	4	31T	925
2013-12	ALL	4	31T	650	2014-07	ALL	4	31T	650	<b>3800</b>				
										2004-95	ALL	4	31T	650
										2004-95	7.6L Optional	4	31T	925

# Trucks

YEAR	ENGINE/ OPTIONS	FOOT NOTE	GROUP/ TYPE NO.	O.E. CCA (@0°F)	YEAR	ENGINE/ OPTIONS	FOOT NOTE	GROUP/ TYPE NO.	O.E. CCA (@0°F)	YEAR	ENGINE/ OPTIONS	FOOT NOTE	GROUP/ TYPE NO.	O.E. CCA (@0°F)
<b>INTERNATIONAL (Cont.)</b>					<b>INTERNATIONAL (Cont.)</b>					<b>INTERNATIONAL (Cont.)</b>				
<b>Medium/Heavy Truck (Cont.)</b>					<b>Medium/Heavy Truck (Cont.)</b>					<b>Medium/Heavy Truck (Cont.)</b>				
<b>3800 (Cont.)</b>					<b>4700LPX (Cont.)</b>					<b>8100 (Cont.)</b>				
2004	7.3L Optional	4	31T	925	2002-95	7.3L Optional	4	31T	925	1999-95	14.0L Optional	4	31T	925
2002-95	7.3L Optional	4	31T	925	<b>4800</b>					1998-95	10.0L Optional	4	31T	925
1995	6.7L Optional	4	31T	925	2003-96	8.7L Optional	4	31T	925		8.5L Optional	4	31T	925
<b>3900FC</b>					2003-95	ALL	4	31T	650	1996	11.1L Optional	4	31T	925
1996	ALL	4	31T	650		7.6L Optional	4	31T	925		12.7L Optional	4	31T	925
	7.6L Optional	4	31T	925	1997-95	7.3L Optional	4	31T	925	<b>8200</b>				
<b>4100</b>					<b>4900</b>					1997-96	7.6L Optional	4	31T	925
2014-13	L Optional	4	31T	925	2003-95	ALL	4	31T	650		8.7L Optional	4	31T	925
2014-06	ALL	4	31T	650		7.6L Optional	4	31T	925	1997-95	ALL	4	31T	650
2012-06	6.0L Optional	4	31T	925		8.7L Optional	4	31T	925		10.0L Optional	4	31T	925
<b>4100 HYBRID</b>					1997-95	6.7L Optional	4	31T	925		10.8L Optional	4	31T	925
2014-09	ALL	4	31T	650		7.3L Optional	4	31T	925		11.1L Optional	4	31T	925
	L Optional	4	31T	925	<b>5000</b>						14.0L Optional	4	31T	925
<b>4100 SBA</b>					1999-95	ALL	4	31T	650	1996-95	12.7L Optional	4	31T	925
2008-06	ALL	4	31T	650		10.8L Optional	4	31T	925	<b>8500</b>				
	6.0L Optional	4	31T	925		14.0L Optional	4	31T	925	2007-02	ALL	4	31T	650
<b>4200</b>					1998-95	10.0L Optional	4	31T	925	<b>8500 TranStar</b>				
2014-09	L Optional	4	31T	925	<b>5500i</b>					2011-08	ALL	4	31T	650
2014-02	ALL	4	31T	650	2011-07	8.9L Optional	4	31T	925	<b>8600 SBA</b>				
2008-02	6.0L Optional	4	31T	925	2011-00	ALL	4	31T	650	2007-03	ALL	4	31T	650
<b>4200LP</b>						10.8L Optional	4	31T	925	<b>8600 TranStar</b>				
2007-03	ALL	4	31T	650	2005-00	8.7L Optional	4	31T	925	2014-08	ALL	4	31T	650
	6.0L Optional	4	31T	925	2003-00	14.0L Optional	4	31T	925	<b>9100 SBA</b>				
<b>4300</b>					2002-01	7.6L Optional	4	31T	925	1999-98	ALL	4	31T	650
2014-13	L Optional	4	31T	925	<b>5600i</b>						10.8L Optional	4	31T	925
2014-02	ALL	4	31T	650	2011-07	8.9L Optional	4	31T	925		11.1L Optional	4	31T	925
2012-02	7.6L Optional	4	31T	925	2011-00	ALL	4	31T	650		14.0L Optional	4	31T	925
2003	6.0L Optional	4	31T	925		10.8L Optional	4	31T	925	<b>9100i SBA</b>				
<b>4300 HYBRID</b>					2005-00	8.7L Optional	4	31T	925	2003-01	12.7L Optional	4	31T	925
2014-09	ALL	4	31T	650	2003-00	14.0L Optional	4	31T	925	2003-00	ALL	4	31T	650
	L Optional	4	31T	925	2002-01	7.6L Optional	4	31T	925		10.8L Optional	4	31T	925
<b>4300LP</b>					<b>5900i SBA</b>						14.0L Optional	4	31T	925
2012-02	ALL	4	31T	650	2012-00	ALL	4	31T	650	2000	11.1L Optional	4	31T	925
	7.6L Optional	4	31T	925	2012	15.0L Optional	4	31T	925	<b>9200 SBA</b>				
	L Optional	4	31T	925	2011-00	10.8L Optional	4	31T	925	1999-95	ALL	4	31T	650
<b>4400</b>					2003-00	14.0L Optional	4	31T	925	<b>9200i SBA</b>				
2014-13	L Optional	4	31T	925	<b>7100</b>					2011-00	ALL	4	31T	650
2014-02	ALL	4	31T	650	1995	ALL	4	31T	650	<b>9300</b>				
2012-02	7.6L Optional	4	31T	925		7.3L Optional	4	31T	925	1998-95	ALL	4	31T	650
2008-04	9.3L Optional	4	31T	925		7.6L Optional	4	31T	925		10.8L Optional	4	31T	925
2005-02	8.7L Optional	4	31T	925		8.7L Optional	4	31T	925		11.1L Optional	4	31T	925
2003	6.0L Optional	4	31T	925	<b>7300</b>						12.7L Optional	4	31T	925
<b>4400 HYBRID</b>					2006-02	ALL	4	31T	650		14.0L Optional	4	31T	925
2014-09	ALL	4	31T	650		7.6L Optional	4	31T	925	<b>9400</b>				
	L Optional	4	31T	925	<b>7300 SBA</b>					1999-95	ALL	4	31T	650
<b>4400LP</b>					2007-02	ALL	4	31T	650	<b>9400i SBA</b>				
2014-13	L Optional	4	31T	925		7.6L Optional	4	31T	925	2011-00	ALL	4	31T	650
2014-02	ALL	4	31T	650	<b>7400</b>					<b>9600</b>				
2012-02	7.6L Optional	4	31T	925	2007-05	9.3L Optional	4	31T	925	1996-95	ALL	4	31T	650
2007-05	9.3L Optional	4	31T	925	2007-02	ALL	4	31T	650	<b>9700</b>				
2005-02	8.7L Optional	4	31T	925		7.6L Optional	4	31T	925	1996-95	ALL	4	31T	650
<b>4600</b>					2005-02	8.7L Optional	4	31T	925	<b>9800 SBA</b>				
1995	ALL	4	31T	650	2005	10.8L Optional	4	31T	925	1999-96	ALL	4	31T	650
	7.3L Optional	4	31T	925	<b>7500</b>					<b>9900 SFA</b>				
<b>4700</b>					2007-04	9.3L Optional	4	31T	925	1999	ALL	4	31T	650
2005	6.7L	4	31T	650	2007-02	ALL	4	31T	650		10.8L Optional	4	31T	925
	6.7L Optional	4	31T	925	2004-02	8.7L Optional	4	31T	925		11.1L Optional	4	31T	925
2003-96	8.7L Optional	4	31T	925	2002	7.6L Optional	4	31T	925		14.0L Optional	4	31T	925
2003-95	6.7L, 7.3L, 7.6L, 8.7L	4	31T	650	<b>7600</b>					<b>9900i</b>				
	7.6L Optional	4	31T	925	2007-03	ALL	4	31T	650	2014-13	ALL	4	31T	650
2002-95	7.3L Optional	4	31T	925		10.8L Optional	4	31T	925		L Optional	4	31T	925
2001-00	6.7L Optional	4	31T	925	2007	9.3L Optional	4	31T	925	<b>9900i SFA</b>				
1997-95	6.7L Optional	4	31T	925	<b>7700</b>					2003-01	12.7L Optional	4	31T	925
<b>4700LP</b>					2007-05	ALL	4	31T	650	2003-00	ALL	4	31T	650
2002-97	8.7L Optional	4	31T	925		10.8L Optional	4	31T	925		10.8L Optional	4	31T	925
2002-95	ALL	4	31T	650		9.3L Optional	4	31T	925		14.0L Optional	4	31T	925
	7.3L Optional	4	31T	925	<b>8100</b>						11.1L Optional	4	31T	925
	7.6L Optional	4	31T	925	2007	9.3L Optional	4	31T	925	2000	11.1L Optional	4	31T	925
	6.7L Optional	4	31T	925	<b>7700</b>					<b>9900ix SFA</b>				
1995	6.7L Optional	4	31T	925	2007-05	ALL	4	31T	650	2003-01	ALL	4	31T	650
<b>4700LPX</b>						10.8L Optional	4	31T	925		14.0L Optional	4	31T	925
2002-95	ALL	4	31T	650	2007	9.3L Optional	4	31T	925					
					2002-95	ALL	4	31T	650					
						10.8L Optional	4	31T	925					
						7.6L Optional	4	31T	925					
						8.7L Optional	4	31T	925					





YEAR	ENGINE/ OPTIONS	FOOT NOTE	GROUP/ TYPE NO.	O.E. CCA (@0°F)	YEAR	ENGINE/ OPTIONS	FOOT NOTE	GROUP/ TYPE NO.	O.E. CCA (@0°F)	YEAR	ENGINE/ OPTIONS	FOOT NOTE	GROUP/ TYPE NO.	O.E. CCA (@0°F)
<b>KENWORTH (Cont.)</b>					<b>KENWORTH (Cont.)</b>					<b>KENWORTH (Cont.)</b>				
<b>Class 8 Truck (Cont.)</b>					<b>Class 8 Truck (Cont.)</b>					<b>Class 8 Truck (Cont.)</b>				
<b>On Highway Conventional (Cont.)</b>					<b>T450 (Cont.)</b>					<b>T680</b>				
1997	14.6L Std. 12-volt	3	31T	625	1996-95	10.3L Opt. 12-volt	4	31T	625	2014-12	ALL	4	31T	925
	15.0L Opt. 12-volt	2	31T	925		10.3L Opt. 6-volt	4	4	940	<b>T700</b>				
	15.0L Opt. 12-volt	3	31T	700		10.3L Std. 12-volt	3	31T	625	2014-10	ALL	4	31T	925
	15.0L Opt. 12-volt	3	31T	750		14.6L Opt. 12-volt	2	31T	925	<b>T800</b>				
	15.0L Opt. 12-volt	3	31T	900		14.6L Opt. 12-volt	3	31T	700	2014-03	ALL	4	31T	925
	15.0L Opt. 12-volt	4	31T	550		14.6L Opt. 12-volt	3	31T	900	1996-95	10.0L Opt. 12-volt	2	31T	925
	15.0L Opt. 12-volt	4	31T	625		14.6L Opt. 12-volt	3	31T	550		10.0L Opt. 12-volt	3	31T	700
	15.0L Opt. 6-volt	4	4	940		14.6L Std. 12-volt	4	31T	625		10.0L Opt. 12-volt	3	31T	750
	15.0L Std. 12-volt	3	31T	625		14.6L Opt. 12-volt	4	31T	625		10.0L Opt. 12-volt	3	31T	900
	8.3L Opt. 12-volt	2	31T	925		14.6L Opt. 6-volt	4	4	940		10.0L Opt. 12-volt	4	31T	550
	8.3L Opt. 12-volt	3	31T	700		14.6L Std. 12-volt	3	31T	625		10.0L Opt. 12-volt	4	31T	625
	8.3L Opt. 12-volt	3	31T	750		8.3L Opt. 12-volt	2	31T	925		10.0L Opt. 12-volt	4	31T	625
	8.3L Opt. 12-volt	3	31T	900		8.3L Opt. 12-volt	3	31T	700		10.0L Opt. 6-volt	4	4	940
	8.3L Opt. 12-volt	4	31T	550		8.3L Opt. 12-volt	3	31T	750		10.0L Std. 12-volt	3	31T	625
	8.3L Opt. 12-volt	4	31T	625		8.3L Opt. 12-volt	3	31T	900		10.3L Opt. 12-volt	2	31T	925
	8.3L Opt. 6-volt	4	4	940		8.3L Opt. 12-volt	4	31T	550		10.3L Opt. 12-volt	3	31T	700
	8.3L Std. 12-volt	3	31T	625		8.3L Opt. 12-volt	4	31T	625		10.3L Opt. 12-volt	3	31T	900
<b>On/Off Highway Conventional</b>						8.3L Opt. 6-volt	4	4	940		10.3L Opt. 12-volt	4	31T	550
						8.3L Std. 12-volt	3	31T	625		10.3L Opt. 12-volt	4	31T	625
2002-01	12.7L, 14.0L	4	31T	925	<b>T460</b>						10.3L Opt. 6-volt	4	4	940
2000-98	12.7L Optional	2	31T	925	2014-10	ALL	4	31T	925		10.3L Std. 12-volt	3	31T	625
	12.7L Optional	3	31T	625	<b>T470</b>						10.8L Opt. 12-volt	2	31T	925
	12.7L Optional	3	31T	750	2014-09	ALL	4	31T	925		10.8L Opt. 12-volt	3	31T	700
	12.7L Optional	3	31T	900	<b>T600</b>						10.8L Opt. 12-volt	3	31T	750
	12.7L Optional	4	31T	550	2006-03	ALL	4	31T	925		10.8L Opt. 12-volt	3	31T	900
	12.7L, 14.0L, 14.6L	3	31T	650	1996-95	10.0L Opt. 12-volt	2	31T	925		10.8L Opt. 12-volt	4	31T	550
	14.0L Optional	2	31T	925		10.0L Opt. 12-volt	3	31T	700		10.8L Opt. 12-volt	4	31T	625
	14.0L Optional	3	31T	625		10.0L Opt. 12-volt	3	31T	750		10.8L Opt. 6-volt	4	4	940
	14.0L Optional	3	31T	750		10.0L Opt. 12-volt	3	31T	900		10.8L Std. 12-volt	3	31T	625
	14.0L Optional	3	31T	900		10.0L Opt. 12-volt	3	31T	900		11.1L Opt. 12-volt	2	31T	925
	14.0L Optional	4	31T	550		10.0L Opt. 12-volt	4	31T	550		11.1L Opt. 12-volt	3	31T	700
	14.6L Optional	2	31T	925		10.0L Opt. 12-volt	4	31T	625		11.1L Opt. 12-volt	3	31T	750
	14.6L Optional	3	31T	625		10.0L Opt. 6-volt	4	4	940		11.1L Opt. 12-volt	3	31T	900
	14.6L Optional	3	31T	750		10.0L Std. 12-volt	3	31T	625		11.1L Opt. 12-volt	4	31T	550
	14.6L Optional	3	31T	900		10.3L Opt. 12-volt	2	31T	925		11.1L Opt. 12-volt	4	31T	625
	14.6L Optional	4	31T	550		10.3L Opt. 12-volt	3	31T	700		11.1L Opt. 6-volt	4	4	940
<b>T2000</b>						10.3L Opt. 12-volt	3	31T	750		11.1L Std. 12-volt	3	31T	625
2011-03	ALL	4	31T	925		10.3L Opt. 12-volt	3	31T	900		12.7L Opt. 12-volt	2	31T	925
<b>T400</b>						10.3L Opt. 12-volt	4	31T	550		12.7L Opt. 12-volt	3	31T	700
1996-95	10.0L Opt. 12-volt	2	31T	925		10.3L Opt. 12-volt	4	31T	625		12.7L Opt. 12-volt	3	31T	750
	10.0L Opt. 12-volt	3	31T	700		10.3L Opt. 6-volt	4	4	940		12.7L Opt. 12-volt	3	31T	900
	10.0L Opt. 12-volt	3	31T	750		10.3L Std. 12-volt	3	31T	625		12.7L Opt. 12-volt	4	31T	550
	10.0L Opt. 12-volt	3	31T	900		11.1L Opt. 12-volt	2	31T	925		12.7L Opt. 12-volt	4	31T	625
	10.0L Opt. 12-volt	4	31T	550		11.1L Opt. 12-volt	3	31T	700		12.7L Opt. 6-volt	4	4	940
	10.0L Opt. 12-volt	4	31T	625		11.1L Opt. 12-volt	3	31T	750		12.7L Std. 12-volt	3	31T	625
	10.0L Opt. 6-volt	4	4	940		11.1L Opt. 12-volt	3	31T	900		14.0L Opt. 12-volt	2	31T	925
	10.0L Std. 12-volt	3	31T	625		11.1L Opt. 12-volt	4	31T	550		14.0L Opt. 12-volt	3	31T	700
	10.3L Opt. 12-volt	3	31T	925		11.1L Opt. 12-volt	4	31T	625		14.0L Opt. 12-volt	3	31T	750
	10.3L Opt. 12-volt	3	31T	700		11.1L Opt. 6-volt	4	4	940		14.0L Opt. 12-volt	3	31T	900
	10.3L Opt. 12-volt	3	31T	750		11.1L Std. 12-volt	3	31T	625		14.0L Opt. 12-volt	4	31T	550
	10.3L Opt. 12-volt	3	31T	900		12.7L Opt. 12-volt	2	31T	925		14.0L Opt. 12-volt	4	31T	625
	10.3L Opt. 12-volt	4	31T	550		12.7L Opt. 12-volt	3	31T	700		14.0L Opt. 12-volt	4	31T	625
	10.3L Opt. 12-volt	4	31T	625		12.7L Opt. 12-volt	3	31T	750		14.0L Opt. 6-volt	4	4	940
	10.3L Opt. 6-volt	4	4	940		12.7L Opt. 12-volt	3	31T	900		14.0L Std. 12-volt	3	31T	625
	10.3L Std. 12-volt	3	31T	625		12.7L Opt. 12-volt	4	31T	550		14.6L Opt. 12-volt	2	31T	925
	8.3L Opt. 12-volt	2	31T	925		12.7L Opt. 12-volt	4	31T	625		14.6L Opt. 12-volt	3	31T	700
	8.3L Opt. 12-volt	3	31T	700		12.7L Opt. 12-volt	4	31T	625		14.6L Opt. 12-volt	3	31T	750
	8.3L Opt. 12-volt	3	31T	750		12.7L Opt. 6-volt	4	4	940		14.6L Opt. 12-volt	3	31T	900
	8.3L Opt. 12-volt	3	31T	900		12.7L Std. 12-volt	3	31T	625		14.6L Opt. 12-volt	4	31T	550
	8.3L Opt. 12-volt	3	31T	900		14.0L Opt. 12-volt	2	31T	925		14.6L Opt. 12-volt	4	31T	625
	8.3L Opt. 12-volt	4	31T	550		14.0L Opt. 12-volt	3	31T	700		14.6L Opt. 6-volt	4	4	940
	8.3L Opt. 12-volt	4	31T	625		14.0L Opt. 12-volt	3	31T	750		14.6L Std. 12-volt	3	31T	625
	8.3L Opt. 6-volt	4	4	940		14.0L Opt. 12-volt	3	31T	900	<b>T880</b>				
	8.3L Std. 12-volt	3	31T	625		14.0L Opt. 12-volt	4	31T	550	2014-13	ALL	4	31T	925
<b>T450</b>						14.0L Opt. 12-volt	4	31T	625	<b>T953</b>				
1996-95	10.0L Opt. 12-volt	2	31T	925		14.0L Opt. 6-volt	4	4	940	1996-95	10.3L Opt. 12-volt	2	31T	925
	10.0L Opt. 12-volt	3	31T	700		14.0L Std. 12-volt	3	31T	625		10.3L Opt. 12-volt	3	31T	700
	10.0L Opt. 12-volt	3	31T	750		14.6L Opt. 12-volt	2	31T	925		10.3L Opt. 12-volt	3	31T	750
	10.0L Opt. 12-volt	3	31T	900		14.6L Opt. 12-volt	3	31T	700		10.3L Opt. 12-volt	3	31T	900
	10.0L Opt. 12-volt	4	31T	550		14.6L Opt. 12-volt	3	31T	750		10.3L Opt. 12-volt	4	31T	550
	10.0L Opt. 12-volt	4	31T	625		14.6L Opt. 12-volt	3	31T	900		10.3L Opt. 12-volt	4	31T	625
	10.0L Opt. 6-volt	4	4	940		14.6L Opt. 12-volt	4	31T	550		10.3L Opt. 12-volt	4	31T	625
	10.0L Std. 12-volt	3	31T	625		14.6L Opt. 12-volt	4	31T	625		10.3L Opt. 6-volt	4	4	940
	10.3L Opt. 12-volt	2	31T	925		14.6L Opt. 6-volt	4	4	940		10.3L Std. 12-volt	3	31T	625
	10.3L Opt. 12-volt	3	31T	700		14.6L Std. 12-volt	3	31T	625		14.0L Opt. 12-volt	2	31T	925
	10.3L Opt. 12-volt	3	31T	750	<b>T660</b>						14.0L Opt. 12-volt	3	31T	700
	10.3L Opt. 12-volt	3	31T	900	2014-07	ALL	4	31T	925		14.0L Opt. 12-volt	3	31T	750
	10.3L Opt. 12-volt	4	31T	550							14.0L Opt. 12-volt	3	31T	900

# Trucks

YEAR	ENGINE/OPTIONS	FOOT NOTE	GROUP/TYPE NO.	O.E. CCA (@0°F)	YEAR	ENGINE/OPTIONS	FOOT NOTE	GROUP/TYPE NO.	O.E. CCA (@0°F)	YEAR	ENGINE/OPTIONS	FOOT NOTE	GROUP/TYPE NO.	O.E. CCA (@0°F)
<b>KENWORTH (Cont.)</b>					<b>KENWORTH (Cont.)</b>					<b>KENWORTH (Cont.)</b>				
<b>Class 8 Truck (Cont.)</b>					<b>Class 8 Truck (Cont.)</b>					<b>Medium/Heavy Truck (Cont.)</b>				
<b>T953 (Cont.)</b>					<b>W900 (Cont.)</b>					<b>T300</b>				
1996-95	14.0L Opt. 12-volt	4	31T	550	1996-95	12.7L Opt. 12-volt	4	31T	625	2003-01	5.9L, 7.2L, 8.3L	4	31T	925
	14.0L Opt. 12-volt	4	31T	625		12.7L Opt. 6-volt	4	4	940	2000-98	5.9L Optional	2	31T	925
	14.0L Opt. 6-volt	4	4	940		12.7L Std. 12-volt	3	31T	625		5.9L Optional	3	31T	625
	14.0L Std. 12-volt	3	31T	625		14.0L Opt. 12-volt	2	31T	925		5.9L Optional	3	31T	750
	14.6L Opt. 12-volt	2	31T	925		14.0L Opt. 12-volt	3	31T	700		5.9L Optional	3	31T	900
	14.6L Opt. 12-volt	3	31T	700		14.0L Opt. 12-volt	3	31T	750		5.9L Optional	4	31T	550
	14.6L Opt. 12-volt	3	31T	750		14.0L Opt. 12-volt	3	31T	900		5.9L, 7.2L, 8.3L	3	31T	650
	14.6L Opt. 12-volt	3	31T	900		14.0L Opt. 12-volt	4	31T	550		7.2L Optional	2	31T	925
	14.6L Opt. 12-volt	4	31T	550		14.0L Opt. 12-volt	4	31T	625		7.2L Optional	3	31T	625
	14.6L Opt. 12-volt	4	31T	625		14.0L Opt. 6-volt	4	4	940		7.2L Optional	3	31T	750
	14.6L Opt. 6-volt	4	4	940		14.0L Std. 12-volt	3	31T	625		7.2L Optional	3	31T	900
	14.6L Std. 12-volt	3	31T	625		14.6L Opt. 12-volt	2	31T	925		7.2L Optional	4	31T	550
	8.3L Opt. 12-volt	2	31T	925		14.6L Opt. 12-volt	3	31T	700		8.3L Optional	2	31T	925
	8.3L Opt. 12-volt	3	31T	700		14.6L Opt. 12-volt	3	31T	750		8.3L Optional	3	31T	625
	8.3L Opt. 12-volt	3	31T	750		14.6L Opt. 12-volt	3	31T	900		8.3L Optional	3	31T	750
	8.3L Opt. 12-volt	3	31T	900		14.6L Opt. 12-volt	4	31T	550		8.3L Optional	3	31T	900
	8.3L Opt. 12-volt	4	31T	550		14.6L Opt. 12-volt	4	31T	625		8.3L Optional	4	31T	550
	8.3L Opt. 12-volt	4	31T	625		14.6L Opt. 6-volt	4	4	940	2000	5.9L Optional	4	31T	925
	8.3L Opt. 6-volt	4	4	940		14.6L Std. 12-volt	3	31T	625		7.2L Optional	4	31T	925
	8.3L Std. 12-volt	3	31T	625	1995	10.3L Opt. 12-volt	2	31T	925		8.3L Optional	4	31T	925
<b>T993</b>						10.3L Opt. 12-volt	3	31T	700	1997-96	5.9L Opt. 12-volt	2	31T	925
1996-95	14.6L Opt. 12-volt	2	31T	925		10.3L Opt. 12-volt	3	31T	750		5.9L Opt. 12-volt	3	31T	700
	14.6L Opt. 12-volt	3	31T	700		10.3L Opt. 12-volt	3	31T	900		5.9L Opt. 12-volt	3	31T	750
	14.6L Opt. 12-volt	3	31T	750		10.3L Opt. 12-volt	4	31T	550		5.9L Opt. 12-volt	3	31T	900
	14.6L Opt. 12-volt	3	31T	900		10.3L Opt. 12-volt	4	31T	625		5.9L Opt. 12-volt	4	31T	550
	14.6L Opt. 12-volt	4	31T	550		10.3L Opt. 6-volt	4	4	940		5.9L Opt. 12-volt	4	31T	625
	14.6L Opt. 12-volt	4	31T	625		10.3L Std. 12-volt	3	31T	625		5.9L Opt. 6-volt	4	4	940
	14.6L Opt. 6-volt	4	4	940	<b>Medium/Heavy Truck</b>						5.9L Std. 12-volt	3	31T	625
	14.6L Std. 12-volt	3	31T	625	<b>K270</b>						7.2L Opt. 12-volt	2	31T	925
<b>W300</b>					2014-13	ALL	4	31T	925	<b>T300 Medium Duty</b>				
1996-95	10.3L Opt. 12-volt	2	31T	925	<b>K300</b>					2007-04	ALL	4	31T	925
	10.3L Opt. 12-volt	3	31T	700	2005-01	5.9L	4	31T	925	<b>T370</b>				
	10.3L Opt. 12-volt	3	31T	750	2000-98	5.9L, 8.3L	3	31T	650	2014-08	ALL	4	31T	925
	10.3L Opt. 12-volt	3	31T	900	2000	5.9L Optional	2	31T	925	<b>T370 HYBRID</b>				
	10.3L Opt. 12-volt	4	31T	550	2000	5.9L Optional	3	31T	625	2014-09	ALL	4	31T	925
	10.3L Opt. 12-volt	4	31T	625	2000	5.9L Optional	3	31T	750	<b>T440</b>				
	10.3L Opt. 6-volt	4	4	940	1999-98	5.9L Optional	3	31T	900	2014-10	ALL	4	31T	925
	10.3L Std. 12-volt	3	31T	625	1999-98	5.9L Optional	4	31T	550	<b>KME</b>				
	8.3L Opt. 12-volt	2	31T	925	1999-98	5.9L Optional	4	31T	925	<b>Class 8 Fire/Crash</b>				
	8.3L Opt. 12-volt	3	31T	700	1999-98	8.3L Optional	2	31T	925	<b>AARF</b>				
	8.3L Opt. 12-volt	3	31T	750	1999-98	8.3L Optional	3	31T	625	2009-00	12.7L, 14.0L, 14.6L	5	31T	925
	8.3L Opt. 12-volt	3	31T	900	1999-98	8.3L Optional	3	31T	750	1999-95	12.7L, 14.0L, 14.6L	4	31T	950
	8.3L Opt. 12-volt	4	31T	625	1997-95	8.3L Optional	3	31T	900	<b>Excel Chassis</b>				
	8.3L Opt. 12-volt	4	31T	625	1997-95	8.3L Opt. 12-volt	2	31T	925	2014-00	L, 12.7L, 14.0L, 14.6L, 14.8L	5	31T	925
	8.3L Opt. 6-volt	4	4	940	1997-95	8.3L Opt. 12-volt	3	31T	700	1999-96	12.7L, 14.0L, 14.6L	4	31T	950
	8.3L Std. 12-volt	3	31T	625	1997-95	8.3L Opt. 12-volt	3	31T	750	<b>Firefox</b>				
<b>W900</b>					1996-95	5.9L Opt. 12-volt	2	31T	925	2014-00	L, 10.3L, 10.8L, 12.7L	5	31T	925
2014-03	ALL	4	31T	925	1996-95	5.9L Opt. 12-volt	3	31T	700	1999-97	9.1L, 10.3L, 10.8L	4	31T	950
1996-95	10.0L Opt. 12-volt	2	31T	925	1996-95	5.9L Opt. 12-volt	3	31T	750	<b>Hawk</b>				
	10.0L Opt. 12-volt	3	31T	700	1996-95	5.9L Opt. 12-volt	3	31T	900	2014-00	L, 10.3L, 10.8L, 12.7L	5	31T	925
	10.0L Opt. 12-volt	3	31T	750	1996-95	5.9L Opt. 12-volt	4	31T	550	1999-97	9.1L, 10.3L, 10.8L	4	31T	950
	10.0L Opt. 12-volt	3	31T	900	1996-95	5.9L Opt. 12-volt	4	31T	625	<b>Predator</b>				
	10.0L Opt. 12-volt	4	31T	550	1996-95	5.9L Opt. 6-volt	4	4	940	2014-07	ALL	5	31T	925
	10.0L Opt. 12-volt	4	31T	625	1996-95	5.9L Std. 12-volt	3	31T	625					
	10.0L Opt. 6-volt	4	4	940	<b>K370</b>									
	10.0L Std. 12-volt	3	31T	625	2014-12	ALL	4	31T	925					
	10.8L Opt. 12-volt	2	31T	925	<b>KW45</b>									
	10.8L Opt. 12-volt	3	31T	700	2014-10	ALL	4	31T	925					
	10.8L Opt. 12-volt	3	31T	750	<b>KW55</b>									
	10.8L Opt. 12-volt	3	31T	900	2014-10	ALL	4	31T	925					
	10.8L Opt. 12-volt	3	31T	900	<b>T170</b>									
	10.8L Opt. 12-volt	4	31T	550	2014-08	ALL	4	31T	925					
	10.8L Opt. 12-volt	4	31T	625	<b>T170 HYBRID</b>									
	10.8L Opt. 6-volt	4	4	940	2014-09	ALL	4	31T	925					
	10.8L Std. 12-volt	3	31T	625	2014-08	ALL	4	31T	925					
	10.8L Std. 12-volt	3	31T	925	<b>T270 HYBRID</b>									
	11.1L Opt. 12-volt	2	31T	925	2014-09	ALL	4	31T	925					
	11.1L Opt. 12-volt	3	31T	700										
	11.1L Opt. 12-volt	3	31T	750										
	11.1L Opt. 12-volt	3	31T	900										
	11.1L Opt. 12-volt	4	31T	550										
	11.1L Opt. 12-volt	4	31T	625										
	11.1L Opt. 6-volt	4	4	940										
	11.1L Std. 12-volt	3	31T	625										
	12.7L Opt. 12-volt	2	31T	925										
	12.7L Opt. 12-volt	3	31T	700										
	12.7L Opt. 12-volt	3	31T	750										
	12.7L Opt. 12-volt	3	31T	900										
	12.7L Opt. 12-volt	4	31T	550										

# Trucks

YEAR	ENGINE/ OPTIONS	FOOT NOTE	GROUP/ TYPE NO.	O.E. CCA (@0°F)	YEAR	ENGINE/ OPTIONS	FOOT NOTE	GROUP/ TYPE NO.	O.E. CCA (@0°F)	YEAR	ENGINE/ OPTIONS	FOOT NOTE	GROUP/ TYPE NO.	O.E. CCA (@0°F)
<b>KME (Cont.)</b>					<b>MACK (Cont.)</b>					<b>MITSUBISHI FUSO (Cont.)</b>				
<b>Class 8 Fire/Crash (Cont.)</b>					<b>Medium/Heavy Truck (Cont.)</b>					<b>Medium/Heavy Truck (Cont.)</b>				
<b>Renegade Chassis</b>					<b>MS300T Mid-Liner</b>					<b>FM260</b>				
2014-00	L, 10.3L, 10.8L, 11.1L	5	31T	925	1996-95	ALL	3	31T	660	2007-05	ALL	2	31T	512
1999-95	9.1L, 10.3L, 10.8L, 11.1L	4	31T	950	<b>MARMON</b>					2003-00	ALL	2	31T	512
<b>Class 8 Municipal Snowblower</b>					<b>Class 8 Truck</b>					<b>FM330</b>				
<b>Snow Plow</b>					<b>57P</b>					<b>FM-HR</b>				
2014-00	L, 8.9L, 10.0L, 10.3L, 10.5L, 11.1L	5	31T	925	1998-95	ALL	3	31T	625	2011-05	ALL	2	31T	512
1999-95	10.0L, 10.5L, 11.1L	4	31T	950	<b>MCI</b>					2003-96	ALL	2	31T	512
<b>KODIAK</b>					<b>Motor Coach Bus Chassis</b>					<b>FM-MR</b>				
<b>Class 8 Municipal Snowblower</b>					<b>D4000</b>					<b>FM-SP</b>				
<b>Truck</b>					<b>D4005</b>					<b>FM-SR</b>				
2014-95	ALL	3	31T	925	2014-09	ALL	2	8D	1350	2004-96	ALL	2	31T	512
<b>MACK</b>					<b>D4500</b>					<b>2004-96 ALL 2 31T 512</b>				
<b>Class 8 Truck</b>					<b>D4500 Hybrid</b>					<b>2004-99 7.5L 2 31T 512</b>				
<b>CH</b>					<b>D4505</b>					<b>1997-96 7.5L 2 31T 512</b>				
2001-97	ALL	3	31T	660	2014-09	ALL	2	8D	1350	<b>MONACO</b>				
<b>CL</b>					<b>J4500</b>					<b>Motor Home Chassis</b>				
2001-97	ALL	3	31T	660	2014-07	ALL	2	8D	1350	<b>RR10S</b>				
<b>DM</b>					<b>MITSUBISHI FUSO</b>					<b>2014-07 ALL 31T 700</b>				
2000-97	ALL	3	31T	660	<b>Medium/Heavy Truck</b>					<b>RR4R</b>				
<b>DMM</b>					<b>Canter FE125</b>					<b>2014-07 ALL 31T 700</b>				
2000-97	ALL	3	31T	660	2013-12	ALL	2	31T	400	<b>RR8R</b>				
<b>Granite</b>					<b>Canter FE160</b>					<b>2014-07 ALL 31T 700</b>				
2014-08	16.1L Optional	3	31T	925	2013-12	ALL	2	31T	400	<b>RR8S</b>				
2014-07	12.8L Optional	3	31T	925	2013-12	ALL	2	31T	400	<b>2014-07 ALL 31T 700</b>				
2014-06	10.8L Optional	3	31T	925	2004-95	ALL	2	31T	400	<b>RR8S</b>				
2014-00	ALL	3	31T	650	2005	ALL	2	31T	400	<b>2014-07 ALL 31T 700</b>				
2007-06	10.8L Bridge Formula	3	31T	750	2011-08	ALL	2	31T	400	<b>RR8S</b>				
	12.0L Bridge Formula	3	31T	750	2007-06	ALL	2	31T	400	<b>2014-07 ALL 31T 700</b>				
2007-00	12.0L Optional	3	31T	925	2011-05	ALL	2	31T	400	<b>S-Series</b>				
2007	12.8L Bridge Formula	3	31T	750	2007-06	ALL	2	31T	400	<b>2014-07 ALL 31T 700</b>				
<b>LE</b>					<b>FE</b>					<b>NABI</b>				
2000-97	ALL	3	31T	650	2004-95	ALL	2	31T	400	<b>Transit Bus Chassis</b>				
<b>MR</b>					<b>FE120</b>					<b>31 LFW</b>				
2000-97	ALL	3	31T	660	2005	ALL	2	31T	400	<b>2014-13 ALL 2 31T 1100</b>				
<b>Pinnacle</b>					<b>FE125</b>					<b>35 LFW</b>				
2014-06	ALL	3	31T	650	2011-08	ALL	2	31T	400	<b>2014-13 ALL 2 31T 1100</b>				
<b>RB</b>					<b>FE140</b>					<b>40 LFW</b>				
2000-97	ALL	3	31T	660	2007-06	ALL	2	31T	400	<b>2014-96 ALL 2 31T 1100</b>				
<b>Terrapro</b>					<b>FE145</b>					<b>NEW FLYER</b>				
2014-07	ALL	3	31T	650	2011-05	ALL	2	31T	400	<b>Transit Bus Chassis</b>				
<b>Titan</b>					<b>FE145CC</b>					<b>D35LF</b>				
2014-08	ALL	3	31T	650	2011-05	ALL	2	31T	400	<b>2014-00 ALL 2 8D 1400</b>				
<b>Titan II</b>					<b>FE180</b>					<b>L Optional 2,69 31T 1950</b>				
2014-09	ALL	3	31T	650	2011-05	ALL	2	31T	400	<b>D35LF Hybrid</b>				
<b>Vision</b>					<b>FE-CA</b>					<b>2014-13 ALL 2 8D 1400</b>				
2007-99	ALL	3	31T	650	2001	ALL	2	31T	400	<b>L Optional 2,69 31T 1950</b>				
<b>Medium/Heavy Truck</b>					<b>FE-HD</b>					<b>D40LF</b>				
<b>CS200P Mid-Liner</b>					<b>FE-SP</b>					<b>2014-00 ALL 2 8D 1400</b>				
2001-95	ALL	3	31T	660	2004-96	ALL	2	31T	400	<b>L Optional 2,69 31T 1950</b>				
<b>CS250P Mid-Liner</b>					<b>FE-SP</b>					<b>D40LF Hybrid</b>				
2000-95	ALL	3	31T	660	2004-96	ALL	2	31T	400	<b>2014-03 ALL 2 8D 1400</b>				
<b>CS300P Mid-Liner</b>					<b>FG</b>					<b>L Optional 2,69 31T 1950</b>				
2001-95	ALL	3	31T	660	2004-98	ALL	2	31T	400	<b>D60LF</b>				
<b>CS300T Mid-Liner</b>					<b>FG140</b>					<b>2014-96 ALL 2 8D 1400</b>				
1997-95	ALL	3	31T	660	2011-05	ALL	2	31T	400	<b>L Optional 2,69 31T 1950</b>				
<b>MS200P Mid-Liner</b>					<b>FH</b>					<b>D60LF Hybrid</b>				
2001-95	ALL	3	31T	660	2004-95	ALL	2	31T	512	<b>2014-13 ALL 2 8D 1400</b>				
<b>MS250P Mid-Liner</b>					<b>FK</b>					<b>L Optional 2,69 31T 1950</b>				
2001-95	ALL	3	31T	660	2004-95	ALL	2	31T	512	<b>NOVA BUS</b>				
<b>MS300P Mid-Liner</b>					<b>FK200</b>					<b>Transit Bus Chassis</b>				
2001-95	ALL	3	31T	660	2011-05	ALL	2	31T	512	<b>LFS</b>				
<b>2001-95 ALL 3 31T 660</b>					<b>FK260</b>					<b>2014-98 ALL 4 31T 1090</b>				
<b>2001-95 ALL 3 31T 660</b>					<b>FM</b>					<b>LFS Hybrid</b>				
<b>2001-95 ALL 3 31T 660</b>					<b>1995 ALL 2 31T 512</b>					<b>2014-09 ALL 4 31T 1090</b>				
<b>2001-95 ALL 3 31T 660</b>										<b>2014-09 ALL 4 31T 1090</b>				
<b>2001-95 ALL 3 31T 660</b>										<b>2014-13 ALL 4 31T 1090</b>				

# Trucks

YEAR	ENGINE/ OPTIONS	FOOT NOTE	GROUP/ TYPE NO.	O.E. CCA (@0°F)	YEAR	ENGINE/ OPTIONS	FOOT NOTE	GROUP/ TYPE NO.	O.E. CCA (@0°F)	YEAR	ENGINE/ OPTIONS	FOOT NOTE	GROUP/ TYPE NO.	O.E. CCA (@0°F)
<b>OSHKOSH</b>					<b>PETERBILT (Cont.)</b>					<b>PETERBILT (Cont.)</b>				
<b>Class 8 Cement Mixer</b>					<b>Class 8 Truck (Cont.)</b>					<b>Class 8 Truck (Cont.)</b>				
<b>FMC Mixer</b>					<b>362 (Cont.)</b>					<b>587</b>				
2003-99	ALL 12.0L Optional		4D 8D	700 1000	1996-95	12.7L Optional 12.7L Optional 14.0L Optional 14.0L Optional 14.6L Optional 14.6L Optional	4 4 4 4 4 4	31T 4 31T 4 31T 4	925 940 925 940 925 940	2014-10	ALL	4	31T	650
<b>Highland</b>					<b>365</b>					<b>On Highway Conventional</b>				
2014-10	L Optional		8D	1000	2014-07	ALL	4	31T	650	2003-98	11.1L, 12.0L, 12.7L, 14.0L, 14.6L, 15.0L, 15.8L		31T	650
2014-01	ALL		4D	700	<b>367</b>					2003-97	7.2L, 8.3L, 8.9L, 10.3L, 10.8L	4	31T	650
2009-03	11.2L Optional 12.5L Optional		8D 8D	1000 1000	<b>377</b>					1997-96	10.8L Optional 10.8L Optional 11.1L Optional 11.1L Optional 12.7L Optional 12.7L Optional 14.0L Optional 14.0L Optional	4 4 4 4 4 4 4 4	31T 4 31T 4 31T 4 31T 4	925 940 925 940 925 940 925 940
2009-01	10.8L Optional		8D	1000	<b>377 A/E</b>					1997-95	10.3L, 10.8L, 11.1L, 12.0L, 12.7L, 14.0L, 14.6L, 15.0L	4	31T	625
<b>S SERIES</b>					<b>378</b>					<b>Medium/Heavy Truck</b>				
2014-95	ALL L Optional		4D 8D	700 1000	2006-01	10.8L, 11.2L, 12.5L, 15.0L, 15.1L	4	31T	650	<b>200</b>				
<b>Class 8 Fire/Crash</b>					<b>1996-95</b>					<b>2000-95</b>				
<b>Striker</b>					<b>1996-95</b>					<b>5.9L Optional 5.9L Optional 8.3L Optional 8.3L Optional</b>				
2014-11	L Optional		8D	1000	1996-95	10.8L Optional 10.8L Optional 10.8L, 11.1L, 12.7L, 14.0L, 14.6L	4 4 4 4	31T 31T 31T 31T	925 940 925 940	2014-08	ALL	4	31T	650
2014-04	ALL		4D	700	1996-95	10.8L Optional 10.8L, 11.1L, 12.7L, 14.0L, 14.6L	4 4	31T 31T	925 940	<b>210</b>				
2010	15.0L Optional		8D	1000	1996-95	11.1L Optional 11.1L Optional 12.7L Optional 12.7L Optional 14.0L Optional 14.0L Optional 14.6L Optional 14.6L Optional	4 4 4 4 4 4 4 4	31T 4 31T 4 31T 4 31T 4	625 925 940 925 940 940 925 940	2014-07	ALL	4	31T	650
2009-04	15.8L Optional 18.1L Optional		8D 8D	1000 1000	<b>379</b>					<b>270</b>				
<b>TA-3000</b>					<b>2006-03</b>					<b>2003-01</b>				
2003-95	ALL 12.7L Optional		4D 8D	700 1000	2006-03	10.8L, 11.2L, 12.5L, 15.0L, 15.1L	4	31T	650	<b>325</b>				
<b>Class 8 Municipal Snowblower</b>					<b>1996-95</b>					<b>2014-13</b>				
<b>H SERIES</b>					<b>1996-95</b>					<b>330</b>				
2014-95	ALL L Optional		4D 8D	700 1000	1996-95	10.8L Optional 10.8L Optional 10.8L, 11.1L, 12.7L, 14.0L, 14.6L	4 4 4 4	31T 31T 31T 31T	925 940 925 940	2014-07	ALL	4	31T	650
<b>MPT SERIES</b>					<b>382</b>					<b>2003-01</b>				
2014-99	ALL L Optional		4D 8D	700 1000	2014-10	ALL	4	31T	650	<b>325</b>				
<b>P SERIES</b>					<b>384</b>					<b>2014-13</b>				
2014-95	ALL L Optional		4D 8D	700 1000	2014-07	ALL	4	31T	650	<b>330</b>				
<b>PETERBILT</b>					<b>385</b>					<b>2014-07</b>				
<b>Class 8 Truck</b>					<b>2006-03</b>					<b>2014-11</b>				
<b>320</b>					<b>386</b>					<b>337</b>				
2014-03	8.3L, 8.9L, 9.2L, 10.8L, 11.2L, 12.5L	4	31T	650	2014-05	ALL	4	31T	650	<b>337 HYBRID</b>				
1996-95	10.0L Optional 10.0L Optional 8.3L Optional 8.3L Optional 8.3L, 10.0L	4 4 4 4 4	31T 4 31T 4 31T	925 940 925 940 625	2014-05	ALL	4	31T	650	<b>348</b>				
<b>320 Hybrid</b>					<b>387</b>					<b>2014-13</b>				
2014-09	ALL	4	31T	650	2010-03	ALL	4	31T	650	<b>348 HYBRID</b>				
<b>340</b>					<b>388</b>					<b>2014-10</b>				
2009-06	ALL	4	31T	650	2012-07	ALL	4	31T	650	<b>567</b>				
<b>357</b>					<b>389</b>					<b>2013</b>				
2006-03	8.3L, 8.9L, 10.8L, 11.2L, 12.5L, 15.0L, 15.1L, 15.8L	4	31T	650	2014-07	ALL	4	31T	650	<b>PIERCE</b>				
1996-95	10.0L Optional 10.0L Optional 11.1L Optional 11.1L Optional 12.7L Optional 12.7L Optional 14.0L Optional 14.0L Optional 14.6L Optional 14.6L Optional 8.3L Optional 8.3L Optional 8.3L, 10.0L, 11.1L, 12.7L, 14.0L, 14.6L	4 4 4 4 4 4 4 4 4 4 4 4 4	31T 4 31T 4 31T 4 31T 4 31T 4 31T 4 31T	925 940 925 940 925 940 925 940 940 925 940 625	<b>567</b>					<b>Class 8 Fire/Crash</b>				
<b>362</b>					<b>2014-12</b>					<b>Arrow XT</b>				
2010-08	12.9L	4	31T	650	2014-12	ALL	4	31T	650	2014-11	L Optional		8D	1000
2006-03	11.2L, 12.5L	4	31T	650	<b>579</b>					2014-04	ALL	4D	700	
1996-95	10.8L Optional 10.8L Optional 10.8L, 11.1L, 12.7L, 14.0L, 14.6L 11.1L Optional 11.1L Optional	4 4 4 4 4 4	31T 4 31T 31T 31T 4	925 940 625 925 940										

# Trucks

YEAR	ENGINE/ OPTIONS	FOOT NOTE	GROUP/ TYPE NO.	O.E. CCA (@0°F)	YEAR	ENGINE/ OPTIONS	FOOT NOTE	GROUP/ TYPE NO.	O.E. CCA (@0°F)	YEAR	ENGINE/ OPTIONS	FOOT NOTE	GROUP/ TYPE NO.	O.E. CCA (@0°F)
<b>PIERCE (Cont.)</b>					<b>PREVOST (Cont.)</b>					<b>STERLING (Cont.)</b>				
<b>Class 8 Fire/Crash (Cont.)</b>					<b>Motor Coach Bus Chassis (Cont.)</b>					<b>Medium/Heavy Truck (Cont.)</b>				
<b>Arrow XT (Cont.)</b>					<b>H3-45</b>					<b>Bullet 55</b>				
2010	14.8L Optional		8D	1000	2014-99	ALL	4	31T	1090	2010-08	ALL	4	31T	750
2009-07	14.0L Optional		8D	1000	<b>X3-45</b>					<b>L7500</b>				
2009-04	12.5L Optional		8D	1000	2014-10	ALL	4	31T	1090	2010-99	ALL	4	31T	750
2006-04	12.7L Optional		8D	1000	<b>SEAGRAVE</b>					<b>SC7000 Cargo</b>				
<b>Custom</b>					<b>Class 8 Fire/Crash</b>					<b>2002-99 ALL</b>				
2014-13	ALL		4D	700	<b>Concorde</b>					<b>SUTPHEN</b>				
	L Optional		8D	1000	2009-04	ALL	3	31T	750	<b>Class 8 Fire/Crash</b>				
<b>Dash</b>					<b>SPARTAN</b>					<b>Ambassador</b>				
2014-11	L Optional		8D	1000	<b>Class 8 Fire/Crash</b>					<b>2014-04 ALL</b>				
2014-04	ALL		4D	700	<b>Advantage</b>					<b>Imperial</b>				
2010	12.8L Optional		8D	1000	2014-07	ALL	5	31T	925	2014-04	ALL	4	31T	950
	14.8L Optional		8D	1000	<b>Big Easy</b>					<b>Monarch</b>				
2009-07	14.0L Optional		8D	1000	2014-07	ALL	5	31T	925	2014-04	ALL	4	31T	950
2009-04	10.8L Optional		8D	1000	<b>Crash Rescue</b>					<b>Sutphen Chassis</b>				
	12.5L Optional		8D	1000	2006-98	ALL	5	31T	925	2004-95	ALL	4	31T	950
	8.9L Optional		8D	1000	<b>Diamond</b>					<b>THOMAS BUILT</b>				
2006-04	12.7L Optional		8D	1000	2014-07	ALL	5	31T	925	<b>School Bus Chassis</b>				
<b>Enforcer</b>					<b>Fire</b>					<b>SAF-T-LINER HYBRID</b>				
2012-11	L Optional		8D	1000	2006-00	ALL	5	31T	925	2014-13	ALL	3	31T	1100
2012-04	ALL		4D	700	<b>Gladiator</b>					<b>SAF-T-LINER MVP</b>				
2010	12.8L Optional		8D	1000	2014-07	ALL	5	31T	925	2014-02	ALL	3	31T	1100
2009-07	9.3L Optional		8D	1000	<b>Metro Star</b>					<b>UD</b>				
2009-04	8.3L Optional		8D	1000	2014-07	ALL	5	31T	925	<b>Medium/Heavy Truck</b>				
	8.9L Optional		8D	1000	<b>Mountain Star</b>					<b>1200</b>				
2006-04	8.8L Optional		8D	1000	2014-07	ALL	5	31T	925	2004-99	ALL	2	27	625
<b>Impel</b>					<b>Sierra</b>					<b>1300</b>				
2014-13	ALL		4D	700	2014-07	ALL	5	31T	925	2007-05	ALL	2	27	625
	L Optional		8D	1000	<b>Motor Home Chassis</b>					<b>1400</b>				
<b>Lance</b>					<b>K2</b>					<b>2008-95 ALL</b>				
2012-11	L Optional		8D	1000	2014-98	ALL	2	31T	925	<b>1800</b>				
2012-04	ALL		4D	700	<b>K3</b>					<b>2013-11 7.0L</b>				
2010	12.8L Optional		8D	1000	2014-04	ALL	2	31T	925	<b>2004-95 6.9L</b>				
	14.8L Optional		8D	1000	<b>Mountain Master</b>					<b>1800CS</b>				
2009-07	14.0L Optional		8D	1000	2014-98	ALL	2	31T	925	<b>2010-99 ALL</b>				
2009-04	10.8L Optional		8D	1000	<b>STERLING</b>					<b>1800HD</b>				
2006-04	12.7L Optional		8D	1000	<b>Class 8 Truck</b>					<b>2010-05 ALL</b>				
<b>Pierce Chassis</b>					<b>Acterra 8500</b>					<b>2000</b>				
2004-99	10.8L Optional		8D	1000	2008-00	ALL	4	31T	750	<b>2013-98 ALL</b>				
2004-98	7.2L Optional		8D	1000	<b>A-Line</b>					<b>2300</b>				
	8.3L Optional		8D	1000	2010-03	ALL	4	31T	750	<b>2004-95 ALL</b>				
2004-97	14.6L Optional		8D	1000	<b>Cargo</b>					<b>2300DH</b>				
2004-95	ALL		4D	700	2004-03	ALL	4	31T	750	<b>2013-05 ALL</b>				
	12.7L Optional		8D	1000	<b>Condor</b>					<b>2300LP</b>				
2003-95	11.1L Optional		8D	1000	2008-00	ALL	4	31T	750	<b>2013-05 ALL</b>				
	8.7L Optional		8D	1000	<b>Fire Truck</b>					<b>2600</b>				
1998-95	10.0L Optional		8D	1000	2006-03	ALL	4	31T	750	<b>2013-95 ALL</b>				
	14.0L Optional		8D	1000	<b>Sterling On-Highway</b>					<b>3000</b>				
1997-95	10.8L Optional		8D	1000	2003-98	ALL	4	31T	750	<b>2000-95 ALL</b>				
<b>Quantum</b>					<b>Medium Duty</b>					<b>3300</b>				
2014-11	L Optional		8D	1000	<b>Cargo</b>					<b>2013-99 ALL</b>				
2014-04	ALL		4D	700	2002-99	ALL	4	31T	750	<b>VOLVO</b>				
2010	12.8L Optional		8D	1000	<b>Medium/Heavy Truck</b>					<b>Class 8 Truck</b>				
	14.8L Optional		8D	1000	<b>360</b>					<b>On Highway Cab Over</b>				
2009-07	14.0L Optional		8D	1000	2010-07	ALL	4	31T	750	<b>2002-96 ALL</b>				
2009-04	10.8L Optional		8D	1000	<b>Acterra 5500</b>					<b>On Highway Conventional</b>				
2006-04	12.7L Optional		8D	1000	2007-01	ALL	4	31T	750	<b>2002-96 ALL</b>				
<b>Saber</b>					<b>Acterra 6500</b>					<b>On/Off Highway Cab Over</b>				
2014-11	L Optional		8D	1000	2007-01	ALL	4	31T	750	<b>2002-96 ALL</b>				
2014-04	ALL		4D	700	<b>Acterra 7500</b>					<b>On/Off Highway Conventional</b>				
2010	12.8L Optional		8D	1000	2007-01	ALL	4	31T	750	<b>2002-96 ALL</b>				
2009-07	9.3L Optional		8D	1000	<b>Bullet 45</b>					<b>VHD</b>				
2009-04	7.2L Optional		8D	1000	2010-08	ALL	4	31T	750	<b>2014-03 ALL</b>				
	8.3L Optional		8D	1000	<b>Class 8 Fire/Crash</b>					<b>Class 8 Fire/Crash</b>				
	8.9L Optional		8D	1000	<b>Class 8 Fire/Crash</b>					<b>Class 8 Fire/Crash</b>				
2006-04	8.8L Optional		8D	1000	<b>Class 8 Fire/Crash</b>					<b>Class 8 Fire/Crash</b>				
<b>Velocity</b>					<b>Class 8 Fire/Crash</b>					<b>Class 8 Fire/Crash</b>				
2014-13	ALL		4D	700	<b>Class 8 Fire/Crash</b>					<b>Class 8 Fire/Crash</b>				
	L Optional		8D	1000	<b>Class 8 Fire/Crash</b>					<b>Class 8 Fire/Crash</b>				
<b>PREVOST</b>					<b>Class 8 Fire/Crash</b>					<b>Class 8 Fire/Crash</b>				
<b>Motor Coach Bus Chassis</b>					<b>Class 8 Fire/Crash</b>					<b>Class 8 Fire/Crash</b>				
<b>H3-41</b>					<b>Class 8 Fire/Crash</b>					<b>Class 8 Fire/Crash</b>				
2014-99	ALL	4	31T	1090	<b>Class 8 Fire/Crash</b>					<b>Class 8 Fire/Crash</b>				

# Trucks

YEAR	ENGINE/ OPTIONS	FOOT NOTE	GROUP/ TYPE NO.	O.E. CCA (@0°F)	YEAR	ENGINE/ OPTIONS	FOOT NOTE	GROUP/ TYPE NO.	O.E. CCA (@0°F)	YEAR	ENGINE/ OPTIONS	FOOT NOTE	GROUP/ TYPE NO.	O.E. CCA (@0°F)
<b>VOLVO (Cont.)</b>					<b>WESTERN STAR (Cont.)</b>					<b>WORKHORSE (Cont.)</b>				
<b>Class 8 Truck (Cont.)</b>					<b>Class 8 Truck (Cont.)</b>					<b>Medium/Heavy Truck (Cont.)</b>				
<b>VN</b>					<b>On Highway (Cont.)</b>					<b>P32 (Cont.)</b>				
2014-01	ALL	4	31T	950	2000	12.7L Optional	54	8D	1300	2003-99	6.5L	2	78	600
<b>VNL</b>										<b>P42</b>				
2014-04	ALL	4	31T	950						2005-99	6.5L 7.4L	2	78 78	600 690
<b>VNM</b>					<b>On Highway Conventional</b>					<b>R26</b>				
2014-04	ALL	4	31T	950	2001-97	ALL	3	31T	625	2009-07	ALL		78	690
<b>VNX</b>										<b>R32</b>				
2014-13	ALL	4	31T	950						2009-03	ALL		78	690
<b>VT</b>										<b>W16</b>				
2009-04	ALL	4	31T	950						2009-06	ALL		78	690
<b>WC</b>										<b>W18</b>				
1996-95	ALL	4	31T	550						2009-06	ALL		78	690
	10.0L Optional	3	31T	625						<b>W20</b>				
	10.8L Optional	3	31T	625						2009-01	ALL		78	690
	11.1L Optional	3	31T	625						<b>W21</b>				
	12.7L Optional	3	31T	625						2009-07	ALL		78	690
	14.0L Optional	3	31T	625						<b>W22</b>				
	14.6L Optional	3	31T	625						2009-01	ALL		78	690
<b>WG</b>										<b>W24</b>				
1997-95	ALL	4	31T	550						2009-04	ALL		78	690
	10.0L Optional	3	31T	625						<b>W25</b>				
	10.8L Optional	3	31T	625						2009-05	ALL		78	690
	11.1L Optional	3	31T	625						<b>W42</b>				
	12.1L Optional	3	31T	625						2011-05	4.5L, 4.8L		78	690
	12.7L Optional	3	31T	625						2004	6.5L	2	78	600
	14.0L Optional	3	31T	625						<b>W62</b>				
	14.6L Optional	3	31T	625						2011-07	ALL		78	690
<b>WH</b>														
1996-95	ALL	4	31T	550										
	10.0L Optional	3	31T	625										
	10.8L Optional	3	31T	625										
	11.1L Optional	3	31T	625										
	12.7L Optional	3	31T	625										
	14.0L Optional	3	31T	625										
	14.6L Optional	3	31T	625										
<b>WI</b>														
1996-95	ALL	4	31T	550										
	10.0L Optional	3	31T	625										
	10.8L Optional	3	31T	625										
	11.1L Optional	3	31T	625										
	12.7L Optional	3	31T	625										
	14.0L Optional	3	31T	625										
	14.6L Optional	3	31T	625										
<b>WX</b>														
1996-95	ALL	4	31T	550										
	10.0L Optional	3	31T	625										
	10.8L Optional	3	31T	625										
	11.1L Optional	3	31T	625										
	12.7L Optional	3	31T	625										
	14.0L Optional	3	31T	625										
	14.6L Optional	3	31T	625										
<b>WESTERN STAR</b>														
<b>Class 8 Truck</b>														
<b>On Highway</b>														
2001-00	ALL	3	31T	625										
	14.6L Optional	3	31T	750										
	14.6L Optional	4	31T	700										
	14.6L Optional	54	31T	1000										
	14.6L Optional	54	8D	1300										
2000	10.3L Optional	3	31T	750										
	10.3L Optional	4	31T	700										
	10.3L Optional	54	31T	1000										
	10.3L Optional	54	8D	1300										
	11.1L Optional	3	31T	750										
	11.1L Optional	4	31T	700										
	11.1L Optional	54	31T	1000										
	11.1L Optional	54	8D	1300										
	12.0L Optional	3	31T	750										
	12.0L Optional	4	31T	700										
	12.0L Optional	54	31T	1000										
	12.0L Optional	54	8D	1300										
	12.7L Optional	3	31T	750										
	12.7L Optional	4	31T	700										
	12.7L Optional	54	31T	1000										
<b>WORKHORSE</b>														
<b>Medium/Heavy Truck</b>														
<b>LF72</b>														
2011-05	ALL							78	690					
<b>P32</b>														
2005-99	5.7L, 7.4L, 8.1L							78	690					



# Farm Equipment

YEAR	ENGINE/ OPTIONS	FOOT NOTE	GROUP/ TYPE NO.	O.E. CCA (@0°F)	YEAR	ENGINE/ OPTIONS	FOOT NOTE	GROUP/ TYPE NO.	O.E. CCA (@0°F)	YEAR	ENGINE/ OPTIONS	FOOT NOTE	GROUP/ TYPE NO.	O.E. CCA (@0°F)
<b>CASE NEW HOLLAND (Cont.)</b>					<b>CATERPILLAR (Cont.)</b>					<b>CHALLENGER (Cont.)</b>				
Tractors - Mechanical Front Wheel Drive (Cont.)					Combines (Cont.)					Tracked Ag Tractors (Cont.)				
T2320, T2330, T2410, T2420					LEXION 590R					MT735, MT745, MT755, MT765				
2008-07			31T	420	2010-04			4D	1100	2004-02		2	31T	950
T8010, T8020, T8030, T8040					LEXION 595R					MT745B, MT755B, MT765B				
2010-06		2	31T	1000	2010-05			4D	1100	2008-05		2	31T	950
T8050					LEXION 670 STRAW, LEXION 730, LEXION 740					MT755C, MT765C				
2010-07		2	31T	1000	2014-10			4D	1100	2011-08		2	31T	950
TS6000, TS6020, TS6030					LEXION 740TT, LEXION 750, LEXION 750TT					MT755D, MT765D				
2014-08			31T	950	2014-10			4D	1100	2014-12		2	49	730
TT75					LEXION 760, LEXION 760TT, LEXION 770					MT835, MT845, MT855, MT865				
2014-05			31T	950	2014-10			4D	1100	2004-02		4	31T	950
Windrowers					LEXION 770TT					MT835B, MT845B, MT855B, MT865B, MT875B				
H8040, H8040 PRAIRIE SPECIAL, WD1203					2014-10					2008-05				
2014-07			31T	925	<b>CHALLENGER</b>					MT835C, MT845C, MT855C, MT865C, MT875C				
H8060, H8080					660B, 670B					2014-08				
2014-07		2	31T	650	2011-08					Tractors - 4WD Articulated				
HW300, HW320					680B					MT945C, MT955C, MT965C, MT975C				
2004-98			31T	700	2011-06					2014-08				
HW305, HW305S, HW325					Self Propelled Sprayers					2014-08				
2007-04			31T	700	ROGATOR 994, ROGATOR 994H					Tractors - Mechanical Front Wheel Drive				
2004-98		2	31T	700	2014-06					MT515D, MT525D, MT535D, MT545D, MT555D				
HW345					ROGATOR 1194, ROGATOR 1194H					2014-12				
2007-04		2	31T	700	2014-06					MT565D, MT575D, MT585D				
HW365					ROGATOR 1396, SPRA-COUPÉ 7460					2014-12				
2006-04		2	31T	700	2014-06					MT645D, MT655D, MT665D, MT675D, MT685D				
WD1903, WD2303					SPRA-COUPÉ 4460, SPRA-COUPÉ 4660					2014-12				
2014-07		2	31T	925	2014-06					MT945B, MT955B, MT965B, MT975B				
WDX901, WDX1101					SPRA-COUPÉ 7660					2008-06				
2004-01			31T	925	2014-06					Windrowers				
WDX1002S, WDX1202S					TERRA-GATOR 6303, TERRA-GATOR 8204					CHALLENGER SP11, CHALLENGER SP16				
2006-04			31T	925	2011-06					2003-02				
WDX1202					TERRA-GATOR 8303, TERRA-GATOR 9203					2003-02				
2007-04			31T	925	2011-06					CHALLENGER SP80				
WDX1203					TERRA-GATOR TG7300, TERRA-GATOR TG8300					2003-02				
2007			31T	925	2014-11					CHALLENGER SP85B				
WDX1701					TERRA-GATOR TG8400					2006-04				
2004-01		2	31T	925	2014-11					CHALLENGER SP115B				
WDX1902, WDX2302					TERRA-GATOR TG9300					2008-04				
2007-04		2	31T	925	2014-11					CHALLENGER SP115C, CHALLENGER SP185C				
WDX1903, WDX2303					Tracked Ag Tractors					2011-08				
2007		2	31T	925	CHALLENGER 35, CHALLENGER 45					CHALLENGER SP185B				
<b>CATERPILLAR</b>					2002-98					2008-04				
Combines					CHALLENGER 55					WR9740, WR9760, WR9770				
LEXION 160, LEXION 470, LEXION 475					2002-98					2014-11				
2001			4D	1100	2002-98					FIAT TRACTORS				
LEXION 450, LEXION 460					CHALLENGER 65					Tractors				
2004-01			4D	1100	2002-95					640				
LEXION 460R, LEXION 470R, LEXION 475R					CHALLENGER 65C					2004-02				
2004-02			4D	1100	1997-95					4DLT				
LEXION 465					CHALLENGER 65D					820				
2002-01			4D	1100	1999-95					<b>FORD NEW HOLLAND</b>				
LEXION 480, LEXION 485					CHALLENGER 65E, CHALLENGER 75E					Farm				
2001			4D	1100	2000-98					1120, 1220, 1320, 1520, 1720				
LEXION 480R, LEXION 485R					CHALLENGER 70					1997-95				
2004-02			4D	1100	1996-95					24				
LEXION 560 STRAW					CHALLENGER 75					1920, 2120				
2007-04			4D	1100	2002-95					1997-95				
LEXION 560R, LEXION 570R, LEXION 575R					CHALLENGER 75B					3220, 3230				
2009-04			4D	1100	1999-95					1997-95				
LEXION 570 STRAW					CHALLENGER 75C, CHALLENGER 75D					5610, 6610				
2010-06			4D	1100	1997-95					1996-95				
LEXION 580R					CHALLENGER 85					4DLT				
2009-04			4D	1100	2002-95					750				
LEXION 585R					CHALLENGER 95					5640, 6640, 7740, 7840, 8240, 8340				
2009-05			4D	1100	2002-97					1996-95				
					CHALLENGER 95D, CHALLENGER 95E					7610, 8010				
					2000-95					2000-98				
					2,43					30H				
					31T					600				
					950					9782				
					950					2000-98				
					2,43					3				
					31T					31T				
					950					750				
					2,43					HW300, HW320				
					31T					2000-98				
					950					31T				
					950					925				
					2,43					HW340				
					31T					2000-98				
					950					31T				
					950					625				

# Farm Equipment

YEAR	ENGINE/ OPTIONS	FOOT NOTE	GROUP/ TYPE NO.	O.E. CCA (@0°F)	YEAR	ENGINE/ OPTIONS	FOOT NOTE	GROUP/ TYPE NO.	O.E. CCA (@0°F)	YEAR	ENGINE/ OPTIONS	FOOT NOTE	GROUP/ TYPE NO.	O.E. CCA (@0°F)
<b>FORD NEW HOLLAND (Cont.)</b>					<b>HESSTON CO (Cont.)</b>					<b>J.I. CASE &amp; CASE IH (Cont.)</b>				
Farm (Cont.)					Farm (Cont.)					Self Propelled Sprayers (Cont.)				
<b>TS100</b>					<b>100-90 (Cont.)</b>					<b>PATRIOT 3230, PATRIOT 3330</b>				
2000-98			31T	800	1996		2	4DLT	820	2014-06		2	31T	950
Tractors - 2-Wheel Drive					<b>8500</b>					PATRIOT 4420				
<b>3010</b>					1997-95					2011-06				
2003-96			30H	600	<b>8510</b>					2				
Tractors - Mechanical Front Wheel Drive					2000-98					PATRIOT 4430				
<b>9482</b>					Windrowers					2014-11				
1999-96		3	31T	750	<b>8400</b>					2				
<b>GLEANER</b>					1997-95					Skid Steer				
Combines					<b>8450</b>					400 Series				
<b>A65, A75</b>					2004-97					2007-06				
2008-06		2	31T	950	<b>8550S</b>					31T				
<b>A66, A76, R66, R76</b>					2004-99					Tractors				
2011-08		2	31T	950	<b>8550</b>					DX Series Compact, DXE Series Sub-Compact				
<b>A85</b>					<b>J.I. CASE &amp; CASE IH</b>					2008-06				
2008-06		3	31T	950	Combines					31T				
<b>A86</b>					2144, 2166, 2188					JX 110U, JX 1080U, JX 1090U				
2011-08		2	31T	950	1998-95					2004-03				
<b>GLS67, GLS77, S67, S77</b>					2344					JX Series				
2014-10		3	31T	950	2002-98					2007-06				
<b>R42</b>					2366, 2388					2002				
2002-01	S/N -48000	2	24	580	2003-98					31T				
2002-01	S/N 48001-	2	31T	950	<b>2377</b>					31T				
<b>R52</b>					2005-04					Tractors - 2-Wheel Drive				
2002-01	S/N -58000	2	24	580	<b>AF 2577, AF 2588, AF 7010, AF 8010</b>					C50, C60, C70, C80, CX50, CX60, CX70, CX80				
2002-01	S/N 58001-	2	31T	950	2008-06					2002-97				
<b>R55</b>					<b>AF 5088, AF 6088, AF 7088, AF 7120, AF 8120</b>					58				
2006-02		2	31T	950	2011-08					31T				
<b>R62</b>					<b>AF 5130, AF 6130, AF 7130, AF 7230, AF 8230</b>					C90, C100, CX90, CX100				
2002-01	S/N -68000	2	24	580	2014-11					2002-97				
2002-01	S/N 68001-	2	31T	950	<b>AF 9120</b>					31T				
<b>R65, R75</b>					2011-08					D35, DX48				
2008-02		2	31T	950	<b>AF 9230</b>					2006-03				
<b>R72</b>					2014-11					D40, DX55				
2002-01	S/N -78000	2	24	580	<b>AFX 2366</b>					2008-03				
2002-01	S/N 78001-	2	31T	950	2004					2006-04				
<b>GRAVELY</b>					<b>AFX 2377, AFX 2388</b>					DX35, DX40				
Tractors - 2-Wheel Drive					2005-04					2004-03				
<b>PROFESSIONAL</b>					<b>AFX 2577, AFX 2588, AFX 7010</b>					JX95				
2014-09			U1	340	2008					2014-08				
<b>GVM</b>					<b>AFX 8010</b>					MX135				
Self Propelled Sprayers					2006-04					2002-98				
<b>PREDATOR 6215, PREDATOR 8275</b>					Compact Tractors					58				
2014-08			31T	850	DX Series					31T				
<b>PROWLER 9275</b>					2002					MXM 120, MXM 130, MXM 140, MXM 155				
2014-08			31T	850	Cotton Picker					2005-02				
<b>PROWLER E325</b>					2155					MXM 175, MXM 190, MXM Series				
2014-11			31T	850	1997-95					2005-02				
<b>PROWLER E350</b>					2555					Tractors - Mechanical Front Wheel Drive				
2014-09			31T	850	2003-97					9210, 9230, 9240, 9250, 9280				
<b>HAGIE</b>					<b>CPX 420, CPX 620</b>					1995				
Harvesters					2007-06					3				
<b>204 DETASSELER, 204SP DETASSELER</b>					Farm					9310				
2014-06			31T	900	<b>4260</b>					1996-95				
<b>Self Propelled Sprayers</b>					5220, 5230, 5240, 5250					2,58				
<b>DTS10, STS10, STS10T, STS12, STS14, STS16</b>					2000-98					31T				
2014-08			31T	900	2000-95					9330, 9350, 9370, 9380				
<b>STX10</b>					C101					1999-95				
2014-08			31T	900	MX80, MX90					2,58				
<b>HESSTON CO</b>					<b>Self Propelled Sprayers</b>					C50, C60, C70, C80, CX50, CX60, CX70, CX80				
Farm					<b>FLX 3300B, FLX 3330B, FLX 4300, FLX 4330</b>					2002-97				
<b>100-90</b>					2005-99					58				
2005-95			4DLT	820	2005-99					31T				
2000-99		2	4DLT	820	<b>FLX 4375</b>					C90, C100, CX90, CX100				
					2005-99					2002-97				
					2					D35, D45, DX40, DX45, DX55				
					31T					2008-03				
					2					D40, DX48				
					31T					2006-03				
					2					DX18E, DX22E, DX25E, DX34				
					31T					2008-06				
					2					DX21, DX24, DX29, DX33				
					30H					2005-03				
					31T					DX23E				
					31T					2006-05				
					31T					DX26				
					31T					2007-05				
					31T					DX31				
					31T					2008-05				
					31T					DX35				
					31T					2007-03				
					31T					660				

# Farm Equipment

YEAR	ENGINE/ OPTIONS	FOOT NOTE	GROUP/ TYPE NO.	O.E. CCA (@0°F)	YEAR	ENGINE/ OPTIONS	FOOT NOTE	GROUP/ TYPE NO.	O.E. CCA (@0°F)	YEAR	ENGINE/ OPTIONS	FOOT NOTE	GROUP/ TYPE NO.	O.E. CCA (@0°F)
<b>J.I. CASE &amp; CASE IH (Cont.)</b>					<b>JOHN DEERE (Cont.)</b>					<b>JOHN DEERE (Cont.)</b>				
Tractors - Mechanical Front Wheel Drive (Cont.)					Combines (Cont.)					Cotton Picker (Cont.)				
<b>DX60</b>					<b>1450</b>					<b>9970, 9976</b>				
2008-07			31T	660	2014-00			5D	1400	2003-98		2	31T	950
<b>JX80, JX95</b>					<b>1550</b>					<b>9986</b>				
2014-08			31T	950	2014-01			5D	1400	2010-02		2	31T	950
<b>MAGNUM 180</b>					<b>9400</b>					<b>9996</b>				
2014-09			31T	660	1998-95		2	27	650	2010-04		2	31T	925
<b>MAGNUM 190, MAGNUM 210, MAGNUM 225</b>					<b>9410</b>					Cotton Stripper				
2012-09			31T	660	2000-98		2	27	650	<b>7450</b>				
<b>MAGNUM 215, MAGNUM 245, MAGNUM 275</b>					<b>9450 Cylinder/Walker, 9550 Cylinder/Walker</b>					1996-95				
2010-06			31T	660	2003-99		2	27	650	<b>7455</b>				
<b>MAGNUM 235, MAGNUM 260, MAGNUM 290</b>					<b>9500</b>					2003-97				
2012-11			31T	660	1998-95		2	27	620	<b>7460</b>				
<b>MAGNUM 240, MAGNUM 280, MAGNUM 310</b>					1998-95 Sidehill					2014-04				
2014-13			31T	950	<b>9510, 9610</b>					Farm				
<b>MAGNUM 305</b>					2000-98					2355, 2355N, 2555				
2010-06			31T	660	<b>9550 Sidehill, 9650 Cylinder Tine Separator</b>					1995				
<b>MAGNUM 305 GOLD SP. ED.</b>					2003-99					2				
2007			31T	660	<b>9560 Cylinder/Walker</b>					2550				
<b>MAGNUM 315</b>					2004-02					2009-05 w/SGB				
2012-11			31T	950	<b>9560 Sidehill, 9660 Cylinder Tine Separator</b>					2				
<b>MAGNUM 335</b>					2004-03					2955				
2010-07			31T	950	<b>9560 STS, 9660 Single Tine Separator, 9760 STS</b>					1995				
<b>MAGNUM 340</b>					2007-03					3155				
2014-11			31T	950	<b>9570 STS</b>					1995				
<b>MAGNUM 380</b>					2011-07					3325, 3365				
2014-13			31T	950	<b>9600</b>					1995				
<b>MX100, MX100 MAXXUM, MX120</b>					1998-95					6100				
2002-97	58		31T	1000	<b>9650 Cylinder/Walker</b>					2000-96				
<b>MX110, MX110 MAXXUM</b>					2003-99					6200				
2002-97	2,58		31T	1000	<b>9650 Single Tine Separator, 9750 Tine Separator</b>					1998-95				
<b>MX120 MAXXUM, MX130, MX135 MAXXUM</b>					2003-99					6300				
2002-97	58		31T	1000	<b>9650, 9750</b>					1998-95				
<b>MX150, MX170, MX180, MX200</b>					2014-02					6600				
2002-99	2,58		31T	1000	<b>9660 Cylinder/Walker</b>					2000-95				
<b>MX210, MX230, MX255, MX285, MXM 120</b>					2005-03					7200, 7400				
2005-02			31T	660	<b>9660 WTS</b>					1998-95				
<b>MX215, MX275, MXM 140, MXM 155</b>					2006-05					7445				
2014-08			31T	660	<b>9670 STS, 9770 STS</b>					1996-95				
<b>MX220, MX240, MX270</b>					2011-07					Harvesters				
2002-99			31T	660	<b>9860 STS</b>					6610				
<b>MX245, MX305</b>					2007-03 SN -078555					1998-95				
2006			31T	660	2007-03 SN 078556-					6650, 6750				
<b>MXM 130, MXM 140, MXM 155, MXM 175</b>					<b>9870 STS</b>					2003-98				
2005-02			31T	660	2011-07 SN -078555					6710				
<b>MXM 190, MXM Series</b>					2011-07 SN 078556-					2006-95				
2005-02			31T	660	<b>S550, S660</b>					6810, 6910				
<b>Windrowers</b>					2014-11					2006-95				
<b>8825</b>					<b>S670, S680</b>					6850, 6950				
1999-95		2	24F	600	2014-11					2003-98				
<b>8825HP</b>					<b>S690</b>					Hi-Cycle Sprayer				
2001-00		2	24F	600	2014-11					6000				
<b>8830</b>					Corn Head					1998-95				
1999-95 Diesel		2	24F	600	2004-02					Riding Reel Mowers				
1999-95 Gas			24F	420	<b>90 Series (27 - 40hp)</b>					2653A				
<b>8840, 8850</b>					Cotton Picker					2008-04				
1999-95		2	24F	600	<b>7660</b>					2003-95				
<b>8860, 8870, 8880</b>					2014-10					Self Propelled Sprayers				
2001-99			24T	500	3					4630, 4760, 4830				
<b>JOHN DEERE</b>					2014-08					2014-07				
<b>Combines</b>					<b>9930</b>					<b>4710 (800 gal)</b>				
<b>1165, 1175</b>					2003-95					2004-02				
2014-95			5D	1400	31T					4930				
<b>1185</b>					1998-95					2011-06				
1998-95			5D	1400	Optional					4940				
<b>1195</b>					2014-04					2014-11				
2001-98			5D	1400	Optional					Sugar Cane Harvester				
					2014-04					<b>3510</b>				
					2014-04					2008-06				

# Farm Equipment

YEAR	ENGINE/ OPTIONS	FOOT NOTE	GROUP/ TYPE NO.	O.E. CCA (@0°F)	YEAR	ENGINE/ OPTIONS	FOOT NOTE	GROUP/ TYPE NO.	O.E. CCA (@0°F)	YEAR	ENGINE/ OPTIONS	FOOT NOTE	GROUP/ TYPE NO.	O.E. CCA (@0°F)
<b>JOHN DEERE (Cont.)</b>					<b>JOHN DEERE (Cont.)</b>					<b>JOHN DEERE (Cont.)</b>				
Sugar Cane Harvester (Cont.)					Tractors - 2-Wheel Drive (Cont.)					Tractors - 2-Wheel Drive (Cont.)				
<b>3520</b>					<b>4710</b>					<b>8100, 8200, 8300, 8400</b>				
2014-08		2	31T	925	2004-02			48	690	1999-95		2,58	31T	950
Track Harvester					<b>5105, 5205</b>					<b>8110, 8210, 8310, 8410</b>				
<b>753G</b>					2007-99					2001-99				
2008-01		2	31T	950	2007-99 Optional					<b>8225R, 8345R</b>				
Tracked Ag Tractors					<b>5200, 5300, 5400</b>					2011-09				
<b>8100T, 8200T, 8300T, 8400T</b>					1998-95 Optional w/o Cab					Tractors - 4WD Articulated				
1999-97		2	31T	925	1998-95 w/Cab					<b>9100, 9400</b>				
<b>8110T, 8210T, 8310T, 8410T</b>					1998-95 w/o Cab					2001-96				
2001-99		2	31T	925	<b>5210, 5310, 5410, 5510</b>					<b>9120, 9220, 9320, 9420, 9520</b>				
<b>8120T, 8220T, 8320T, 8420T</b>					2000-98					2007-01				
2005-01		2	31T	925	2000-98 Optional					<b>9200</b>				
<b>8230T, 8330T, 8430T</b>					<b>5220, 5320, 5420, 5520</b>					2001-96				
2009-05		2	31T	925	2004-01					<b>9230</b>				
<b>8295RT, 8320RT, 8345RT</b>					<b>5303</b>					2011-07				
2011-09		2	31T	925	2010-08					<b>9300</b>				
<b>8310RT, 8335RT, 8360RT</b>					<b>5403</b>					2001-96				
2013-11		2	31T	925	2014-02					58				
<b>8520T</b>					<b>5415, 5615, 5715, 6403, 6603</b>					<b>9330, 9430, 9530, 9630</b>				
2005-02		2	31T	925	2014-02					3				
<b>9300T, 9400T</b>					<b>5425, 5425N, 5625, 5725</b>					<b>9360R, 9410R, 9460R, 9510R, 9560R</b>				
2001-99		3	31T	925	2014-06					2014-12				
<b>9320T, 9420T</b>					<b>5500</b>					<b>9620</b>				
2007-01		3	31T	925	1998-96 Optional w/o Cab					2007-04				
<b>9430T, 9530T, 9630T</b>					1998-96 w/Cab					Tractors - Compact Utility				
2011-07		3	31T	925	1998-96 w/o Cab					<b>670</b>				
<b>9460RT, 9510RT, 9560RT</b>					2001-95					1997-95				
2014-12		3	31T	925	<b>6500</b>					<b>770</b>				
<b>9460T</b>					2000-96					1998-95				
2009-07		2	27	650	1998-96					<b>970, 1070</b>				
<b>9520T</b>					<b>7130, 7130 Premium, 7230, 7230 Premium, 7330</b>					1998-95				
2007-02		3	31T	925	2011-06					<b>5103, 5203</b>				
<b>9620T</b>					2011-06					2008-03				
2007-04		3	31T	925	<b>7200R, 7215R, 7230R, 7260R, 7280R, 8235R</b>					Tractors - Mechanical Front Wheel Drive				
Tractors					2013-11					<b>990</b>				
<b>4020 (43 - 58hp)</b>					<b>7210, 7410</b>					2008-05				
2004-02			3ET	620	2001-95					<b>1023E, 1026R</b>				
Tractors - 2-Wheel Drive					2006-02					2014-11				
<b>755</b>					2006-02					<b>2305</b>				
1999-95			22F	490	<b>7330 Premium</b>					2011-05				
<b>790</b>					2011-06					<b>2320</b>				
2008-98			22NF	500	<b>7330 Premium, 7430 Premium</b>					2012-06				
<b>855</b>					2011-06					<b>2520</b>				
1999-95	S/N -615000		22F	490	<b>7405</b>					2006-05 Diesel				
1999-95	S/N 615001-		45	500	2001-97					2006-05 Gas & LP				
<b>955</b>					<b>7430</b>					<b>2720</b>				
1999-95			45	500	2008-06					2014-08				
<b>990</b>					<b>7510</b>					<b>3005</b>				
2008-99			27F	650	2001-98					2012-09				
<b>4100</b>					<b>7520</b>					<b>3032E, 3038E</b>				
2000-97			51	435	2006-02 Diesel					2014-09				
<b>4200, 4400</b>					<b>7530 Premium</b>					<b>3120</b>				
2000-99			22NF	500	2011-09					2010-05				
<b>4210</b>					2011-09					<b>3203</b>				
2005-01			22NF	500	<b>7610, 7710</b>					2009-06				
<b>4300</b>					2003-95					<b>3320, 3520, 3720</b>				
2000-99			22F	500	<b>7630 Large Frame, 7730 Large Frame</b>					2014-05				
<b>4310</b>					2010-06					<b>4005</b>				
2004-01			22NF	500	<b>7720, 7820, 7920</b>					2012-09				
<b>4455</b>					2006-03					<b>4010, 4110</b>				
1996-95		2	31T	950	<b>7800</b>					2005-01				
<b>4500, 4600</b>					1995					<b>4100</b>				
2000-99			27F	650	<b>7810</b>					2002-99				
<b>4510, 4610</b>					2003-96					<b>4105</b>				
2004-01			48	690	<b>7830 Large Frame, 7930 Large Frame</b>					2014-07				
					2010-06					2005-01				

# Farm Equipment

YEAR	ENGINE/ OPTIONS	FOOT NOTE	GROUP/ TYPE NO.	O.E. CCA (@0°F)	YEAR	ENGINE/ OPTIONS	FOOT NOTE	GROUP/ TYPE NO.	O.E. CCA (@0°F)	YEAR	ENGINE/ OPTIONS	FOOT NOTE	GROUP/ TYPE NO.	O.E. CCA (@0°F)
<b>JOHN DEERE (Cont.)</b>					<b>JOHN DEERE (Cont.)</b>					<b>MAC DON INDUSTRIES LTD.</b>				
Tractors - Mechanical Front Wheel Drive (Cont.)					Tractors - Mechanical Front Wheel Drive (Cont.)					Windrowers				
4120, 4320, 4520, 4720					8970					3020 Pull Type				
2014-04			34	770	1998-95		3	31T	950	2008-05			27	620
4200, 4400					Tractors - Utility					9250				
2000-99			22NF	500	2210					2007-95			27	620
4300					2006-03					9350				
2000-99			22F	500	Wheeled Harvester					2003-95				
4310, 4410					1070D					9350C				
2004-01			22NF	500	2008-02		2	31T	950	2006-05				
4500, 4600, 4700					Windrowers					9352				
2000-99			27F	650	3430, 3830					2003-02				
4510, 4610, 4710					1996-95					9352i				
2004-01			48	690	A400					2006-03				
5045D, 5045E					2012-09					M100				
2014-09			27	650	D450					2011-08				
5055D, 5055E, 5075E					2014-11					M105, M155				
2012-09			27	650	R450					2014-11				
5065E					2014-09					M150				
2014-11			27	650	W110, W150					2011-07				
5065M, 5075M, 5085M, 6100D, 6130D, 6140D					2014-13					M200				
2014-09			31T	925	Windrowers - Self Propell					2010-07				
5083E Limited, 5093E Limited, 5095M					4890					M205				
2011-09			31T	925	2001-96		2	24	550	2014-10				
5083E, 5100M, 5101E, 5115M					4895					MASSEY-FERGUSON				
2014-11			31T	925	2009-01			31T	925	Combines				
5093E					4990					9690, 9790				
2014-12			31T	925	2002-99	S/N -163100	2	24	550	2008-01				
5101E Limited, 5105M					2002-99					9695, 9795				
2011-09			31T	925	4995					2011-08				
5210, 5310, 5410, 5510					2009-02					9895				
2000-98			31T	700	<b>KIOTI</b>					2011-06				
2000-98	Optional		31T	925	Tractors					Compact Tractors				
5225, 5325, 5425, 5525					CK20, CK20HST, LB1914					1165 Compact Tractor				
2008-04			31T	925	2008-05			24	450	2005				
5625					CK30					Farm				
2008-07			31T	925	2008-05			24	675	MF 240, MF 250				
6110D, 6115D, 6125D, 7425 SERIES					DK Series					1998-95				
2014-08			31T	925	2008-06			24	450	MF 394F, MF 394S				
6110J, 6140J, 6155J, 6425J					LK 3054X5, LK2554					2000-95				
2014-10			31T	925	2007-05			24	450	MF 1230				
6140R, 6150R, 6170R, 6190R, 6210R					<b>KORVAN CORPORATION</b>					1998-95				
2014-12			4D	1150	Harvesters					MF 3245, MF 3260, MF 3270, MF 3280				
7200R, 7215R, 7230R, 7260R, 7280R, 8235R					930 R, 9000 R, 9800 R					1999-98				
2013-11		2	31T	925	2007-06			25	660	MF 4270				
7210, 7410, 7610					2004-02					2000-97				
2000-96		2,58	31T	925	Olive Harvester					MF 8785				
7510					5000					1998-95				
2000-98		2,58	31T	925	2006-00			25	660	Swathers				
7525 SERIES					Raisin Harvester					MF 9220				
2014-08			31T	925	2000					2011-05				
7710					2006-04					MF 9420				
2003-96		2,58	31T	925	2007-06			25	660	2007-05				
7720, 7820, 7920					3016					Tractors				
2006-03		2	31T	925	2007-06			25	660	1200 Series, MF 1205 - 4, MF 1215 - 2/4				
7810					Raspberry/Blueberry Harvester					2005				
2001-96		2,58	31T	925	2004-02			25	660	4300 Series Low Profile, 6200 Series, 8200 Series				
8100, 8200, 8300, 8400					8000					2004-02				
1999-96		2,58	31T	950	2006-96			25	660	GC 2300, MF 220XL, MF 1455 - 4				
8110, 8210, 8310, 8410					<b>LONG MFG. N.C. INC.</b>					2005				
2001-99		2	31T	925	Farm					MF 27XE - 2/4WD, MF 251XE - 2/4WD				
8120, 8220, 8320, 8420, 8520					360					2004-02				
2005-01		2	31T	925	1996			4EH	850	MF 243, MF 263				
8130, 8230, 8330, 8430, 8530					2260, 2310, 2360, 2460, 2510, 2610					2000-97				
2009-05		2	31T	925	1997-95			30H	650	MF 281XE - 4WD, MF 451 - 2/4WD				
8260R, 8285R, 8310R, 8335R, 8360R										2004-02				
2013-11		2	31T	925						27F				
8570, 8770, 8870										27F				
1998-95		2	31T	950						575				

# Farm Equipment

YEAR	ENGINE/ OPTIONS	FOOT NOTE	GROUP/ TYPE NO.	O.E. CCA (@0°F)	YEAR	ENGINE/ OPTIONS	FOOT NOTE	GROUP/ TYPE NO.	O.E. CCA (@0°F)	YEAR	ENGINE/ OPTIONS	FOOT NOTE	GROUP/ TYPE NO.	O.E. CCA (@0°F)
<b>MASSEY-FERGUSON (Cont.)</b>					<b>MASSEY-FERGUSON (Cont.)</b>					<b>SMITHCO</b>				
<b>Tractors (Cont.)</b>					<b>Tractors - Mechanical Front Wheel Drive (Cont.)</b>					<b>Self Propelled Sprayers</b>				
MF 471 - 2/4WD, MF 481 - 2/4WD					MF 7619, MF 7620, MF 7622, MF 7624					SPRAY STAR 1002, SPRAY STAR 1008				
2004-02			27F	575	2014-12		2	48	730	2014-08			24F	575
MF 1225 - 2/4, MF 1230 - 2/4, MF 1233 - 2/4					MF 8220					SPRAY STAR 1010, SPRAY STAR 1602				
2005			24	585	2006-99		2	31T	800	2014-08			24F	575
MF 1235 - 4, MF 2315 - 2WD					MF 8240, MF 8250, MF 8260, MF 8270, MF 8280					SPRAY STAR 1604, SPRAY STAR 1610				
2005			24	585	2006-99		2	24	800	2014-08			24F	575
MF 1250 - 2/4, MF 1260 - 4					MF 8245					SPRAY STAR 1752, SPRAY STAR 1752D				
2005			24	675	2004-02		2	24	800	2014-08			24F	900
MF 1417 - 4, MF 1423 - 4, MF 1428 - 2/4					MF 8650, MF 8660, MF 8670, MF 8680, MF 8690					SPRAY STAR 1754, SPRAY STAR 3182				
2005			27	675	2014-12		2	49	730	2014-08			24F	900
MF 1429 - 4, MF 1433 - 4, MF 1433v - 4, MF 1440					<b>Tractors - Sub-Compact</b>					<b>STEIGER</b>				
2005			27	675	MF GC					<b>Tracked Ag Tractors</b>				
MF 1440v - 4					2007-06					350, 400, 450, 450 Quadtrac, 500, 500 Quadtrac				
2005			27	675	<b>Windrowers</b>					2012-11				
MF 3315 GE 4WD, MF 3315 S 4WD					MF 9225					2				
2005			49	750	2009-06			31T	950	550, 550 Quadtrac, 600, 600 Quadtrac				
MF 3315 V 4WD, MF 3330 GE 2/4WD					MF 9425					2012-11				
2005			49	750	2006		2	31T	950	2				
MF 3330 S 2/4WD, MF 3330 V 2/4WD					MF 9430					4DLT				
2005			49	750	2011-08		2	31T	950	1000				
MF 3340 F 2/4WD, MF 3340 GE 2/4WD					MF 9435					2012-11				
2005			49	750	2011-07		2	31T	950	2				
MF 3340 V 2/4WD, MF 3350 F 4WD					MF 9635					4DLT				
2005			49	750	2011-06		2	31T	950	1000				
MF 3350 GE 4WD, MF 3355 F 4WD					WF 9725, WF 9735, WF 9740, WF 9760, WF 9770					2012-11				
2005			49	750	2014-11		2	31T	950	2				
MF 3355 GE 4WD					<b>MELROE COMPANY</b>					2012-11				
2005			49	750	<b>Farm</b>					4DLT				
MF 4325, MF 4335, MF 4345, MF 4355, MF 4360					220					1000				
2005		2	34	710	1995	Gas		24	400	2012-11				
MF 4355 2/4, MF 4360 2/4, MF 4370 2/4					320, 322, 325, 328, 331, 337					2				
2004-02	34 or 78 Group	2	34	800	2000-95	Diesel		26	500	4DLT				
MF 4370					864					2010-07				
2005		2	34	710	2000-99			24	600	2				
MF 8780					963					4DLT				
2004-02		2	31T	800	1998-96			31T	950	2				
MF5400 Series, MF5400SA Series, MF6400 Series					3000					2011-07				
2007-06			24	800	1995	Diesel		24	575	4DLT				
MF7400 Series, MF8400 Series					3640					2011-07				
2007-06			24	800	2000-96			30H	475	2				
<b>Tractors - 2-Wheel Drive</b>					<b>NELSON MANUFACTURING COMPANY</b>					2011-07				
MF 6170, MF 6180					<b>Specialty Cultivating Equipment</b>					4DLT				
1999-95		2,14	48	660	TREE SQUIRREL PRUNING TOWER					2011-07				
MF 6255, MF 6260, MF 6265, MF 6270, MF 6280					2014-06					2				
2006-99		2,14	48	510	<b>OWATONNA MFG. CO.</b>					4DLT				
MF 6290					<b>Farm</b>					2011-07				
2006-99		2,14	48	510	SHAKERS					2				
MF 8220					1995					Magnum Monobeam				
2006-99		2	31T	800	PRUNE-RITE					65				
MF 8240, MF 8250, MF 8260, MF 8270					<b>Self Propelled Pruners</b>					850				
2014-99		2	24	800	PR120 PRUNING TOWER					2014-09				
MF 8245					2014-08					24				
2004-02		2	24	800	PR180 PRUNING TOWER					2014-09				
MF 8280					2014-08					24				
2014-99		2	24	600	PR240 PRUNING TOWER					2014-12				
<b>Tractors - Low Profile</b>					<b>Self Propelled Pruners</b>					26				
4300 Series Low Profile					PR300 PRUNING TOWER					2014-12				
2005		2	34	710	2014-08			24	550	26				
<b>Tractors - Mechanical Front Wheel Drive</b>					2014-08					24				
MF 6170, MF 6180, MF 8120					2014-08					24				
1999-95		2,14	48	660	2014-08					24				
MF 6255, MF 6260					2014-08					24				
2005-99		2,14	48	510	2014-08					24				
MF 6265, MF 6270, MF 6280, MF 6290					2014-08					24				
2006-99		2,14	48	510	2014-08					24				
<b>Tractors - Mechanical Front Wheel Drive</b>					<b>VERSATILE</b>					<b>Farm</b>				
MF 6170, MF 6180, MF 8120					744					1999-95				
1999-95		2,14	48	660	2014-12					4DLT				
MF 6255, MF 6260					2014-12					85				
2005-99		2,14	48	510	2014-12					85				
MF 6265, MF 6270, MF 6280, MF 6290					2014-12					26				
2006-99		2,14	48	510	2014-12					26				
<b>Tractors - Mechanical Front Wheel Drive</b>					<b>Self Propelled Sprayers</b>					2014-12				
MF 6170, MF 6180, MF 8120					SX275					2014-11				
1999-95		2,14	48	660	2014-11					2				
MF 6255, MF 6260					2014-11					31T				
2005-99		2,14	48	510	2014-11					950				
MF 6265, MF 6270, MF 6280, MF 6290					2014-11					950				
2006-99		2,14	48	510	2014-11					950				

# Farm Equipment

YEAR	ENGINE/ OPTIONS	FOOT NOTE	GROUP/ TYPE NO.	O.E. CCA (@0°F)
<b>VERSATILE (Cont.)</b>				
<b>Tractors - 4WD Articulated</b>				
<b>305 4WD, 340 4WD</b>				
2011-08		3	31T	950
<b>350 4WD, 450 4WD, 500 4WD, 550 4WD</b>				
2014-12		3	31T	950
<b>375 4WD, 400 4WD, HHT 435, HHT 485, HHT 535</b>				
2014-08		3	31T	950
<b>HHT 575</b>				
2014-10		3	31T	950
<b>Tractors - Mechanical Front Wheel Drive</b>				
<b>190, 220, 305</b>				
2014-10		3	31T	950
<b>250, 280</b>				
2014-08		3	31T	950
<b>YANMAR</b>				
<b>EX2900, EX3200</b>				
2014-11			24	540
<b>SC2400</b>				
2014-10			24	540

# Lawn & Garden / Small Engine

YEAR	MODEL	FOOT NOTE	GROUP/ TYPE NO.	O.E. CCA (@0°F)	YEAR	MODEL	FOOT NOTE	GROUP/ TYPE NO.	O.E. CCA (@0°F)	YEAR	MODEL	FOOT NOTE	GROUP/ TYPE NO.	O.E. CCA (@0°F)	
<b>AGCO ALLIS</b>					<b>ARIENS/GRAVELY (Cont.)</b>					<b>ARIENS/GRAVELY (Cont.)</b>					
<b>Garden Tractors</b>					<b>Commercial Riding Mowers (Cont.)</b>					<b>Rear Engine Riders (Cont.)</b>					
2014-06	1723H, 1723PS		U1	340		Pro Master 300 Series		U1			1330, 1332		B12A-A		
2014-06	2027H, 2027LC		51	500		Pro Master 30H		26R		2004-01	1440 Hydro		U1	235	
2005-98	918H		26R	390		Pro Master 400 Series		24F		2006	14532 Hydro		U1	235	
<b>Gear Lawn Tractors</b>						Pro Master 60		70			RER 10/28 Hydro		U1	235	
	1615G		U1	200		Pro Master ATM 72		26			RER 12/32 Hydro		U1	235	
	1640		U2	235		Professional 10		26R			RER 14/40 Hydro		U1	235	
	1716G, 409G		U1	200		Professional 10QS		26R		<b>Snowblower</b>					
	411G, 412G, 512G		U1	200		Professional 12G		26R			Sno-Thro ST-1336		U1		
	514G, 515G		U1	200		Professional 12QS		26R			Zoom 2050		U1	235	
	516VH		U1	200		Professional 12QS		26R			Zoom 2250		U1	235	
<b>Hydrostatic Garden Tractors</b>						Professional 16		26R		<b>Tillers</b>					
	1618H, 1716H		U1	340		Professional 16G		26R		1995	91400 Electric-start		B12A-A		
	1717H, 1718H		U1	340		Professional 18G		26R		<b>Zero-Turn Mowers</b>					
	1720H		U1	340		Professional 20G		26R		2004-03	1232, 1540		U1	235	
	1820H, 1820H PS		51	500		Professional 24G		26R		2009-03	1640, 2552		U1	235	
	1823H PS		51	500		Professional 8		26R		2009-05	1840, 2044		U1	235	
	1918H, 1920H		22F	390		<b>EZ Rider</b>					2005-03	1944, 2148, 2352		U1	235
	2020H, 2020LC		51	500		(Briggs), EZR 1440		U1	235	2009-05	2044XL, 2348		U1	235	
	2023H, 2024H		51	500		EZR 1640		U1	235	2009-05	2348XL		U1	235	
	2025H		51	500		<b>Garden Tractors</b>					1999-96	EZR 1540		U1	235
	918PS		26R	390		1340, 2200, 2548		U1	235	2003-99	EZR 1542		U1	235	
<b>Hydrostatic Lawn Tractors</b>						929000 Series		U1R		1999-96	EZR 1648		U1	235	
	1316H, 1614HV		U1	340		931000 Series		U1R	235	2003-99	EZR 1742		U1	235	
	1615H, 1615HC		U1	340		934000 Series		U1R	235	2003-99	EZR 1842		U1	235	
	1616H, 1617H		U1	340		935000 Series		U1R	235	2003-00	EZR 2048		U1	235	
	512H, 515H, 517H		U1	200		936000 Series		U1R	235	2003-00	EZR 2050		U1	235	
<b>Hydrostatic Riding Mowers</b>						GT-736E, GT-836		U1	235	2009-05	Mini Zoom 1534		U1	235	
	411G, 412H, 413H		U1	200		HT16, HT18		U1R	235		Sport Zoom 1232		U1	235	
<b>Lawn Tractors</b>						<b>Imperial Models (Rear Engine Riders)</b>						Sport Zoom 1440		U1	235
2005-00	1614VH		U1	340		RM 1328E		B14-A2			Zoom 1440		U1	235	
2014-06	1620HV		U1	340		RM 1330		B14-A2			Zoom 1640		U1	235	
2005-98	514H		U1	200		RM 1332E		B14-A2			Zoom 1844		U1	235	
2005-99	516H		U1	200		RM 8028, RM 828E		B14-A2			Zoom 2048		U1	235	
2014-06	520H, 522H, 524H		U1	200		RM 8530		B14-A2			Zoom 2252XL		U1	235	
<b>Rear Engine Riders</b>						<b>Lawn &amp; Yard Tractors</b>						Zoom 2252		U1	235
2003-97	414G		U1	200		901000 Series		B12A-A		<b>ATLAS TOOL &amp; MFG. CO.</b>					
2003-98	414H		U1	200		YT10, YT11		U1		<b>Lawn &amp; Garden Equipment</b>					
2003-01	416H		U1	200		YT12/32, YT12/38		U1R			ER2600, ER2650		12N9-3A		
<b>Zero-Turn Mowers</b>						YT14/38		U1R			ER2680		12N9-3A		
2000-98	ZT1438, ZT1644		U1	340		<b>Lawn Tractors</b>						ER3000		U1	
2000-98	ZT1850		U1	340		2005-01	1542		U1	235		ER3280		12N9-3A	
<b>Zero-Turn Radius Riders</b>						2000-98	1548H		U1	235	<b>BAD BOY</b>				
	ZT14H		U1	235		2000-97	1648H		U1	235	<b>5200 Series</b>				
	ZT1638		U1	340		2005-00	1742, 2048		U1	235	<b>6000 Series</b>				
	ZT16H, ZT18H		U1	235		2001-00	2248		U1	235	<b>720S Series</b>				
<b>AIR ELECTRIC MACHINE CO.</b>						<b>Mowers</b>						Junior 60		U1	300
<b>Lawn &amp; Garden Tractors</b>						2007	Zoom 1634		U1	235	<b>K27 Pro Series</b>				
	380, DS-25, DS-30		U1	235		2007	Zoom 1840		U1	235	<b>K29 Pro Series</b>				
<b>ALLIS-CHALMERS</b>						2007	Zoom 2350		U1	235	<b>Senior 72</b>				
<b>Lawn &amp; Garden Equipment</b>						2006	Zooms - Series		U1	235	<b>BEAR CAT</b>				
	405, 508		B9-B			<b>Other</b>					<b>Chipper/Shredders</b>				
<b>ARIENS/GRAVELY</b>						IHDE-130		U1	235		70554, 73525		U1	250	
<b>Commercial Riding Mowers</b>						IHSE-126		U1	235		74554, 74800		U1	250	
	1330, 1332, 8028		B14A-A2			IHSE-408		U1	235		74821, 75124		U1	250	
	8530		B14A-A2			RHE-126		U1	235		LL145		U1	250	
	912000 Series		B12A-A			RTH-132		U1	235	<b>Commercial Chippers</b>					
	914000 Series		U1	235		<b>Rear Engine - Sierra Models</b>					1999-96	71014, 71825		U1	250
	925000 Series		B12A-A			1340G, 1340H		U1	235	2014-96	71020, 72928		U1	250	
	927000 Series		B12A-A			1440G, 1440H		U1	235	2014-02	71620, 72620		U1	250	
	Commercial 10		26R			1450H, 1540H		U1	235	2001-96	72825		U1	250	
	Commercial 12		26R			1640H		U1	235	2001-99	73120, 73125		U1	250	
	Commercial 12G		26R			2001-96	Grand Sierra 2200 (GS22H)		U1R	235	2014-96	73413		U1	250
	Commercial 20G		26R			2001-96	High Sierra 1640H		U1	235	2014-99	73420		U1	250
	Commercial 5260		26R			2001-99	High Sierra 1848		U1	235	2001-99	74520		U1	250
	Commercial 5645		26R			2014-03	High Sierra 1848H		U1	235	2014-03	74624, 74628		U1	250
	Commercial 812		26R			<b>Rear Engine Riders</b>					2014-01	74824, 75524		U1	250
	Commercial 816S		26R			1028		B12A-A		2014-04	77412		U1	250	
	Commercial 818		26R			2006	10528 Hydro		U1	235	2011-04	77413		U1	250
	Commercial 818		U1R			2004	1232 Hydro		U1	235	<b>Shredders</b>				
	Comm-Rider 18		26R			2003-02	1232 Hydro/ST1336		U1	235	2014-95	70050		U1	250
	Convertible Super		26R				12900 Series		U1	235	2014-98	70080		U1	250
	Pro Master 18G		26R			<b>ATLAS TOOL &amp; MFG. CO.</b>					2014-01	70085, 70180		U1	250
	Pro Master 20G		26R			<b>Lawn &amp; Garden Equipment</b>									







# Lawn & Garden / Small Engine

YEAR	MODEL	FOOT NOTE	GROUP/ TYPE NO.	O.E. CCA (@0°F)	YEAR	MODEL	FOOT NOTE	GROUP/ TYPE NO.	O.E. CCA (@0°F)	YEAR	MODEL	FOOT NOTE	GROUP/ TYPE NO.	O.E. CCA (@0°F)
<b>FERRIS (Cont.)</b>					<b>GILSON (Cont.)</b>					<b>GRAVELY (Cont.)</b>				
<b>Riders (Cont.)</b>					<b>Yard Tractors</b>					<b>Lawn &amp; Garden Tractors</b>				
	Pro Driver 72		U1	245		12.5, 12E, 16, 16E 16EH, NA1500		U1 U1			GLT 440, GLT 448 GLT600		U1 U1R	
<b>Riding Rotary Turf Mowers</b>					<b>GOSSEN</b>					<b>Mowers</b>				
2014-04	Pro Cut 20		U1	245	<b>Bale Choppers</b>					2007-06	XDZ		U1	300
2003-98	Pro Cut 22		U1	245	NA6000, NA8500 SBC500P					2007	XL Series		U1	300
2003-98	Pro Cut 32		U1	245	SBC6000, G-350					2007	XLP Series		U1	300
<b>Zero-Turn Mowers</b>					<b>GRASSHOPPER</b>					<b>Out Front Mowers</b>				
2014-11	Evolution		U1	340	<b>Lawn &amp; Garden Tractors</b>					2007	Outfront		U1	300
2014-04	IS 1500Z, IS 2000Z		U1	245	1200, 1212, 1600					2007-06	PM 250		70	525
2014-09	IS 2500Z		U1	245	411, 600 Series						PM 310		U1	540
2014-04	IS 3100Z		U1	245	700 Series (Air cooled)						PM 320Z		U1	300
2014-10	IS 3100ZP		U1	245	700 Series (Liquid cooled)						PM 360, PM 468		24F	525
2011-04	IS 4500Z		58	245	800 Series (Air cooled)						Pro 12.5, Pro 15		U1R	
2014-04	IS 5100Z		26	245	800 Series (Liquid cooled)						Promaster Series 100		U1R	
2014-04	IS 5100Z		58	245	800 Series (Liquid cooled)						Promaster Series 200 ex. 260Z		U1R	
2014-12	IS 600Z, IS 700Z		U1	340	900 Series						Promaster Series 300		U1R	
2003-96	Pro Cut Z		U1	245	<b>Mowers</b>						Promaster Series 360		26R	440
2010-97	Ultra Belt GD		U1	245	2007 MidMount						Promaster Series 400		24F	525
<b>FLO-MOW MOWER COMPANY</b>					<b>Sit Down, Front Cut</b>					<b>Pro G Series Mowers</b>				
<b>Lawn &amp; Garden Equipment</b>					725					988100, 988101				
	Jetx 26		22NF		Zero-Turn Mowers					988103, 988104				
	Jetx 2668, 100, 120		U1		2009-04 120, 120K, 218					988105, 988106				
<b>FORD</b>					2004-99 220, 225					988107, 988108				
<b>Lawn &amp; Garden Tractors</b>					2009-04 223, 227, 233					988109				
	125, 145, 165, 66		U1		2009-04 322D					988110, 988112				
	70, 75, 80, LGT100		U1		2009-03 327					988113				
	LGT120, LGT125		U1		2009-03 428D					988114, 988115				
	LGT145, LGT165		U1		2009-04 432, 718KH2					<b>Riding Rotary Turf Mowers</b>				
	LT75, RMT66		U1		2003-95 614, 718, 721					2003-98 PM 300				
<b>GENERAL APPLIANCE</b>					2009-95 616					2003-98 PM 460				
<b>Lawn &amp; Garden Equipment</b>					2009-97 618					<b>Skidster</b>				
	All electric start		U1		2004-95 720, 725K					200				
<b>GENERAL POWER (TRU-TEST, WHEELER, LAWN CHIEF)</b>					2003-95 721D, 721D2					<b>Two Wheel Tractor Power Units</b>				
<b>Lawn &amp; Garden Tractors</b>					2009-04 721DH2, 722D2					Professional 10				
	3-725-E7, 3-725-E8		B12A-A		2009-04 723KH2, 727K2					Professional 12				
	3-725-E9, WES725		B12A-A		2009-04 729G2					Professional 16				
	WES725-FS		B12A-A		2009-04 928D2					Professional 18				
<b>GIANT-VAC</b>					2014-10 Front Mount 616T					Professional 8				
<b>Leaf Vacuums</b>					2014-10 Front Mount 620T					<b>Vacuums</b>				
2014-98	1001-CHW		U1	235	2014-10 Front Mount 721DT					ProVac 1050				
2014-99	1901-CEHW		B14L-A2		2014-10 Front Mount 723T					26R				
2014-99	2501-CEHW		U1	235	2014-10 Front Mount 725DT					<b>Walk-Behinds</b>				
<b>Mowers</b>					2014-10 Front Mount 727T					Pro 60				
	Giant Mow		B14L-A2		2014-10 Front Mount 729BT					B16L-B				
<b>Pro Series</b>					2014-10 Front Mount 729T					<b>Zero-Turn Mowers</b>				
	Pro Series		U1	235	2014-10 Front Mount 735BT					2009-04 144Z, 148Z, 152Z				
<b>Vacuums</b>					2014-10 Front Mount 930D					2009-04 160Z				
	1601-CEHW		B14L-A2		2014-04 Front Mount 932					2009-04 252Z, 260Z, 272Z				
	3001-CHW		U1	235	2014-10 Mid Mount 120K					2003-98 PM 250Z				
	6001-CHW		U1	235	2014-10 Mid Mount 124					2014-10 Pro-Ride 254				
<b>Walk Behinds</b>					2014-10 Mid Mount 220					2014-10 Pro-Ride 260				
	1601-CHW		U1	235	2014-10 Mid Mount 223					2014-10 Pro-Ride 266				
	1901-CHW		U1	235	2014-10 Mid Mount 227					2014-10 Pro-Turn 148				
	2501-CHW		U1	235	2014-97 Mid Mount 321D					2014-10 Pro-Turn 152				
	Turf Dominator		B14L-A2		2014-10 Mid Mount 325D					2014-10 Pro-Turn 160				
<b>GILSON</b>					2014-04 Mid Mount 329					2014-12 Pro-Turn 252				
<b>Garden Tractors</b>					2014-10 Mid Mount 329B					2014-10 Pro-Turn 260				
	14, 14E, 14HE		U1		2014-10 Mid Mount 335					2011-10 Pro-Turn 266				
	18E, 18HE, All		U1		2014-10 Mid Mount 403D					2014-12 Pro-Turn 272				
<b>Turf Vehicles</b>					2014-10 Mid Mount 432					2014-12 Pro-Turn 452				
	53018, 53019		26R		<b>GRAVELY</b>					2014-12 Pro-Turn 460				
	53021, 53023		26R		<b>Chipper/Shredders</b>					2014-12 Pro-Turn 460				
	53024, 53025		26R		ProChip 210					2014-12 Pro-Turn 472				
	53026, 53027		26R		ProChip 310					2014-12 Pro-Turn 472				
	53028		26R		ProChip 395					2014-12 Pro-Turn 472				
	53037, 11E, 11EH		U1		<b>Commercial Walk-Behind Mowers</b>					2014-10 ZT 34, ZT 42				
					2011-04 320HD					2014-10 ZT 50				
					1999-95 Pro 14					<b>Zero-Turn Radius Mowers</b>				
					2003-97 Pro 150 Series					ZT1740, ZT1842				
										ZT2048, ZT2050				
										ZT2148, ZT2352				

# Lawn & Garden / Small Engine

YEAR	MODEL	FOOT NOTE	GROUP/ TYPE NO.	O.E. CCA (@0°F)	YEAR	MODEL	FOOT NOTE	GROUP/ TYPE NO.	O.E. CCA (@0°F)	YEAR	MODEL	FOOT NOTE	GROUP/ TYPE NO.	O.E. CCA (@0°F)
<b>GREAT DANE</b>					<b>HOWARD PRICE TURF EQUIPMENT</b>					<b>HUSQVARNA (Cont.)</b>				
<b>Commercial Walk-Behind Mowers</b>					<b>Commercial Walk-Behind Mowers</b>					<b>Tractors (Cont.)</b>				
2010-05	Scamper 48		U1	265	2005-99	WB36-14K		U1	190		GTH2548XP		U1R	
2010-05	Scamper 52		U1	265	2005-99	WB36H-14K		U1	190		LR110, LR120		U1R	
2010-05	Scamper HG 36		U1	265	2005-99	WB48-14K		U1	190		LR122, LR125		U1R	
2010-05	Scamper HG 48		U1	265	2005-99	WB48H-14K		U1	190		LRH125, LT 120		U1R	
2010-05	Scamper Hydro		U1	265	2005-99	WB52-14K		U1	190		LT 130, LT 18542		U1R	
<b>Sit Downs</b>					<b>Rider, All</b>									
	Chariot XL 48		U1	265	2005-00	WB52-17K		U1	190		LTH 1742		U1R	
<b>Walk-Behinds</b>					<b>Riding Rotary Turf Mowers</b>									
	Champ		U1	265	2005-99	Hydra Power 1280		24	440		LTH120		U1	
	Chariot Jr Line		U1	265	2006-95	Hydra Power 1280		27	440		LTH120		U1R	
	GD 51KH		U1	265	2006-95	Hydra Power 180	2	24	500		LTH130		U1	
	GDZ 52KH		U1	265	2006-95	Turf Blazer 530		24	500		LTH130		U1R	
<b>Zero-Turn Mowers</b>					<b>Turf Blazer</b>									
2010-05	Brutus		U1	265		Turf Blazer 48		U1			LTH130		U1R	
2005-00	Chariot		U1	265		Turf Blazer 52		U1			LTH140		U1	
2008-05	Chariot 48		U1	265		<b>Utility Vehicles</b>						U1R		
2008-05	Chariot 52		U1	265		<b>Maverick 620</b>						U1		
2008-05	Chariot 61		U1	265		<b>Zero-Turn Mowers</b>						U1R		
2005-00	Chariot Jr.		U1	340		<b>Radius Riders</b>						U1		
2008-05	Chariot XL 61		U1	265		<b>Turf Blazer 360Z</b>						U1	190	
2008-05	Chariot XL 72		U1	265		<b>HUFFMAN (HUFFY)</b>								
2005-03	Gateway 52		U1	340		<b>Riding Mowers</b>								
2005-00	Scamper		U1	265		<b>32 Riders</b>						U1		
2008-05	Super Surfer 48		U1	265		<b>H-270, H-360</b>						B12A-A		
2008-05	Super Surfer 52		U1	265		<b>HULL INDUSTRIES</b>								
2008-05	Super Surfer 61		U1	265		<b>Lawn &amp; Garden Equipment</b>								
2008-06	Surfer		U1	265		<b>TC30 ER</b>						B16-B		
<b>HAHN</b>					<b>HUSQVARNA</b>					<b>Zero-Turn Mowers</b>				
<b>Lawn &amp; Garden Tractors</b>					<b>Garden Tractors</b>									
	126, 130, 132, 736		U1		2005-00	22550 XP		U1R		2009-04	BZ6127TD		51	460
	836, 11/76, 11/77		U1		2005-00	GTH2248XP		U1R	190	2009-04	BZ7234TD		51	460
<b>HEILMAN ENTERPRISES</b>					<b>HUSQVARNA</b>					<b>Zero-Turn Mowers</b>				
<b>Lawn &amp; Garden Equipment</b>					<b>Garden Tractors</b>									
	11/78		U1		2005-00	GTH2250XP		U1R	190	2009-04	IZ4217T, IZ4817T		U1	190
	220, 440, 445, 550		U1R		2005-00	GTH2350		U1R		2009-04	IZ4218, IZ4818		U1	
	555		U1R		2005-00	GTH2548XP		U1R		2009-06	IZ4819T		U1	190
	8/76, 8/77		U1		2005-00	GTH2550XP		U1R	190	2009-04	IZ4821T, IZ5221T		U1	190
<b>HESSTON CORPORATION</b>					<b>HUSQVARNA</b>					<b>Zero-Turn Mowers</b>				
<b>H-160, H-200</b>					<b>Garden Tractors</b>									
			22NF		2005-00	GTH2550XP		U1R	190	2009-06	IZ5223T		U1	190
<b>HOMELITE/JACOBSEN</b>					<b>HUSQVARNA</b>					<b>Zero-Turn Mowers</b>				
<b>Lawn &amp; Garden Tractors</b>					<b>Garden Tractors</b>									
	180HIE63		U1	255	2005-00	GTH2548XP		U1R		2009-06	IZ6123T		U1	190
	730-OLE		U1R		2005-00	GTH2550XP		U1R	190	2009-06	IZ6125T		U1	190
	CT-10		22NF	350	2000-99	GVTHT205, YTH145		U1R	245	2003-99	ZTH4218		U1	340
	LT-1034, LT-1242		U1R		2011-06	LGT2654		U1R	280	2003-99	ZTH4218QL		U1	340
1998	LT1238G		U1	255	2000-99	YTH150, YTH180		U1R	245	2003-99	ZTH4221QL		U1	340
	LT1438G		U1	255	2014-00	YTH1542XP		U1R	245	2003-99	ZTH4818		U1	340
	RE1030E		B9-B			YTH1746		U1R		2003-99	ZTH4820		U1	340
	RE1230E, RE830E		B9-B		2005-00	YTH1848XP		U1R	340	2003-99	ZTH4821		U1	340
	RE-8E		B9-B			YTH2046		U1R		2003-99	ZTH5221		U1	340
	T-10, T-135, T-16		22NF	350		YTH2048		U1R		2003-00	ZTH5223		U1	340
	T-8, YT-14, YT-16		U1R		2014-06	YTH2146XP		U1R	190	2003-00	ZTH5223L		U1	340
	YT-18		U1R			YTH2148		U1R		2003-00	ZTH5223XL		U1	340
<b>HONDA</b>					<b>HUSQVARNA</b>					<b>Zero-Turn Radius Rider Mowers</b>				
	H2113HDA		U1		2014-06	YTH2242		U1R	230	2003-01	ZTH6126		U1	340
	H2113SDA, H3009		U1		2014-06	YTH2348		U1R	230		BZ6134D		51	
	H3810, H3813		U1	340		YTH2454		U1R	190		CZ4815, CZ4817		U1	
	H4013, H4118HDA		U1		<b>Lawn &amp; Garden Equipment</b>						U1			
	H4120, H4120HDA		U1			1200-18H		U1R			ZTH 226EFI		U1	
	H4213, H4418		U1			970 Rider Series		U1R			ZTH1625XP		U1	
	H4514, H4518		U1			970-125, 970-155		U1R			ZTH6123LXP		U1	
<b>Riding Mowers</b>					<b>Lawn Tractors</b>									
	H1011HDA		U1	165		970-15B,		U1R			ZTH6123LXPQL		U1	
	H1011SDA		U1	165		970H-155		U1R			ZTH6127SPQL		U1	
	Harmony 1011		U1	170		Pro 15, Proflex 21		U1R			ZTH6215SPQL		U1	
	Harmony 2013		U1	170		Rider 16H		U1R			ZTH7226XP		U1	
<b>Walk Behinds</b>					<b>Lawn Tractors</b>									
	HRC 7000 Series		U1		2014-06	2042LS, 2246LS		U1R	230		ZTH7226XPQL		U1	
	HRC 7018		U1		2014-06	2346XLS, 2348LS		U1R	230		ZTH7227XPQL		U1	
	HRC 7020		U1		2014-06	2748GLS		U1R	230				U1	
					2014-06	2754GLS		U1R	230				U1	
					2014-06	LTH1538		U1R	230				U1	
					<b>Tractors</b>									
						CTH130, CTH150		U1R					U1	
						GT200, GTH220		U1R					U1	



# Lawn & Garden / Small Engine

YEAR	MODEL	FOOT NOTE	GROUP/TYPE NO.	O.E. CCA (@0°F)	YEAR	MODEL	FOOT NOTE	GROUP/TYPE NO.	O.E. CCA (@0°F)	YEAR	MODEL	FOOT NOTE	GROUP/TYPE NO.	O.E. CCA (@0°F)
<b>JOHN DEERE (Cont.)</b>					<b>JOHN DEERE (Cont.)</b>					<b>KUBOTA (Cont.)</b>				
<b>Lawn Tractors (Cont.)</b>					<b>Zero-Turn Mowers (Cont.)</b>					<b>F-Series</b>				
2005-03	SST15		U1	255	2012-10	Z-Trak Pro Z950A		U1	340	F2100, F2400			25	450
2005-00	SST16, SST18		U1	255	2012-10	Z-Trak Pro Z960A		U1	340	<b>Garden Tractors</b>				
1997-95	STX38, STX46		U1	300	2012-10	Z-Trak Pro Z970A		U1	340	2006-04	BX1500		26R	450
<b>Rear Engine Riders</b>					2012-10	Z-Trak Z710A		U1	300	2003	BX1500		26	450
1996-95	GX75, SRX75		U1	300	2011	Z-Trak Z720A		U1	340	2006-99	BX1800		26	450
2004-97	GX85		U1	300	2011	Z-Trak Z915B		U1	340	2006-99	BX1800		26R	450
1996-95	SRX95		U1	300	2011	Z-Trak Z920M		U1	340	2014-07	BX1850		26	450
2003-97	SX85		U1	300	2011	Z-Trak Z920R		U1	340	2014-07	BX1850		26R	450
<b>Riding Bunker and Field Groomers</b>					2011	Z-Trak Z925M		U1	340	2006-99	BX2200		26	450
2014-95	1200A		U1	300	2011	Z-Trak Z930M		U1	340	2006-99	BX2200		26R	450
<b>Riding Mowers</b>					2011	Z-Trak Z930R		U1	340	2014-07	BX2350		26	450
2004	G345		45	500	2011	Z-Trak Z950R		U1	340	2014-07	BX2350		26R	450
	GX Heavy Duty		U1	345	2011	Z-Trak Z960R		U1	340	2014-95	G1800, G1900		51R	450
	GX70, GX95, R72		U1	300	2011	Z-Trak Z970R		U1	340	2014-01	G2160, G2160-R48		51R	450
	R92, RX75, RX95		U1	300	<b>JONSERED</b>					2006-01	G2460G		51R	450
<b>Riding Reel Mowers</b>					<b>Lawn &amp; Garden Equipment</b>					2012-07	GF2010, GF2110		U1	285
1998-95	2243		45	500	LT15			U1R		2007-04	GR2000, GR2100		U1	285
1998-95	2243		22F	490	LT15 Automatic			U1R		<b>G-Series Tractors</b>				
1998-95	2243		U1	342	<b>KAWASAKI</b>					G2160D-R485		51R	450	
2003-99	2500 Tri-Plex		51	500	<b>Mule</b>					G2460		51R	450	
2014-04	2500A, 2500E		51	500	2000 Series		U1	300	<b>Lawn Tractors</b>					
2003-95	2653		45	500	2500 Series		U1	300	2004-95	T1460, T1560		U1	285	
2003-95	2653		U1	340	3000 Series		U1	300	2007-05	T1570, T1670		U1	285	
2003-95	2653A		45	500	500 Series		U1	300	2004-96	T1760		U1	285	
2003-95	2653A		U1	340	550 Series		U1	300	2007-05	T1770, T1870		U1	285	
2014-04	2653A Professional		45	500	<b>Utility Hauling Vehicles</b>					2014-07	T1880, T2080		U1	285
2014-04	2653A Professional		U1	340	Mule 550			B14-A2		2014-07	T2380		U1	285
2003-95	3215B		45	500	<b>KEES</b>					2005-99	TG1860 Diesel		51R	450
2003-95	3215B		51	500	<b>Lawn &amp; Garden Equipment</b>					2005-00	TG1860 Gas		51R	450
2014-04	3225C, 3235C		51	500	48, 60			U1		<b>L-Series Tractors</b>				
2003-95	3235B		45	500	ZT Max Rider			U1		L185		24F	550	
2003-95	3235B		51	500	<b>KIOTI</b>					L185 Opt.		30H	550	
2006-04	3245C (Rotary Deck)		51	500	<b>Compact Tractors</b>					L235		24F	550	
<b>Riding Rotary Turf Mowers</b>					<b>B-Series Tractors</b>					L235 Opt.		30H	550	
2014-05	1420, 1435, 1445		45	480	B1700, B2100			51R	405	L2350		24F	490	
2014-05	1545, 1565		45	480	B2150			24F	415	L245		24F	550	
2014-99	1600 Turbo Wide Area		27	650	B2400, B2410			51R	405	L245 Opt.		30H	550	
2003-99	1620		27	650	B2710, B2910			51R	450	L2500		24F	490	
2003-97	F1145		45	500	B5100			U1		L260		24F	550	
2002-95	F510, F525		U1	342	B6100			24F	550	L260 Opt.		30H	550	
2004-97	F725		22F	491	B7100			U1		L2600DT, L2600F		24	585	
2003-98	F735		45	500	B7300			51	450	L2650		24F	490	
2003-97	F911, F925, F932		26	490	B7400			51R	450	L275		24F	550	
2003-97	F935		26	490	B7400, B7400HSD			51R	450	L275 Opt.		30H	550	
<b>Skid Steer Loaders</b>					<b>KUBOTA</b>					L2800		24	585	
	120, 125, 170		24		<b>B-Series Tractors</b>					L285		24F	550	
	375		70		B1700, B2100			51R	405	L285 Opt.		30H	550	
	60		U1		B2150			24F	415	L2900		24	585	
	756, 90		24		B2400, B2410			51R	405	L295		24F	550	
<b>Walk Behind Mowers</b>					<b>BX-Series Sub-Compact Tractors</b>					L295 Opt.		30H	550	
	32, 36, 48, 52		U1		B2710, B2910			51R	450	L2950		24F	490	
<b>Waste Handler</b>					<b>Compact Tractors</b>					L3000		24	585	
2004	4 WHL DR - 624 J	2	30H	625	B5100			U1		L3000DT		24	585	
<b>Zero-Turn Mowers</b>					<b>B-Series Tractors</b>					L3000F		24	585	
2004	647		U1	340	B6100			24F	550	L3010		24	490	
2012-05	647A Quik Trak		U1	340	B7100			U1		L305		24F	550	
2003	657, 667, 737, 757		U1	340	B7300			51	450	L305 Opt.		30H	550	
2012-05	657A Quik Trak		U1	340	B7400			51	450	L3130, L3300		24	585	
2012-05	667A Quik Trak		U1	340	B7400, B7400HSD			51R	450	L3410		24F	490	
2009-04	717A Mini Z-Trak		U1	340	B7500			51	450	L3430		24	585	
2009-03	727A Mini Z-Trak		U1	340	B7500DHS			51R	450	L345		24F	550	
2009-04	737 Mid Z-Trak		U1	340	B7500DHS			51R	450	L345 Opt.		30H	550	
2009-04	757 Mid Z-Trak		U1	340	B7500DT			51R	450	L35		24	490	
2009-04	777 Max Z-Trak		U1	340	B7800			51	450	L355SS		24F	550	
2003	777, 797		U1	340	B7800			51R	450	L355SS Opt.		30H	550	
2009-04	797 Max Z-Trak		U1	340	B8200, B9200			24F	585	L3600		27	450	
2003-95	F680, M653		45	500	<b>BX-Series Sub-Compact Tractors</b>					L3710		24	585	
2009-04	F687 Front Z-Trak		U1	340	BX22			26R	450	L4000, L4200		27	450	
2003-96	M655		45	500	<b>Compact Tractors</b>					L4300, L4310		24	585	
2003-96	M665		26	490	1550, 1750			24	585	L4330, L4610GST		24	585	
2012-10	Z-Trak Pro Z910A		U1	340	1800, 1900, 2000			51	585	L4610HST, L4630		24	585	
2012-10	Z-Trak Pro Z920A		U1	340	2150, 4200, 5200			24	585	L5030		24	585	
2012-10	Z-Trak Pro Z925A		U1	340	6200			24	585	LA271		51R	450	
2012-10	Z-Trak Pro Z930A		U1	340	7200			24	585	LL2500		24	585	
					HST Series			24	585	<b>Riding Rotary Turf Mowers</b>				
					PX2100			U1		2014-95	F2260, F2560		26	450
										2014-95	F3060		26	450

# Lawn & Garden / Small Engine

YEAR	MODEL	FOOT NOTE	GROUP/ TYPE NO.	O.E. CCA (@0°F)	YEAR	MODEL	FOOT NOTE	GROUP/ TYPE NO.	O.E. CCA (@0°F)	YEAR	MODEL	FOOT NOTE	GROUP/ TYPE NO.	O.E. CCA (@0°F)
<b>KUBOTA (Cont.)</b>					<b>LAWN BOY (GILSON) / TORO (Cont.)</b>					<b>MASSEY-FERGUSON (Cont.)</b>				
Riding Rotary Turf Mowers (Cont.)					Other (Cont.)					Lawn & Garden Tractors (Cont.)				
2014-95	GF1800		51R	450						1244		24	200	
2003-96	GF1800E		51R	450	9369ES					1450, 1650, 1655		26R	390	
Tractors					Rear Engine Riders					1855, 85				
	M110, M120		4DLT	770	52145 (12 Hp)					Lawn Tractors				
	M4000, M4050		30H	525	RE 12e, RE 8e					2014-06 2518H, 2520H				
	M4500		30H	525	Yard Tractors					2014-06 2522H, 2524H				
	M4700, M5400		31A	700	YT16					2014-06 2620H				
	M6800		31A	700	<b>LAWN GENERAL (MURRY)</b>					Rear Engine Riders				
	M6800		31T	700	Lawn Tractors					2005-97 2411G				
	M8030, M8200		31A	700	12.5Hp/38					2005-98 2414H				
	M9000		31A	700	17.5Hp/46					Zero-Turn Riding Mowers				
	M9580		29H	660	20.0Hp/52					ZT 14H, ZT 16H				
	T1400, T1700HX		U1	285	<b>LESCO</b>					ZT 18H				
	T1700X, T1860		U1	285	Hydro Commercial Walk-Behinds					ZT 18H, ZT16				
	TG1850		51R	450	024952, 026348					ZT1850				
Turf Mowers					030248, 030252					<b>MAXIM</b>				
	ZD28		26R	450	701079, 701080					Handy-Haul Carts				
Utility Hauling Vehicles					Zero-Turn Mowers					MH85BE4T				
	Mule 2500		B16L-B		52ZTR					Rear Engine Riders				
	RTV900 4x4 Diesel		26DT		LCR 200 Tractor					BEICHP, M 830				
Utility Tractors					2004-99 Viper					M 830 B				
	B21, L35		51	450	<b>LOCKE-DEVERE</b>					M1230 BEIC				
Zero-Turn Mowers					Lawn & Garden Equipment					M30 BEIC				
2014-95	FZ2100, FZ2400		26	450	10, 12, 21, 22, 23					M830 BEIC				
2003-01	ZD18		26R	450	3, 5, 6, 8, 8/23					MH1230 BEIC ( 8, 12, 13, 14 Hp)				
2003-01	ZD18		51R	450	<b>MAGNUM</b>					Zero-Turn Mowers				
2009-04	ZD18F		26R	450	All					2002-97 Z3014, Z4214				
2009-04	ZD18F		51R	450	<b>MASSEY-FERGUSON</b>					2002-98 Z4216, Z4816				
2003-01	ZD21		26R	450	Compact Tractors					2002-97 Z4220				
2003-01	ZD21		51R	450	MF-10, MF-12					2003-99 Z4820				
2009-04	ZD21F		26R	450	MF14, MF16					Zero-Turn Radius Riders				
2009-04	ZD21F		51R	450	MF-7, MF-8					Z4316 BVG				
2009-04	ZD25F		26R	450	Garden Tractors					<b>MINNEAPOLIS-MOLINE</b>				
2009-04	ZD25F		51R	450	2014-06 2723H					Lawn & Garden Equipment				
2009-04	ZD28F		26R	450	2014-06 2723H, 2825H					All				
2009-04	ZD28F		51R	450	2014-06 2875H					<b>MITSUBISHI</b>				
2014-10	ZD321		51R	450	2014-06 2927H, 2927LC					Lawn & Garden Tractors				
2014-10	ZD323, ZD326		51R	475	Gear Lawn Tractors					160, 180				
2014-10	ZD331		51R	475	2409G, 2512G					210, 250				
2009-04	ZG20, ZG23		U1	285	2514G					<b>MONTGOMERY WARD</b>				
2014-09	ZG222, ZG227		U1	285	Hydrostatic Front					Garden Tractors				
2014-10	ZG327		U1	300	Cut 2316H					33000 Series				
2014-12	ZG332, ZP330		51R	475	Hydrostatic Garden Tractors					Riding Mowers				
<b>LASTEC</b>					2618H					1300-1400 Series				
Golf Course Mowers					2618H					99 and under Series				
	321D, 420D		26	525	2716H, 2717H					Series				
	425MD, 2861 FG		26	525	2718H					<b>MORIDGE MFG. INC.</b>				
Lawn & Garden Equipment					2720H					Lawn & Garden Equipment				
	2961 FG		26	525	2818H, 2818PS					1210, 1622, 1822				
	3385 WTD		26	525	2820H, 2820HPS					<b>MOWETT SALES CO.</b>				
	3696 WTD		26	525	2823HPS					Riding Mowers: Electric				
	Articulator 3377T		U1		2918H, 2920H					248E (All Electric)				
Zero-Turn Mowers					2920LC, 2923H					Riding Mowers: Gas				
2014-01	3682, 3696		26R	525	2924D, 2925H					1995 Mustang				
2003-97	421D, 425HD		26	525	Hydrostatic Lawn Tractors					<b>MTD</b>				
2014-11	4520		26	525	2512H, 2514H					Riders & Tractors				
<b>LAWN BOY (GILSON) / TORO</b>					2515G, 2515H					B560B, E451F				
Lawn & Garden Tractors					2516H, 2614H					G695G				
	333, 335		12N9-3A	350	2615H, 2615HC					H661F, L450C				
	53084 (18 Hp)		22F		2616C, 2616H					L660F				
	5802, 5803, 7258E		12N9-3A		2717H, 2316H					M660G, Q665H				
	7259E, 7260E		12N9-3A		Hydrostatic Riding Mowers					S825H				
	8227E, 8228E		12N9-3A		2412H, 2413H					Walk-Behinds				
	8229E, 8229EA		12N9-3A		Lawn & Garden					1848F, Z2256				
	8233E		12N9-3A		2007-06 MFZT29, MFZT33					Zero-Turn Mowers				
	ES Series		U1R	175	Lawn & Garden Tractors					Z2554				
	GT18, GT18H		26R	350	1200									
	LT11, LT12, LT12H		U1		1205, 1225									
Other					1231, 1232, 1235									
	9328E, 9328ES		U1		26R					390				
	9329E		U1R		51					500				
	9329ES		U1		24					200				
	9365ES, 9368E		U1											
	9368ES, 9369ES		U1											



# Lawn & Garden / Small Engine

YEAR	MODEL	FOOT NOTE	GROUP/ TYPE NO.	O.E. CCA (@0°F)	YEAR	MODEL	FOOT NOTE	GROUP/ TYPE NO.	O.E. CCA (@0°F)	YEAR	MODEL	FOOT NOTE	GROUP/ TYPE NO.	O.E. CCA (@0°F)
<b>RICH MFG. (Cont.)</b>					<b>SCAG (Cont.)</b>					<b>SEARS (Cont.)</b>				
<b>Lawn Equipment (Cont.)</b>					<b>Lawn &amp; Garden Tractors</b>					<b>Lawn &amp; Garden Tractors (Cont.)</b>				
2007-06	LP Series Chassis Models		U1	260		All STG-Series All ST-Series		U1 U1	220 220		502.256141 - 502.256142		B20L-BS	
2007-06	LP Series Deck Models		U1	260		<b>Lawn Equipment</b>					502.2561575 502.2561576		U1R U1R	
<b>Zero-Turn Walk-Behind Riders</b>					2004	STHM 61		U1	220		502.25617 - 502.25619		U1R	
2004-03	1700KL, 1700L		U1	260	2004	STHM 72		U1	220		536.250820 - 536.250823		12N9-3A	
2004-03	2000L, 2200L		U1	260	<b>Riding Rotary Turf Mowers</b>									
2004-03	2500L		U1	260	2014-98	STHM		U1	220		536.250920 536.250922 - 536.250922		12N9-3A	
	WR-1700		U1	260	<b>Zero-Turn Mowers</b>									
	WR-2000		U1	260	2014-07	FREEDOM Z		U1	220		536.255110 536.255112 - 536.255113		12N9-3A	
	WR-2200		U1	260	2004	Sabre Tooth Turf Tiger		U1	220		536.255212 - 536.255220		12N9-3A	
	WR-2500		U1	260	2008-05	SabreTooth Turf Tiger		U1	220		536.255221 - 536.255230		12N9-3A	
<b>ROOF MFG. CO.</b>					2014-09	Tiger Cat		U1	220		536.255232 - 536.255240		12N9-3A	
<b>Lawn &amp; Garden Equipment</b>					2008-06	Tiger Cub		U1	220		536.255250 536.657020 536.657040 - 536.657060		12N9-3A	
	30-N7-3, 30-N8-E		U1R		2004	Tiger Cub		U1	220		536.657080 - 536.658080		12N9-3A	
	492683, 493071		U1		2004	Tiger Cub		U1	220		536.963100 - 8-2525, 8-3035		12N9-3A	
	493081		U1		2014-04	Turf Tiger		U1	220		881400, 88170		B14L-A2	
	830-E		U1R		2012-03	Wild Cat		U1	220		917.25424 917.25431		U1R	
	NE-8, NR-8		26R		2008-04	Z Cat		U1	220		917.25435 917.25474		U1R	
<b>ROPER</b>					<b>SCOTT'S (BY MURRAY)</b>									
<b>Riding Mowers</b>					<b>Garden Tractors</b>									
	22, 322, 323, 622		U1			42531X8, 42561X8		U1	250		917.255121 - 917.259180		12N9-3A	
	63, 632, 633, 822		U1			46561X8, 46562X8		U1	250		917.255260 - 917.255270		B14L-A2	
	863		U1			50560X8, 50563XS		U1	250		917.255273 - 917.255330		B14L-A2	
	96444, 96927		B9-B		2003-00	S2048, S2348		U1	230		917.255340 917.25541		U1R	
	96941, K522, K832		B9-B			S2546		U1	230		917.25558		U1R	
	K852		B9-B		2002-98	S2554		U1	230		917.25582		U1R	
	K9224AR		B14L-A2		<b>Lawn Tractors</b>									
	K922PRA		B14L-A2		2002-00	S1642		U1	230		917.259320 917.259740 - 917.255120		12N9-3A	
	K9324AAR		B14L-A2		2001-00	S1742		U1	230		Compact, Custom		U1	
	K932PRA		B14L-A2		2003-00	S2046		U1	230		K8327AR		B9-B	
	L722, L72256R		B9-B		<b>SEARS</b>									
	L8000AT		B14L-A2		<b>Lawn &amp; Garden Tractors</b>									
<b>SABRE (BY JOHN DEERE)</b>														
<b>Garden Tractors</b>														
2002-98	1948GV, 1948HV		U1	230		131.96927 - 131.969310		12N9-3A			917.25541 917.25558		U1R	
2002-99	2148HV		U1	230		131.96941 - 131.96970		12N9-3A			917.25582		U1R	
2000	2254HV		U1	230		136, 137, 140, 141		B16L-B			917.259320		U1R	
2003-00	2354HV, 2554HV		U1	230		142		B16L-B			917.250740 - 917.255120		12N9-3A	
<b>Lawn &amp; Garden Tractors</b>														
	1538GS, 1538HS		U1	230		25424, 25431		U1			SS, ST, Suburban		U1	
	1542GS, 1642GS		U1	230		25432, 25434		U1					B9-B	
	1642HS, 1642HV		U1	230		25435, 25474		U1					U1	
	1646HS, 1646HV		U1	230		255113, 255120		B9-B					B9-B	
	1842GV, 1842HV		U1	230		255212, 255221		B9-B					B9-B	
	1843HV, 1848GV		U1	230		255223, 255232		B9-B					U1	
	1848HV, 2048HV		U1	230		255240, 255250		B9-B					U1	
	22354HV		U1	230		25541, 25558		U1					U1	
<b>Lawn Tractors</b>														
2002-99	1438GS, 1438HS		U1	230		25582, 256128		U1					U1	
2002-97	1542HS		U1	230		256135, 256321		U1					U1	
2001-99	1742GS, 1742HS		U1	230		256575, 256576		U1					U1	
2003-99	2046HV		U1	230		256619, 25700		U1					U1	
<b>SAKAI AMERICAN</b>														
<b>Lawn Equipment</b>														
	SW300, SW320		24	575		25710, 25760		U1					U1R	
	SW330		24	575		25770, 25780		U1					U1R	
<b>Rollers</b>														
2007-06	SW Series		24	575		502.23365 - 502.23366		B14L-A2					B14L-A2	
2004	SW300, SW320		24	575		502.256050 - 502.256051		B14L-A2					B14L-A2	
2004	SW330		24	575		502.256060 - 502.256063		B14L-A2					B14L-A2	
<b>SALACO</b>														
<b>Woodchippers</b>														
	84 Series		U1			502.256070 - 502.256071		B14L-A2					B14L-A2	
	86 Series		24F	575		502.256080 - 502.256081		B14L-A2					B14L-A2	
<b>SCAG</b>														
<b>Commercial Walk-Behind Mowers</b>														
2014-95	SW		U1	220		502.2561128		B14L-A2					B14L-A2	
2002-97	SWU		U1	220		502.256120 - 502.256126		B14L-A2					B14L-A2	
2014-96	SWZ		U1	220		502.256130 - 502.256132		B14L-A2					B14L-A2	
2011-97	SWZU		U1	220		502.2561321		U1R					B14L-A2	
						502.256134 - 502.256136A		B14L-A2					B14L-A2	
						502.256135 - 502.256136		B20L-BS					B20L-BS	
						502.256137 - 502.256140		B20L-BS					B20L-BS	
						502.256138		B14L-A2					B14L-A2	

# Lawn & Garden / Small Engine

YEAR	MODEL	FOOT NOTE	GROUP/ TYPE NO.	O.E. CCA (@0°F)	YEAR	MODEL	FOOT NOTE	GROUP/ TYPE NO.	O.E. CCA (@0°F)	YEAR	MODEL	FOOT NOTE	GROUP/ TYPE NO.	O.E. CCA (@0°F)	
<b>SIMPLICITY (Cont.)</b>					<b>SNAPPER (Cont.)</b>					<b>SPEEDEX (Cont.)</b>					
Lawn & Garden Equipment					Lawn & Garden Tractors (Cont.)					Lawn & Garden Tractors (Cont.)					
	Conquest 1700		U1	340		KZS18482, LT11		U1			820, 840, S17, S18		U1		
	Conquest 2700		U1	340		LT12, LT12D, LT16		U1			S19, S24		U1		
Lawn & Garden Tractors					Lawn Mowers					<b>SPIRIT</b>					
	12FCH, 16CFC		U1		2005	YZ15384BUE	57	U1	190	Hydrostatic Drive Riders					
	16FCC, 16GTH		U1		2005	YZ16424BUE	57	U1	190	1650H, 1850H					
	17GTH, 18CFC		26R		2005	YZ20484BUE	57	U1	190	1860H, 1136Q					
	3008, 3008-3		B9-B		2004-02	ZT18440KH		U1	340	Riding Mowers Q-Drive Riders					
	3105, 3108, 3110		U1		2004-02	ZT20500BU		U1	340	1236Q, 1442Q					
	4080, 4111, 4208		U1		Lawn Tractors					1650Q					
	4211, 4212, 5008		U1			LT 200H48		U1	220	Zero-Turning Radius, Rear Engine					
	5010		22NF		2005-00	LT145H33GBV		U1	220	Lawn Pro 14H					
	5211, 5212, 5216		U1		2005-98	LT145H38GBV		U1	220	Lawn Pro 16H					
	6008, 6011, 6211		U1		2001-00	LT150H38GKV		U1	220	Lawn Pro 18H					
	6216		U1		2005-98	LT160H42GBV		U1	220	Lawn Pro 20H					
	7010, 7012, 7013		22NF		2005-96	LT180H48GBV2		U1	220	Lawn Sport 14LS					
	7014, 7016, 7112		22NF		Rider Mower					Lawn Sport 16LS					
	7116, 7117, 7119		22NF		2005	YZ15334BUE	57	U1	190	Lawn Sport 18LS					
	7790		24		Riding Mowers										
	9020		70			Great Dane Rider			70	450					
	99075		B9-B		Tractor/Mower										
	990755, 990756		22NF		2007-06	250Z Series	57	U1	230						
	990757, 990758		22NF		2007-06	350Z Series	57	U1	340						
	990759		22NF		2007-06	450Z Series	57	U1	340						
	990780		U1		2007-06	GT500 Series	57	51	500						
Lawn Tractors					2007-06					LT200/300 Series					
	2005-00	Baron	U1	340	2007-06					YT400 Series					
	2014-00	Broadmoor	57	U1	340	Utility Vehicles									
	2005-99	Express	U1	200	2004-02					Snapper Grounds Cruiser					
	2014-06	Regent	U1	230	Vacuums										
	2004-00	Regent	U1	230	Hi-Vac					U1R 210					
Mowers					Walk Behind Mowers										
	2004-02	Colt	U1R	365	32in. Hydro					U1					
	2004-02	Lancer	U1	230	32in. Gear					U1					
Rear Engine Riders					All Pro Express					U1					
	2014-97	Coronet	U1	230	All Pro Hydro					U1					
Riding Rotary Turf Mowers					Walk Mowers										
	2004-97	Derby Morgan	57	U1	335	21401PS, 21401S					BTX4L-BS				
	2004-97	Morgan	57	U1	335	214X1PS					BTX4L-BS				
Zero-Turn Mowers					Yard Cruisers										
	2009-08	Axion	U1	350	HZS 15422					U1 190					
	2009-04	Champion 20/44	U1	340	HZS 15423					U1 190					
	2009-04	Champion 20/50	U1	340	HZS 18482					U1 190					
	2011-10	Champion 26/52	U1	340	HZS 18483					U1 190					
	2014-12	Champion 27/52	U1	340	YZ 145332					U1 190					
	2009-04	Citation 22/48	U1	340	YZ 145333					U1 190					
	2014-12	Citation 22/52	U1	340	YZ 14538					U1 190					
	2009-04	Citation 23/52	U1	340	Zero-Turn Mowers										
	2011-10	Citation 25/52	U1	340	2014-13					200Z 18/42"					
	2014-12	Citation 26/52	U1	340	2014-13					200Z 20/42"					
	2014-10	Citation 28/61	U1	340	2014-13					200Z 21.5/42"					
	2009-04	Cobalt 27/61	U1	350	2014-12					200Z 21/42"					
	2014-10	Cobalt 30/61	U1	350	2014-12					200Z 22/46"					
	2014-12	Cobalt 32/61	U1	340	2014-12					285Z 26/52"					
	2008-05	Consumer Z	U1	400	2014-12					300Z 27/52"					
	2004-97	Derby Stallion	U1	340	2014-09					S200XTBV3261					
	2007-04	Javelin 20/38	U1	230	Zero-Turn Turf Cruiser Line										
	2007-04	Javelin 20/44	U1	230	All Fast Trak					U1 380					
	2007-04	Javelin 20/55	U1	230	Snapper Z					U1 380					
	2004-97	Stallion	U1	340	All Fastback					U1 380					
	2003-97	Zero Turn	U1	400	All Turf Cruiser					U1 380					
<b>SNAPPER</b>					Garden Tractors										
	2004-02	LT150H331BU	U1	195	MZM 2300,					ZF2501					
	2004-02	LT150H381BU	U1	195	ZM 2501					U1 380					
	2004-02	LT150HGKU	U1	195	ZMT 2500					U1 380					
	2004-02	LT160H42HBU	U1	195	ZT18440KH					U1 340					
	2004-02	LT180H42U2	U1	195	ZT20500BU					U1 340					
	2004-02	LT200H481BU2	U1	195											
Lawn & Garden Tractors					<b>SPEEDEX</b>										
	1233, 2650S		U1		Lawn & Garden Tractors										
	2652S, 265XS		U1		1020, 1030, 1240					U1					
	266XS, 267XS		U1		1240M, 1320, 1330					U1					
	2680S, 308XS		U1		1632, 1640, 1640M					U1					
	350XS, 417XS		U1		1722, 1732, 1822					U1					
	418RS, 418XS		U1												
					Zero-Turning Radius, Three Wheel										
					1642H, 1650H					U1 265					
					1850H, 2060H					U1 265					
					A12V8S, AZ2/AZV					U1 265					
					AZV-12V-8S					U1 265					
					AZV-6					U1 265					

# Lawn & Garden / Small Engine

YEAR	MODEL	FOOT NOTE	GROUP/ TYPE NO.	O.E. CCA (@0°F)	YEAR	MODEL	FOOT NOTE	GROUP/ TYPE NO.	O.E. CCA (@0°F)	YEAR	MODEL	FOOT NOTE	GROUP/ TYPE NO.	O.E. CCA (@0°F)
<b>SYCAMORE MFG. CO.</b>					<b>TORO (Cont.)</b>					<b>TORO/WHEEL HORSE (Cont.)</b>				
Lawn & Garden Equipment					Zero-Turn Mowers (Cont.)					Lawn Tractors (Cont.)				
	732E		U1		2014-12	Z Master Professional 6000 Series		U1	300		15-38 HXL		U1	155
<b>TORO</b>					<b>TORO/WHEEL HORSE</b>									
Garden Tractors					260 Series Lawn Tractors					Midsize Walk Behind Mowers				
2014-06	GT2100, GT2200		U1	300		265-6		U1	210		All Models		U1	300
2006	GT2300		U1	300		265-8, 265-H		U1	300		Rear Engine Riders			
Lawn Equipment					300 Series Lawn Tractors					Riding Mowers				
2004	2100, 2110		U1	300		312-8		U1	210		11-32, 12-32, 13-32		U1	155
2003-02	300 Series		U1	230		314 Hydro		U1	300		21-42		U1	235
2007-04	3100		24	370		314-8		U1	210		8-25		U1	155
2007-04	315 - 8		U1	230		314-H		U1	300		Turf Sweeper			
2007-04	3200		24	370		315-8		U1	195		Toro Turf Sweeper w/18 Hp Kohler			
2007-04	3300		70	630		368-H		U1			Utility Vehicles			
2003-02	400 XT Series		U1	230		400 Series Lawn Tractors					Twister 1400			
2007-04	4100 - D, 4700 - D		24	650		415-H		U1	340		Twister 1600			
2007-04	520XI, 522XI	57	U1	425		416-8		U1	300		Walk-Behind-Hydro Drives			
2007-04	580 - D		24	650		416XT		U1	260		30187, 30189			
2007	Grounds Master		24	650		417XT, 419XT		U1	340		30192, 30159			
2007-04	Rough Mowers - 4500 - D		24	650		518xi, 520-Hydro		U1	340		Walk-Behinds-Gear Drives			
2007-02	Time Cutter 2	57	U1	290		520Lxi, 520xi		U1	340		30167, 30177			
2007-02	Time Cutter 2X	57	U1	290		522xi		U1	340		30182, 30183			
2003-02	Wheel Horse 5XI Series	57	U1	425		523Dxi (Diesel)		26	495		Zero-Turn Radius Mowers, Commercial			
2007-02	Workman 1100		U1	300		Commercial Riding Mowers					400 Series			
2007	Z Series		24	650		58 Pro, 70 Pro		U1			500 Series (Diesel)			
Riding Reel Mowers					Dingo Models					Zero-Turn Radius Mowers, Consumer				
2014-04	Reel Master 4000 - D		24	650		Front Runner		22NF			14-38Z, 15-44Z			
2006-99	Reel Master 5200 - D		26	530		GM-120		U1	300		16-42Z, 16-44Z			
2014-04	Reel Master 5210		26	530		Ground Master 117 Series		U1			17-44Z, 17-52Z			
2006-04	Reel Master 5400 - D		26	530		Ground Master 120 Series		U1			18-44Z, 18-44ZX			
2014-04	Reel Master 5410		26	530		Ground Master 200 Series		26			19-52ZX			
2006-04	Reel Master 5500 - D		26	530		Ground Master 220 Series		26R			<b>TROY BUILT</b>			
2014-04	Reel Master 5510		26	530		Ground Master 300 Series		26			Garden Tractors			
2014-04	Reel Master 5610		26	530		Ground Master 52 Series		26R			2005-98 GXT 16HP			
2014-04	Reel Master 6500 - D		24	650		Ground Master 72 Series		24			2005-98 GXT 18HP			
2014-04	Reel Master 6700 - D		24	650		Pro Line 37 walk-behind		U1			2005-97 GXT 20HP			
Riding Rotary Turf Mowers					Fairway Mowers					Lawn & Garden Tractors				
2014-05	Grounds Master 3280-D		26	525		Reel Master 4000-D		24	650		Lawn & Garden Tractors			
2014-04	Grounds Master 328-D		24	550		Rough Mowers - 4500-D		24	650		11-32, 12-32XL			
2014-05	Grounds Master 3320-G		26	525		Time Cutter 2, @X		U1	290		13 Hp, 13 Hp Gear			
2014-99	Grounds Master 3500-D		55	580		Lawn & Garden Tractors					1998			
2014-04	Grounds Master 4000-D		24	660		1000-L		26			13,000 Series			
2014-04	Grounds Master 4100-D		24	660		10-32, 210, 212		U1			13-32, 13-38XL			
2014-04	Grounds Master 4500-D		24	660		216, 310, 37300		U1			14-38-HXL, 15 Hp			
2014-04	Grounds Master 4700-D		24	660		37351, 55150		U1			15 Hp Gear, 16 Hp			
Zero-Turn Mowers					Lawn Tractors					Tillers				
2014-12	Grandstand 36"		U1	300		55151, 55152		U1			2003			
2014-12	Grandstand 40"		U1	300		56027, 56033		U1			Horse & Big Red Horse Rototillers			
2014-12	Grandstand 48"		U1	300		56044, 57356		U1			1996			
2014-12	Grandstand 52"		U1	300		57360, 612, 620		U1			Pony Rototiller			
2014-12	Grandstand 60"		U1	300		724, 8-32, Big Red		U1			Pony Rototiller			
2014-10	Grounds Master 360		26	525		CT7, LT6, LT7		U1			<b>TRU-TEST</b>			
2014-06	Grounds Master 7200		26	540		TE10, TE12		U1			All Others			
2010-06	Grounds Master 7210		26	540		Lawn & Garden Tractors					All, 10365, 2-832			
2014-11	Z Master Commercial 2000 Series		U1	300		Lawn Tractors					Lawn & Garden Tractors			
2014-11	Z Master Commercial 3000 Series		U1	300		12-32 XL, 13-38 XL		U1	155		6-1036, 7-1036			
2014-11	Z Master Professional 5000 Series		U1	300		14-38 HXL		U1	155		8325, 12 Hp/36			
					<b>TURFMASTER</b>									
					Commercial Mowers					12 Hp/39, 18 Hp/42				

# Lawn & Garden / Small Engine

YEAR	MODEL	FOOT NOTE	GROUP/ TYPE NO.	O.E. CCA (@0°F)	YEAR	MODEL	FOOT NOTE	GROUP/ TYPE NO.	O.E. CCA (@0°F)	YEAR	MODEL	FOOT NOTE	GROUP/ TYPE NO.	O.E. CCA (@0°F)
<b>ULTRA</b>					<b>WHEEL HORSE (Cont.)</b>					<b>WOODS (Cont.)</b>				
Lawn & Garden Equipment					Riding Mowers (Cont.)					Zero-Turn Radius Riders				
	15.5 Hp/42		U1	250		C81, Charger V7		U1			5182		U1	245
	17 Hp/46, 19 Hp/46		U1	250		Charger V8		U1		<b>YAMAHA</b>				
	20 Hp/46		U1	250		Commando 8		U1		Yard Tractors				
<b>VECTRAL</b>					<b>WHITE OUTDOOR</b>					<b>YANMAR</b>				
Riding Mowers					Garden Tractors					Lawn & Garden Equipment				
	11.5 Hp/30 Rider		U1	165		GT-1000		B50-N18L-A			GT14, YM140		51	
Tractors					Lawn Tractors					YARD MACHINE (BY MTD)				
	13 Hp/40 Tractor		U1	165		GT-1050		26R		Garden Tractors				
	15 Hp/42 Tractor		U1	165		GT-185, GT-205		B50-N18L-A			12.5 Hp 38in.		U1	230
	16.5 Hp/42 Tractor		U1	165		GT-2055		U1	190		14.5 Hp 42in.		U1	230
<b>VENTRAC</b>					2000-99					2004-99				
Lawn Tractors					2004-99					1999-97				
	2014-06 3100, 3200		22NF	410		GT-2150, GT-2550		U1	190		18 Hp 46in.		U1	230
	2004-01 4100		22NF	410		GT-225		U1	190		18.5 Hp 46in.		U1	230
	2014-05 4100 VXD		22NF	410		GT-2550 H		B50-N18L-A			L.U.V. Bug Riding Mower 6.5 Hp 24in.	B14L-A2		
	2014-01 4200 VXD		22NF	410	Lawn Tractors					Hydrostatic Lawn Tractors				
	2014-07 7200		22NF	410		L-15, LT-11650		U1			16.5Hp 42in.		U1	230
<b>VOELLER INC.</b>					2000-99					<b>YARD MAN</b>				
Lawn & Garden Equipment					2004-01					Garden Tractors				
	SS-7		U1			LT-125		B50-N18L-A	190		2005-97 U804H		U1	270
<b>WALKER</b>					2004-99					1999-97				
Zero-Turn Mowers					2004-01					2005-98				
	2014-12 MBK 23-HP		U1	300		LT-1300, LT-1450		U1	190		1999-97 Y804P		U1	270
<b>WALKER MOWERS</b>					2004-99					Lawn & Garden Tractors				
Lawn & Garden Equipment					2000-99					2005-98				
	All		U1	235		LT-135		B50-N18L-A	190		2005-98 W804H		U1	270
<b>WEED EATER (POULAN/YARD PRO)</b>					2000-99					2004-99				
Lawn Tractors					2004-99					Mowers				
	WE 12538		U1			LT-14		U1	190		1600			
	WE 14542		U1			LT-15		U1	190		165			
	WE 1642		U1R			LT-1500, LT-1650		U1	190		1650			
	WE 185H42		U1R			LT-155, LT-160		B50-N18L-A			180, 1800, 2000			
<b>WESTERN INTERNATIONAL (DYNAMARK)</b>					2000-99					Rear Engine Riders				
Riding Lawn Mowers					2004-99					2011-00				
	320000 Series		B14L-A2			LT-1600		U1	190		LR927		U1	190
	360000 Series		B14L-A2			LT-165		B50-N18L-A			<b>Zero-Turn Mowers</b>			
	421101, 456301		B14L-A2			LT-1800		U1	190		2004-00 ZT-1850			
<b>WHEEL HORSE</b>					2000-99					2004-00				
260 Series					2004-00					WILKOV (WISC. ENGINEERING)				
	265-6, 265-H		U1	300		LT-1850, LT-2150		U1	190	Lawn Mowers				
<b>300/400 Series</b>					2000-99					Utility Tractors				
	312-8, 314-8		U1	210		1515, 2500, 2512		U1	190		5000, 5013, 5032		31A	725
	314-H, 416-8		U1	210		2516, 2520, 4320		U1	190		5033		31A	725
<b>Garden Tractors</b>					<b>WISCONSIN MARINE</b>					<b>WOODS</b>				
	12-32XL, 13-38XL		U1	235	Lawn & Garden Equipment					Commercial Mowers				
	14-38HXL		U1	235		Jaquar 61		26R			1250		U1	245
	16-44HXL		U1	235	<b>WOODS</b>					Zero-Turn Mowers				
	C100, C120, C160		22NF	410	Riding Mowers					2000-99				
	Charger 10		22NF	410		108-3, 108-5, 111-5		B14L-A2			1850		U1	450
	Charger 12		22NF	410		11-32, 13-32, 211		U1			1999-95 6140		U1	245
	Electro 12, GT14		22NF	410		212, 21-42, 308		U1			1998-95 6160		U1	245
	Raider 10		22NF	410		310, 312, 414, 416		U1			2003-95 6180, 6200, 6215		U1	245
	Raider 12		22NF	410		418, 420, 8-25		U1			2003-97 6210		U1	245
<b>Riding Mowers</b>					2000-99					2003-97				
	108-3, 108-5, 111-5		B14L-A2			A115		B14L-A2			1999-98 6225		U1	245
	11-32, 13-32, 211		U1			A50, A80, A81		U1			2003-95 6250		U1	245
	212, 21-42, 308		U1			A85		B14L-A2			2003-99 M2250, M2560		U1	245
	310, 312, 414, 416		U1			B100, B80, B81		U1			2002-99 R1540		U1	245
	418, 420, 8-25		U1			C101, C121, C141		U1						
	A115		B14L-A2			C161, C161 Twin		U1						

# Lawn & Garden / Small Engine

YEAR	MODEL	FOOT NOTE	GROUP/ TYPE NO.	O.E. CCA (@0°F)	YEAR	MODEL	FOOT NOTE	GROUP/ TYPE NO.	O.E. CCA (@0°F)
<b>YAZOO/KEES</b>					<b>YAZOO/KEES (Cont.)</b>				
<b>Commercial Riding Mowers</b>					<b>Zero-Turn Mowers (Cont.)</b>				
	27.5 Hp Diesel Eagle V		24		2009-04	ZVKW61252 (Max 2)		U1	245
	TR42		24		<b>ZAPPER</b>				
	TYK25		26R	430	<b>Lawn &amp; Garden Equipment</b>				
	YHR16B		26DT			TS-14, TS-18		U1	250
	YHR18.5W		26R			TS-20, TS-2093K		U1	250
	YHR23K		26R			TS-22, TS-2293		U1	250
	YHRLD 25		26DT	430		TS-25, TS-950-D		U1	250
	YR 30, YR3012BE		U1	365		TS-950-G		U1	250
	YR308BE		U1	365	<b>ZIPPER</b>				
	YR36, YR48, YR60		26R		<b>Lawn Tractor/Mower</b>				
	YR76		26R						
	YTBSB 18		70		2007-02	TS - 20, TS - 22		U1	250
	YTBS-D265		26DT	430	2004-02	TS - 25		U1	250
	YTKC22, YTKC25		26DT	430					
	YTKCZ 22		70						
	YTVSB18		26DT	430					
	YZTK 20		U1	365					
<b>Dig-It Models</b>									
	148, 158		22NF						
<b>Walk-Behind Mowers</b>									
	YHRK230		26DT	430					
	YHRLD212		26DT	430					
	YHRLK20		26DT	430					
	YHRLK23		26DT	430					
<b>Zero-Turn Mowers</b>									
2008-06	ZCBI48180 (Consumer Z)		U1	245					
2009-06	ZEKW42170 (Esteem Series)		U1	245					
2009-06	ZEKW52210 (Esteem Series)		U1	245					
2009-04	ZHDD61271 (Mega Max)		U1	245					
2009-04	ZHDD72341 (Mega Max)		U1	245					
	ZKH52222		U1	245					
2003-98	ZKHP52233		U1	245					
2003-99	ZKHP52253		U1	245					
2003-98	ZKHP61253		U1	245					
	ZKW 42170		U1	245					
	ZKW 48170		U1	245					
	ZKW 52252		U1	245					
	ZKW 61252		U1	245					
2003-99	ZKW52233		U1	245					
2003-99	ZKW61233		U1	245					
2003-00	ZKWQL42171		U1	245					
2003-98	ZKWQL48171		U1	245					
2003-98	ZKWQL48191		U1	245					
2009-04	ZMB48181 (Mid Max)		U1	245					
2009-04	ZMKH52231 (Mid Max)		U1	245					
2009-06	ZMKW48171 (Mid Max)		U1	245					
2009-04	ZMKW48191 (Mid Max)		U1	245					
2009-04	ZMKW52211 (Mid Max)		U1	245					
2011-10	ZMKW5222		U1	245					
2009-04	ZMKW52231 (Mid Max)		U1	245					
2009-04	ZMKW61231 (Mid Max)		U1	245					
2011-10	ZMKW6124		U1	245					
2011-10	ZPKW5426		U1	245					
2011-10	ZPKW6029		U1	245					
2009-04	ZVHO61242 (Max 2)		U1	245					
2009-04	ZVKH61272 (Max 2)		U1	245					
2011-10	ZVKH61273		U1	245					
2009-04	ZVKH72272 (Max 2)		U1	245					
2009-06	ZVKH72302 (Max 2)		U1	245					
2009-06	ZVKJ61302 (Max 2)		U1	245					
2009-04	ZVKW52252 (Max 2)		U1	245					

# POWERSPORT - Motorcycle & Scooter

ENGINE	YEAR	MODEL	JIS Battery Type	ENGINE	YEAR	MODEL	JIS Battery Type	ENGINE	YEAR	MODEL	JIS Battery Type
<b>Motorcycle &amp; Scooter</b>				<b>APRILIA (Cont.)</b>				<b>BIG DOG (Cont.)</b>			
<b>AMERICAN IRONHORSE</b>											
1820cc	2000	Bandit	BTX20L-BS	125cc	2007-99	Scarabeo 125	B12AL-A	1900cc	2005	Chopper DT	BTX20L-BS
	2002-00	Classic	BTX20L-BS		2011-08	Sportcity 125	B9-B		2005	Chopper RT	BTX20L-BS
	2007-01	Legend	BTX20L-BS		2005-04	Tuono 125	B9-B		2011-09	Coyote	BTX20L-BS
	2007-05	LSC	BTX20L-BS	100cc	2011-02	Scarabeo 100	B9-B	1800cc	2011	Bulldog Sport	BTX20L-BS
	2007-00	Outlaw	BTX20L-BS	50cc	2007-99	Mojito Custom 50	B4L-B	1750cc	2004-01	Boxer	BTX20L-BS
	2002-01	Ranger	BTX20L-BS		2003-99	Mojito Retro 50	B4L-B		2004-01	Bulldog	BTX20L-BS
	2003	Ranger T	BTX20L-BS		2004-95	Rally 50 (Air Cooled)	B4L-B		2004-03	Chopper	BTX20L-BS
	2009-07	Slammer	BTX20L-BS		2007-02	RS 50	B4L-B		2004-03	Chopper DT	BTX20L-BS
	2005-00	Slammer	BTX20L-BS		2006-95	Scarabeo 50 2T	B4L-B		2003-01	Husky	BTX20L-BS
	2004-03	Stalker	BTX20L-BS		2007-02	Scarabeo 50 4T	B9-B		2004-01	Mastiff	BTX20L-BS
	2000	Stalker	BTX20L-BS		2004-01	Scarabeo 50 Ditech	B4L-B		2004-01	Pitbull	BTX20L-BS
	2007-01	Tejas	BTX20L-BS		2011-09	Sportcity 50	B9-B		2002-01	Pro Sport	BTX20L-BS
	2009-03	Texas Chopper	BTX20L-BS		2013-12	SR 50	B9-B		2004	Ridgeback	BTX20L-BS
	2002-00	Thunder	BTX20L-BS		2004-02	SR 50 Ditech	BTX5L-BS		2001	Vintage Sport	BTX20L-BS
1640cc	2009-08	Bandera	BTX20L-BS		2013	SR 50 R Replica SBK	B9-B		2002-01	Wolf	BTX20L-BS
	2008	Classic Chop	BTX20L-BS		2013	SR Motard 50	B9-B	<b>BIMOTA</b>			
	2009	Judge	BTX20L-BS		2011-06	SR50R Factory	B9-B	1000cc	2001-98	SB8R	BTX12-BS
					2005-04	Tuono 50	B4L-B	<b>BMW</b>			
<b>APRILIA</b>				<b>ATK</b>							
1200cc	2012-11	Dorsoduro 1200	BTX14-BS	605cc	2000-96	605 CC	BTX7L-BS	1600cc	2014-11	K1600GT	BT19BL-BS
1000cc	2007-01	ETV 1000 Caponord	BTX14-BS		1995	605 CC	BTX9-BS		2014	K1600GT Sport	BT19BL-BS
	2005-01	RST1000 Futura	BTX12-BS		1997-96	605 DS	BTX7L-BS		2014-11	K1600GTL	BT19BL-BS
	2009-05	RSV 1000 R	BTX12-BS		1995	605 DS	BTX9-BS	1300cc	2010-09	K1300GT	BT19BL-BS
	2009-04	RSV 1000 R Factory	BTX12-BS		2001-98	605 Enduro	BTX7L-BS		2011-09	K1300R	BTX14-BS
	2004-98	RSV Mille	BTX12-BS		1998-96	605 LE	BTX7L-BS		2014-09	K1300S	BTX14-BS
	2004-00	RSV Mille R	BTX12-BS	600cc	2001-98	600 DT	BTX7L-BS		2013	K1300S 30 Jahre K-Modelle	BTX14-BS
	2003	RSV Mille R Haga	BTX12-BS		2001-00	600 MT	BTX7L-BS	1200cc	2008-03	K1200GT	BT19BL-BS
	2004	RSV Mille R Nera	BTX12-BS	500cc	1999	500 DT	BTX7L-BS		2009-98	K1200LT	BT19BL-BS
	2000	RSV Mille SP	BTX12-BS	490cc	2000-99	490 CC	BTX7L-BS		2003	K1200LT Exodus	BT19BL-BS
	2010	RSV4 Factory	BTZ10S		2000-99	490 Enduro	BTX7L-BS		2002-99	K1200LTC	BT19BL-BS
	2013	RSV4 Factory APRC	BTZ10S	406cc	1996	406 CC	BTX7L-BS		2001-99	K1200LTI Icon	BT19BL-BS
	2012-11	RSV4 Factory SE	BTZ10S		1995	406 CC	BTX9-BS		2000-99	K1200LTS	BT19BL-BS
	2012-10	RSV4 R	BTZ10S	350cc	1999-96	350 CC	BTX7L-BS		2008-05	K1200R	BTX14-BS
	2013	RSV4 R APRC ABS	BTZ10S		1995	350 CC	BTX9-BS		2008-07	K1200R Sport	BTX14-BS
	2004-00	SL1000 Falco	BTX14-BS		1997-96	350 DS	BTX7L-BS		2005-97	K1200RS	BT19BL-BS
	2011-04	Tuono 1000 R	BTX12-BS		1995	350 DS	BTX9-BS		1999	K1200RS Dakar	BT19BL-BS
	2010-07	Tuono 1000 R Factory	BTX12-BS		1999-98	350 Enduro	BTX7L-BS		2008-05	K1200S	BTX14-BS
	2005-04	Tuono 1000 R Factory	BTX12-BS	260cc	2001-00	260 Enduro	BTX7L-BS		2002-98	R1200C	BT19BL-BS
	2003	Tuono Fighter 1000	BTX12-BS		1999-96	260 LQ	BTX7L-BS		2003-00	R1200C Avantgarde	BT19BL-BS
	2003	Tuono Racer 1000	BTX12-BS	250cc	1996	250 CC	BTX7L-BS		2005-96	R1200C Classic	BT19BL-BS
	2012	Tuono V4 R	BTZ10S		1995	250 CC	BTX9-BS		2002-98	R1200C Euro	BT19BL-BS
	2013	Tuono V4 R APRC	BTZ10S		2001	250 Enduro	BTX7L-BS		2004-00	R1200C Independent	BT19BL-BS
850cc	2012-08	Mana 850	BTX14-BS		2000-96	250 LQ	BTX7L-BS		2003-00	R1200C Montana	BT19BL-BS
	2013-09	Mana 850 GT ABS	BTX14-BS		1995	250 LQ	BTX9-BS		2005-04	R1200C Montauk	BT19BL-BS
750cc	2012-10	Dorsoduro 750	BTX14-BS		2000	250 LQ MT	BTX7L-BS		2002-00	R1200C Phoenix	BT19BL-BS
	2013	Dorsoduro 750 ABS	BTX14-BS	125cc	2001	125 CC	BTX7L-BS		2001	R1200C Stiletto	BT19BL-BS
	2013-10	Shiver 750	BTX12-BS		2000	125 LQ	BTX7L-BS		2006-02	R1200CL	BT19BL-BS
	2009-08	SL 750 Shiver	BTX14-BS	50cc	2000-99	50 CC	BTX7L-BS		2014	R1200GS	BTX14-BS
	2009	SMV 750 Dorsoduro	BTX14-BS		2001-99	50 MX	BTX7L-BS		2010-04	R1200GS	BTX14-BS
650cc	2007	Pegaso 650	BTX12-BS	<b>BENELLI</b>					2013	R1200GS (From 06/2013)	BTX14-BS
	2002-96	Pegaso 650	B12AL-A	1130cc	2007	Cafe Racer 1130	BTZ14S		2012-11	R1200GS (Production Code 0460)	BTX14-BS
	2002-01	Pegaso 650 (Additional Battery for Police Version)	BTX9-BS	<b>BETA</b>					2012-11	R1200GS (Production Code 0A11)	BTZ14S
	2007	Pegaso 650 Factory	BTX12-BS	525cc	2009-08	525 RR	BTX5L-BS		2013	R1200GS (Up to 06/2013)	BTZ14S
	2007-06	Pegaso 650 Trail	BTX12-BS		2009-08	525 RS	BTX5L-BS		2013-10	R1200GS Adventure	BTZ14S
550cc	2012	RXV 550	BTX7A-BS	450cc	2009-08	450 RR	BTX5L-BS		2009-06	R1200GS Adventure	BTX14-BS
	2009-06	RXV 550	BTX7A-BS		2009-08	450 RS	BTX5L-BS		2009-08	R1200GS Adventure (Optional)	BTZ14S
	2012-06	SXV 550	BTX7A-BS	400cc	2009-08	400 RR	BTX5L-BS		2007-06	R1200GS HP2	BTX14-BS
500cc	2004-01	Atlantic 500	B14L-A2	<b>BIG DOG</b>					2014-06	R1200R	BTX14-BS
	2011-07	Scarabeo 500 ie	B4L-B	1920cc	2011-10	Bulldog	BTX20L-BS		2011	R1200R Classic	BTX14-BS
450cc	2012-06	RXV 450	BTX7A-BS		2007	Bulldog	BTX20L-BS		2013-05	R1200RT	BT19BL-BS
	2012	SXV 450	BTX7A-BS		2005	Bulldog	BTX20L-BS		2007-06	R1200S	BTX14-BS
	2009-06	SXV 450	BTX7A-BS		2011-06	K-9	BTX20L-BS		2007-05	R1200ST	BTX14-BS
250cc	2002-96	RS 250	B4L-B		2011	K-9 250	BTX20L-BS		2006-04	RG1200GS	BTX14-BS
	2006-04	Scarabeo 250	B12AL-A		2011-10	K-9 EFI	BTX20L-BS		2008-07	HP2 Enduro	BTZ14S
	2011-07	Sportcity 250	BTX12-BS		2011-05	Mastiff	BTX20L-BS		2008-07	HP2 Enduro (w/alarm system code X603A)	BTZ12S
200cc	2009	Sportcity Cube 250	BTX12-BS		2011-10	Mastiff EFI	BTX20L-BS		2009-08	HP2 Megamoto	BTZ14S
150cc	2011-08	Scarabeo 200	B12AL-A		2008	Mult	BTX20L-BS		2009-08	HP2 Megamoto (w/ alarm system code X603A)	BTZ12S
	2007	Mojito 150	BTX7L-BS		2011-05	Pitbull	BTX20L-BS		2010-08	HP2 Sport	BTZ14S
	2004-99	Scarabeo 150	B12AL-A		2011-09	Wolf	BTX20L-BS				
125cc	2009	RS 125	B9-B	1915cc	2011-08	Ridgeback	BTX20L-BS				
	2007-06	RS 125	B9-B		2006-05	Ridgeback	BTX20L-BS				
	2002-97	RS 125	B9-B	1900cc	2007-06	Chopper	BTX20L-BS				
					2005	Chopper BDM	BTX20L-BS				

# POWERSPORT - Motorcycle & Scooter

ENGINE	YEAR	MODEL	JIS Battery Type	ENGINE	YEAR	MODEL	JIS Battery Type	ENGINE	YEAR	MODEL	JIS Battery Type
<b>BMW (Cont.)</b>				<b>BMW (Cont.)</b>				<b>CANNONDALE</b>			
1170cc	2010-08	HP2 Sport (w/alarm system code X603A)	BTZ12S	650cc	2005-03	F650CS ABS	B12AL-A	440cc	2005-02	C440R	BTZ7S
1150cc	2004-99	R1150GS	BT19BL-BS	2012-08	F650GS	BTX14-BS		2005-02	E440		BTZ7S
	2005-02	R1150GS Adventure	BT19BL-BS	2006-01	F650GS	B12AL-A		2005-03	E440A		BTZ7S
	2003	R1150GS Sport	BT19BL-BS	2007	F650GS (9/2007 On)	BTX14-BS		2005-03	E440R		BTZ7S
	2006-01	R1150R	BT19BL-BS	2007	F650GS (Up to 9/2007)	B12AL-A		2005-03	S440		BTZ7S
	2006-02	R1150R Roadster	BT19BL-BS	2005	F650GS ABS	BTX14-BS		2005-02	X440		BTZ7S
	2004-01	R1150RS	BT19BL-BS	2003-01	F650GS ABS	BTX14-BS		2001-00	MX400		BTZ7S
	2005-01	R1150RT	BT19BL-BS	2007-01	F650GS Dakar	B12AL-A		<b>DUCATI</b>			
1100cc	1999-95	K1100LT	BT19BL-BS	2005-02	F650GS Dakar ABS	B12AL-A		1200cc	2013-10	Multistrada 1200	BT12B-4
	1997	K1100LT High Line	BT19BL-BS	1999-97	F650ST	B12AL-A		2011-10	Multistrada 1200 S		BT12B-4
	1997	K1100LT Special Edition	BT19BL-BS	2007	G650 Xchallenge	BTZ10S		2013	Multistrada 1200 S Granturismo		BT12B-4
	1996-95	K1100RS	BT19BL-BS	2009-07	G650 Xcountry	BTZ10S		2013-12	Multistrada 1200 S Pikes Peak		BT12B-4
	1996	K1100RS SE	BT19BL-BS	2007	G650 Xmoto	BTZ10S		2012	Multistrada 1200 S Sport		BT12B-4
	1995	R1100GS	BT19BL-BS	2014-09	G650GS	B12AL-A		2013-12	Multistrada 1200 S Touring		BT12B-4
	1999-95	R1100GS ABS	BT19BL-BS	2014-12	G650GS Sertao	B12AL-A		1199cc	2013-12	1199 Panigale	BT7B-BS
	1999	R1100GS SE	BT19BL-BS	2014-13	C600 Sport	BTX14-BS		2013	1199 Panigale R		BT7B-BS
	2000-95	R1100R	BT19BL-BS	2010-08	G450X	BTZ7S		2013-12	1199 Panigale S		BT7B-BS
	1999	R1100R SE	BT19BL-BS	<b>BUELL</b>				2013-12	1199 Panigale S Tricolore		BT7B-BS
	2001	R1100RL	BT19BL-BS	1200cc	2002-97	M2 Cyclone	BTX20L-BS	1198cc	1198		BT12B-4
	2001-95	R1100RS ABS	BT19BL-BS	2002	M2L Cyclone	BTX20L-BS		2011-10	1198 R Corse		BT12B-4
	1996-95	R1100RSL	BT19BL-BS	1998-96	S1 Lightning	BTX14-BS		2010-09	1198 S		BT12B-4
	2001-95	R1100RT	BT19BL-BS	1998	S1 White Lightning	BTX14-BS		2010	1198 S Corse		BT12B-4
	2000	R1100RT SE	BT19BL-BS	1996-95	S2 Thunderbolt	B16-B		2011	1198 SP		BT12B-4
	1997-96	R1100RTL	BT19BL-BS	1996	S2T Thunderbolt	B16-B		2013-11	Diavel		BT12B-4
	2005-98	R1100S	BT19BL-BS	2001-97	S3 Thunderbolt	BTX20L-BS		2012	Diavel AMG		BT12B-4
	2005-04	R1100S ABS	BT19BL-BS	2002-97	S3T Thunderbolt	BTX20L-BS		2013-12	Diavel Carbon		BT12B-4
	2002	R1100S ABS	BT19BL-BS	2002-99	X1 Lightning	BTX20L		2012	Diavel Cromo		BT12B-4
	1999	R1100S ABS	BT19BL-BS	2002	X1W White Lightning	BTX20L		2013	Diavel Dark		BT12B-4
	2002	R1100S Boxer Cup	BT19BL-BS	2010-04	XB12R Firebolt	BTX14		2013	Diavel Strada		BT12B-4
	2005-03	R1100S Boxer Cup Replica	BT19BL-BS	2008-04	XB12S Lightning	BTX14		2009-08	Hypermotard 1100		BT12B-4
	2001-00	R1100SA	BT19BL-BS	2010-05	XB12Scg Lightning	BTX14		2011-10	Hypermotard 1100 EVO		BT12B-4
	2000	R1100SA SE	BT19BL-BS	2010-07	XB12Ss Lightning Long	BTX14		2012-10	Hypermotard 1100 EVO SP		BT12B-4
1000cc	2014-13	HP4 (w/Alarm System)	BTZ10S	2007	XB12STT Lightning	BTX14		2009-08	Hypermotard 1100 S		BT12B-4
	2014-13	HP4 (w/o Alarm System)	BTZ7S	2008	XB12STT Lightning Super	BTX14		2011-09	Monster 1100		BT12B-4
	2014	HP4 Competition (w/ Alarm System)	BTZ10S	2010-06	XB12X Ulysses	BTX14		2013-12	Monster 1100 EVO		BT12B-4
	2014	HP4 Competition (w/o Alarm System)	BTZ7S	2010-09	XB12XP Ulysses Police	BTX14		2011-09	Monster 1100 S		BT12B-4
	1995	R100GS	53030	2010-09	XB12XT Ulysses	BTX14		2009-07	Multistrada 1100		BT12B-4
	1995	R100GS Paris-Dakar	53030	2010-09	1125CR	BTX14L		2009-07	Multistrada 1100 S		BT12B-4
	1995	R100R	53030	2010-08	1125R	BTX14L		2009-07	Multistrada 1100 S		BT12B-4
	1995	R100RT	53030	2010-05	Lightning CityX XB9SX	BTX14		2011-09	Streelfighter		BT12B-4
	2014-12	S1000RR	BTZ10S	2003	XB9SX Lightning CityX	BTX14		2012-09	Streelfighter S		BT12B-4
	2011-09	S1000RR (Optional)	BTZ14S	2007-02	XB9R Firebolt	BTX14		2008-07	1098		BT12B-4
	2011-09	S1000RR (w/Alarm)	BTZ12S	2002	XB9R Firebolt (European)	BTX14-BS		2007	1098 (Early)		BTX14-BS
	2011-09	S1000RR (w/o Alarm)	BTZ10S	2004-03	XB9S Lightning	BTX14		2009-08	1098 R		BT12B-4
850cc	2003-00	R850C Avantgarde	BT19BL-BS	2004	XB9SL	BTX14		2009	1098 R Bayliss LE		BT12B-4
	2001-96	R850C Classic	BT19BL-BS	2010-05	XB9SX Lightning	BTX14		2008-07	1098 S		BT12B-4
	2001-00	R850C Euro	BT19BL-BS	2009-00	Blast	BTX14-BS		2007	1098 S (Early)		BTX14-BS
	2001-95	R850R	BT19BL-BS	<b>CAN-AM</b>				2007	1098 S Tricolore		BT12B-4
	1996	R850R ABS	BT19BL-BS	990cc	2008	Spyder GS (SE5)	BTX24HL	2007	1098 S Tricolore (Early)		BTX14-BS
	1997	R850R Special Edition	BT19BL-BS	2009-08	Spyder GS (SM5)	BTX24HL		2004-03	1000		BT12B-4
800cc	2014-08	F800GS	BTX14-BS	2013	Spyder RS (SE5)	BTX24HL		2006-05	1000DS		BT12B-4
	2014	F800GS Adventure	BTX14-BS	2011-09	Spyder RS (SE5)	BTX24HL		2010-07	GT1000		BT12B-4
	2014-13	F800GT	BTX14-BS	2013-09	Spyder RS (SM5)	BTX24HL		2009	GT1000 Touring		BT12B-4
	2014-13	F800GT (Auxiliary Battery)	BTZ14S	2013-11	Spyder RS-S (SM5)	BTX24HL		2005-04	Monster 1000		BT12B-4
	2013-09	F800R	BTX14-BS	2013	Spyder RT (SE5)	BTX24HL		2003	Monster 1000 Dark		BT12B-4
	2008-06	F800S	BTX14-BS	2010	Spyder RT (SE5)	BTX24HL		2005-03	Monster 1000s		BT12B-4
	2012-06	F800ST	BTX14-BS	2012-10	Spyder RT (SE5) Audio/Convenience	BTX24HL		2008-06	Monster S2R 1000		BT12B-4
750cc	1995	K75	BT19BL-BS	2013	Spyder RT (SM5)	BTX24HL		2007-06	Monster S4R		BT12B-4
	1995	K75/3	BT19BL-BS	2012-10	Spyder RT (SM5) Audio/Convenience	BTX24HL		2008-07	Monster S4R Testastretta		BT12B-4
	1995	K75/3A	BT19BL-BS	2013-10	Spyder RT Limited (SE5)	BTX24HL		2006	Monster S4Rs		BT12B-4
	1995	K75RT ABS	BT19BL-BS	2013-12	Spyder RT-S (SE5)	BTX24HL		2008-06	Monster S4Rs Testastretta		BT12B-4
	1995	K75S ABS	BT19BL-BS	2013-12	Spyder RT-S (SM5)	BTX24HL		2008	Monster S4Rs Tricolore		BT12B-4
700cc	2014-13	F700GS	BTX14-BS	2013	Spyder ST (SE5)	BTX24HL		2004-03	Multistrada 1000		BT12B-4
	2014-13	F700GS (Auxiliary Battery)	BTZ14S	2013	Spyder ST (SM5)	BTX24HL		2006-05	Multistrada 1000 DS		BT12B-4
650cc	2014-13	C650GT	BTX14-BS	2013	Spyder ST Limited (SE5)	BTX24HL		2006	Multistrada 1000s DS		BT12B-4
	2000-97	F650	B12AL-A	2013	Spyder ST (SE5) Audio/Convenience	BTX24HL		2006-05	PaulSmart 1000 LE		BT12B-4
	2001-98	F650 Enduro	B12AL-A	2013	Spyder ST-S (SE5)	BTX24HL		2006	Sport 1000		BT12B-4
	1999	F650 SE	B12AL-A	2013	Spyder ST-S (SM5)	BTX24HL		2008-07	Sport 1000 Biposto		BT12B-4
	2006-01	F650CS	B12AL-A					2007	Sport 1000 Monoposto		BT12B-4

# POWERSPORT - Motorcycle & Scooter

ENGINE	YEAR	MODEL	JIS Battery Type	ENGINE	YEAR	MODEL	JIS Battery Type	ENGINE	YEAR	MODEL	JIS Battery Type
<b>DUCATI (Cont.)</b>				<b>DUCATI (Cont.)</b>				<b>GAS GAS</b>			
1000cc	2009-07	Sport 1000s	BT12B-4	796cc	2013-11	Monster 796	BT12B-4	370cc	1997	Pampera 370	BTX4L-BS
	2007-04	ST3	BT12B-4	795cc	2012	Monster 795	BT12B-4	250cc	1996-95	Pampera 250	BTX4L-BS
	2007-06	ST3S ABS	BT12B-4	750cc	2002-99	750	BT12B-4	<b>HARLEY DAVIDSON</b>			
999cc	2006-03	999	BT12B-4		2002-01	750 Sport	BT12B-4	1803cc	2011	FLHTCUSE6 CVO Ultra Classic Electra Glide	BTX30L
	2006-03	999R	BT12B-4		2011-10	Monster 750	BT12B-4		2010	FLHXSE CVO Street Glide	BTX30L
	2004-03	999R FILA	BT12B-4		2002-00	Monster 750	BT12B-4		2011	FLHXSE2 CVO Street Glide	BTX30L
	2006	999R Xerox	BT12B-4		1999-97	Monster 750	B16AL-A2		2012	FLHXSE3 CVO Street Glide	BTX30L
	2006-03	999S	BT12B-4		1999	Monster 750 City	B16AL-A2		2011	FLSTSE2 CVO Softail Convertible	BTX20L
998cc	2003-02	998 Biposto	BT12B-4		2002-01	Monster 750 Dark	BT12B-4		2012	FLSTSE3 CVO Softail Convertible	BTX20L
	2004	998 F Edition Biposto	BT12B-4		2000-99	Monster 750 Dark	B16AL-A2		2011	FLTRUSE CVO Road Glide Ultra	BTX30L
	2004	998 F Edition Monoposto	BT12B-4		1999	Monster 750 Dark City	B16AL-A2		2012	FLTRXSE CVO Road Glide Custom	BTX30L
	2004	998 Matrix	BT12B-4		2002-01	Monster 750 Metallic	BT12B-4		2013	FLTRXSE2 CVO Road Glide Custom	BTX30L
	2004-02	998 Monoposto	BT12B-4		2000	Monster 750 Metallic	B16AL-A2		2014-13	FXSBSE CVO Breakout	BTX20L
	2002	998R	BT12B-4	749cc	1997	SS 750	BT12B-4		2013	FLHRSE5 CVO Road King	BTX30L
	2002	998S	BT12B-4		2006-03	749	BT12B-4		2014	FLHRSE6 CVO Road King	BTX30L
	2002	998S Bayliss	BT12B-4		2006-05	749 Dark	BT12B-4		2007	FLHRSE3 Screamin Eagle Road King	BTX30L
	2002	998S Bostrom	BT12B-4		2006-04	749R	BT12B-4		2007	FLHTCUSE2 Screamin Eagle Ultra Classic Electra Glide	BTX30L
	2002	998S Monoposto	BT12B-4		2006-03	749S	BT12B-4		2008	FLHTCUSE3 Screamin Eagle Ultra Classic Electra Glide	BTX30L
996cc	2002	996	BT12B-4	748cc	2002-01	748	BT12B-4		2014	FLHTKSE CVO Limited	BTX30L
	2001	996 Biposto	BT12B-4		2000	748	B16AL-A2		2014	FLSTNSE CVO Softail Deluxe	BTX20L
	2000-99	996 Biposto	B16AL-A2		1999-97	748 Biposto	B16AL-A2		2009	FXDFSE CVO Dyna Fat Bob	BTX20L
	2001	996 Monoposto	BT12B-4		2002-01	748 Monoposto	BT12B-4		2007	FXDSE Screamin Eagle Dyna	BTX20L
	2000-99	996 Monoposto	B16AL-A2		2000	748 Monoposto	B16AL-A2		2008	FXDSE2 Screamin Eagle Dyna	BTX20L
	2000-99	996 SPS	B16AL-A2		1997	748 SP	B16AL-A2		2007	FXSTSSE Screamin Eagle Softail Springer	BTX20L
	1999	996 SPS Fogarty	B16AL-A2		1999-98	748 SPS	B16AL-A2		2008	FXSTSSE2 Screamin Eagle Softail Springer	BTX20L
	2001	996R	BT12B-4		2002	748R	B16AL-A2		2008	FLD Switchback	BTX20L
	2003-01	996S	BT12B-4		2001	748R	BT12B-4		2014-12	FLHR Road King	BTX30L
	2001	996S Monoposto	BT12B-4		2000	748R	B16AL-A2		2013-11	FLHRC Road King Classic	BTX30L
950cc	2003-01	ST2	BT12B-4		2002	748R Biposto	BT12B-4		2013-12	FLHTC Electra Glide Classic	BTX30L
	2000-97	ST2	B16AL-A2		2002-01	748S	BT12B-4		2005	FLHTCSE2 Screamin Eagle Electra Glide 2	BTX30L
920cc	2002-01	Monster S4	BT12B-4		2000	748S	B16AL-A2		2014-12	FLHTCU Electra Glide Ultra Classic	BTX30L
	2002	Monster S4 Fogarty	BT12B-4		2002-01	748S Monoposto	BT12B-4		2006	FLHTCUSE Screamin Eagle Ultra Classic Electra Glide	BTX30L
916cc	1998	916 Biposto	B16AL-A2	696cc	2013-08	Monster 696	BT12B-4		2013-11	FLHTCUTG Tri Glide Ultra Classic	BTX30L
	1998-97	916 Monoposto	B16AL-A2	695cc	2008-07	Monster 695	BT12B-4		2014-10	FLHTK Electra Glide Ultra Limited	BTX30L
	1998-97	916 Senna	B16AL-A2	620cc	2003	620 Sport	BT12B-4		2014-12	FLHX Street Glide	BTX30L
	1995-95	916 SP	B16AL-A2		2006-02	Monster 620	BT12B-4		2014	FLHXS Street Glide Special	BTX30L
	1998-97	916 SPS	B16AL-A2		2004	Monster 620 Capirex	BT12B-4		2011-10	FLHXXX Street Glide Trike	BTX30L
	1998	916 SPS Fogarty	B16AL-A2		2006-05	Monster 620 Dark	BT12B-4		2014-12	FLS Softail Slim	BTX20L
	1996	916 Strada	B16AL-A2		2004	Monster 620 Matrix	BT12B-4		2014-12	FLSTC Heritage Softail Classic	BTX20L
915cc	2004-03	ST4	BT12B-4		2003-02	Monster 620s	BT12B-4		2014-12	FLSTF Fat Boy	BTX20L
	2001	ST4	BT12B-4		2006-05	Multistrada 620	BT12B-4		2014-12	FLSTFB Fat Boy Lo	BTX20L
	2000-99	ST4	B16AL-A2		2006-05	Multistrada 620 Dark	BT12B-4		2005	FLSTFSE Screamin Eagle Fat Boy	BTX20L
	2005-01	ST4S	BT12B-4	600cc	2001	Monster 600	BT12B-4		2006	FLSTFSE2 Screamin Eagle Fat Boy	BTX20L
	2005	ST4S ABS	BT12B-4		2000-97	Monster 600	B16AL-A2		2014-12	FLSTN Softail Deluxe	BTX20L
900cc	2002-99	900	B16AL-A2		1999	Monster 600 City	B16AL-A2				
	1997	900	B16AL-A2		2001	Monster 600 Dark	BT12B-4				
	1998	900 Sport	B16AL-A2		2000-98	Monster 600 Dark	B16AL-A2				
	2002-00	MH900e	BT12B-4		2000-99	Monster 600 Dark City	B16AL-A2				
	2002-01	Monster 900	BT12B-4		2001	Monster 600 Metallic	BT12B-4				
	2000-97	Monster 900	B16AL-A2		2000	Monster 600 Metallic	B16AL-A2				
	1999	Monster 900 City	B16AL-A2	400cc	1997	400	B16AL-A2				
	2001	Monster 900 Cromo	BT12B-4		2002-97	Monster 400	B16AL-A2				
	2000-98	Monster 900 Cromo	B16AL-A2		2004-02	Monster 400 Dark	B16AL-A2				
	2002-01	Monster 900 Dark	BT12B-4		2001-00	Monster 400 Metallic	B16AL-A2				
	2000-98	Monster 900 Dark	B16AL-A2		2003	Monster 400s	B16AL-A2				
	1999	Monster 900 Dark City	B16AL-A2	<b>E-TON</b>							
	2001	Monster 900 Metallic	BT12B-4	150cc	2009-07	Beamer R4 (150)	BTX9-BS				
	2000	Monster 900 Metallic	B16AL-A2		2010	Matrix 150	BTX9-BS				
	2001	Monster 900s	BT12B-4		2009	Matrix R4-150	BTX9-BS				
	2000-98	Monster 900s	B16AL-A2		2010-09	Sport 150	BTX7A-BS				
	1998	SS 900	BT12B-4	50cc	2011	Beamer	BTX5L-BS				
848cc	2010-08	848	BT12B-4		2004-00	Beamer	BTX5L-BS				
	2013-11	848 EVO	BT12B-4		2010	Beamer 50	BTX5L-BS				
	2013-12	848 EVO Corse SE	BT12B-4		2005	Beamer II	BTX5L-BS				
	2013-12	Streelfighter 848	BT12B-4		2009-06	Beamer III	BTX5L-BS				
800cc	2004-03	800	BT12B-4		2005	Beamer Matrix	BTX5L-BS				
	2003	800 Sport	BT12B-4		2008-06	Beamer Matrix II	BTX5L-BS				
	2008-07	Desmosedici RR	BT12B-4		2008-07	Beamer R2	BTX5L-BS				
	2004	Monster 800	BT12B-4		2010-09	Matrix 50	BTX5L-BS				
	2003	Monster 800 Dark	BT12B-4		2010-09	Sport 50	BTX7A-BS				
	2003	Monster 800s	BT12B-4	<b>EXCELSIOR-HENDERSON</b>							
	2006-05	Monster S2R	BT12B-4	934cc	2000-99	Super X	BTX20L-BS				
	2007	Monster S2R 800	BT12B-4								
	2006-05	Monster S2R Dark	BT12B-4								
796cc	2012-10	Hypermotard 796	BT12B-4								

# POWERSPORT - Motorcycle & Scooter

ENGINE	YEAR	MODEL	JIS Battery Type	ENGINE	YEAR	MODEL	JIS Battery Type	ENGINE	YEAR	MODEL	JIS Battery Type
<b>HARLEY DAVIDSON (Cont.)</b>				<b>HARLEY DAVIDSON (Cont.)</b>				<b>HARLEY DAVIDSON (Cont.)</b>			
1690cc	2013-11	FLTRU Road Glide Ultra	BTX30L	1550cc	2004	FXSTDSE2 Screamin Eagle Softail Deuce 2	BTX20L	1340cc	1998	FLHRCI Road King Classic	BTX30L
	2013-12	FLTRX Road Glide Custom	BTX30L	1450cc	2006-99	FLHR Road King	BTX30L		1998-97	FLHT Electra Glide Standard	BTX30L
	2014-12	FXDF Fat Bob	BTX20L		2006-99	FLHRCI Road King Classic	BTX30L		1998-97	FLHTC Electra Glide Classic	BTX30L
	2014-12	FXDWG Dyna Wide Glide	BTX20L		2006-00	FLHRI Road King	BTX30L		1997	FLHTCU Electra Glide Ultra Classic	BTX30L
	2013-12	FXS Blackline	BTX20L		1997	FLHRI Road King	BTX30L		1998-97	FLSTC Heritage Softail Classic	BTX20L
	2014-13	FXSB Breakout	BTX20L		2006-04	FLHRS Road King Custom	BTX30L		1995	FLSTC Heritage Softail Classic	BTX20L-BS
1638cc	1998	FLTR Road Glide	BTX30L		2006-04	FLHRSI Road King Custom	BTX30L		1998-97	FLSTF Fat Boy	BTX20L
1584cc	2011-07	FLHR Road King	BTX30L		2006-99	FLHT Electra Glide Standard	BTX30L		1996-95	FLSTF Fat Boy	BTX20L-BS
	2010-07	FLHRC Road King Classic	BTX30L		2005-99	FLHTC Electra Glide Classic	BTX30L		1996-95	FLSTN Heritage Softail Special	BTX20L-BS
	2007	FLHRS Road King Custom	BTX30L		2006-97	FLHTCI Electra Glide Classic	BTX30L		1998-97	FLSTS Heritage Springer	BTX20L
	2008	FLHRSE4 Screamin Eagle Road King	BTX30L		2004	FLHTCSE Screamin Eagle Electra Glide	BTX30L		1999	FLTR Road Glide	BTX30L
	2009	FLHT Electra Glide Standard	BTX20L		2006-97	FLHTCUI Electra Glide Ultra Classic	BTX30L		1998	FLTRI Road Glide	BTX30L
	2008-07	FLHT Electra Glide Standard	BTX30L		2006-03	FLHTI Electra Glide Standard	BTX30L		1998-97	FXD Dyna Super Glide	BTX20L
	2011-07	FLHTC Electra Glide Classic	BTX30L		2006	FLHX Street Glide	BTX30L		1996-95	FXD Dyna Super Glide	BTX20L-BS
	2011-07	FLHTCU Electra Glide Ultra Classic	BTX30L		2006	FLHXI Street Glide	BTX30L		1998-97	FXDL Dyna Low Rider	BTX20L
	2009	FLHTCUSE4 CVO Ultra Classic Electra Glide	BTX30L		2006	FLHXI Street Glide	BTX30L		1996-95	FXDL Dyna Low Rider	BTX20L-BS
	2010	FLHTCUSE5 CVO Ultra Classic Electra Glide	BTX30L		2006-99	FLST Heritage Softail Classic	BTX20L		1998-97	FXDS-Conv Dyna Convertible	BTX20L
	2014	FLHTCUTG Tri Glide Ultra	BTX30L		2006-01	FLSTCI Heritage Softail Classic	BTX20L		1996-95	FXDS-Conv Dyna Convertible	BTX20L-BS
	2010-09	FLHTCUTG Tri Glide Ultra Classic	BTX30L		2006-99	FLSTF Fat Boy	BTX20L		1998-97	FXDWG Dyna Wide Glide	BTX20L
	2011-07	FLHX Street Glide	BTX30L		2006-01	FLSTFI Fat Boy	BTX20L		1996-95	FXDWG Dyna Wide Glide	BTX20L-BS
	2011-07	FLSTC Heritage Softail Classic	BTX20L		2006	FLSTI Heritage Softail	BTX20L		1999	FXR2	B16-B
	2011-07	FLSTF Fat Boy	BTX20L		2006-05	FLSTN Softail Deluxe	BTX20L		1999	FXR3	B16-B
	2011-10	FLSTFB Fat Boy Lo	BTX20L		2006-05	FLSTNI Softail Deluxe	BTX20L		1999	FXST Softail Standard	BTX20L
	2011-07	FLSTN Softail Deluxe	BTX20L		2003-99	FLSTS Heritage Springer	BTX20L		1999-97	FXSTB Night Train	BTX20L
	2011-08	FLSTSB Cross Bones	BTX20L		2006-05	FLSTSC Softail Springer Classic	BTX20L		1999-97	FXSTC Softail Custom	BTX20L
	2007	FLSTSC Softail Springer Classic	BTX20L		2006-05	FLSTSCI Softail Springer Classic	BTX20L		1996-95	FXSTC Softail Custom	BTX20L-BS
	2010	FLSTSE CVO Softail Convertible	BTX20L		2003-01	FLSTSI Heritage Springer	BTX20L		1999-97	FXSTS Springer Softail	BTX20L
	2009-07	FLTR Road Glide	BTX30L		2002-00	FLTR Road Glide	BTX30L		1996-95	FXSTS Springer Softail	BTX20L-BS
	2009	FLTRSE3 CVO Road Glide	BTX30L		2006-99	FLTRI Road Glide	BTX30L		1997	FXSTSB Bad Boy	BTX20L
	2011-10	FLTRX Road Glide Custom	BTX30L		2005-99	FXD Dyna Super Glide	BTX20L		1996-95	FXSTSB Bad Boy	BTX20L-BS
	2009-08	FXCW Rocker	BTX20L		2006	FXDBI Street Bob	BTX20L		2006	VRXSE Screamin Eagle Destroyer	BTX20L-BS
	2011-08	FXCWC Rocker C	BTX20L		2005	FXDC Super Glide Custom	BTX20L		2010-08	VRSCAW V-Rod	BTX20L
	2010-07	FXD Dyna Super Glide	BTX20L		2006-05	FXDCI Super Glide Custom	BTX20L		2008	VRSCD Night Rod	BTX20L
	2014-07	FXDB Street Bob	BTX20L		2006-04	FXDI Dyna Super Glide	BTX20L		2014-08	VRSCDX Night Rod Special	BTX20L
	2014-07	FXDC Super Glide Custom	BTX20L		2006	FXDI35 Dyna 35th Anniversary Super Glide	BTX20L		2014-09	VRSCF V-Rod Muscle	BTX20L
	2011-08	FXDF Fat Bob	BTX20L		2005-99	FXDL Dyna Low Rider	BTX20L		2005	VRSCSE Screamin Eagle V-Rod	BTX20L
	2010	FXDFSE2 CVO Dyna Fat Bob	BTX20L		2006	FXDLI Dyna Low Rider	BTX20L		2006	VRSCSE2 Screamin Eagle V-Rod 2	BTX20L
	2009-07	FXDL Dyna Low Rider	BTX20L		2000-99	FXDS-Conv Dyna Convertible	BTX20L		2007	VRSCX V-Rod	BTX20L
	2005-04	FXDLI Dyna Low Rider	BTX20L		2005-99	FXDWG Dyna Wide Glide	BTX20L		2014-04	XL1200C Sportster 1200 Custom	BTX14L-BS
	2011-10	FXDWG Dyna Wide Glide	BTX20L		2001	FXDWG2	BTX20L		2003-97	XL1200C Sportster 1200 Custom	BTX20L
	2008-07	FXDWG Dyna Wide Glide	BTX20L		2002	FXDWG3	BTX20L		1996	XL1200C Sportster 1200 Custom	B16-B
	2011	FXS Blackline	BTX20L		2006-04	FXDWGI Dyna Wide Glide	BTX20L		2011-06	XL1200L Sportster 1200 Low	BTX14L-BS
	2007	FXST Softail Standard	BTX20L		2005-99	FXDX Dyna Super Glide Sport	BTX20L		2012-07	XL1200N Sportster 1200 Nightster	BTX14L-BS
	2009-07	FXSTB Night Train	BTX20L		2003-01	FXDXT Dyna Super Glide T-Sport	BTX20L		2008-04	XL1200R Sportster 1200 Roadster	BTX14L-BS
	2010-07	FXSTC Softail Custom	BTX20L		2000	FXR4	BTX20L-BS		2003-97	XL1200S Sportster 1200 Sport	BTX20L
	2007	FXSTD Softail Deuce	BTX20L		2006-00	FXST Softail Standard	BTX20L		1996	XL1200S Sportster 1200 Sport	B16-B
	2009	FXSTSSE3 CVO Softail Springer	BTX20L		2006-00	FXSTB Night Train	BTX20L		2014-12	XL1200V Seventy-Two	BTX14L-BS
1550cc	2002	FLHRSEI Screamin Eagle Road King	BTX30L		2006-01	FXSTBI Night Train	BTX20L		2014-10	XL1200X Forty-Eight	BTX14L-BS
	2000	FLTRSEI Screamin Eagle Road Glide	BTX30L		2006-01	FXSTDI Softail Deuce	BTX20L		2007	XL50 50th Anniversary Sportster	BTX14L-BS
	2001	FLTRSEI2 Screamin Eagle Road Glide 2	BTX30L		2006-01	FXSTI Softail Standard	BTX20L		2003-97	XLH1200	BTX20L
	2003	FXSTDSE Screamin Eagle Softail Deuce	BTX20L		2006-00	FXSTS Springer Softail	BTX20L				
					2006-01	FXSTSI Springer Softail	BTX20L				
				1340cc	1998-97	FLHR Road King	BTX30L				

# POWERSPORT - Motorcycle & Scooter

ENGINE	YEAR	MODEL	JIS Battery Type	ENGINE	YEAR	MODEL	JIS Battery Type	ENGINE	YEAR	MODEL	JIS Battery Type
<b>HARLEY DAVIDSON (Cont.)</b>				<b>HONDA (Cont.)</b>				<b>HONDA (Cont.)</b>			
1200cc	1996-95	XLH1200 .....	B16-B	1800cc	2005-04	NRX1800 Rune .....	BTX20L-BS	954cc	2003-02	CBR954RR .....	BTZ10S
	2010-09	XR1200 .....	BTX14L-BS		2008-02	VTX1800C .....	BTX20L-BS	929cc	2001-00	CBR929RR .....	BTZ10S
	2012-11	XR1200X .....	BTX14L-BS		2008-05	VTX1800F .....	BTX20L-BS	919cc	2007-02	CB900F 919 .....	BTZ10S
1130cc	2006-02	VRSCA V-Rod .....	BTX20L		2009-04	VTX1800N .....	BTX20L-BS	900cc	1999-95	CBR900RR .....	BTX9-BS
	2007	VRSCAW V-Rod .....	BTX20L		2008-02	VTX1800R .....	BTX20L-BS	800cc	1998-95	PC800 Pacific Coast .....	BTX12-BS
	2005-04	VRSCB V-Rod .....	BTX20L		2006-02	VTX1800S .....	BTX20L-BS		2009-02	VFR800 Interceptor .....	BTZ12S
	2007-06	VRSCD Night Rod .....	BTX20L		2008-07	VTX1800T .....	BTX20L-BS		2001-98	VFR800 Interceptor .....	BTX12-BS
	2007	VRSCDX Night Rod Special .....	BTX20L	1500cc	2000-95	GL1500A Gold Wing Aspencade .....	B50-N18L-A3		2009-02	VFR800A Interceptor .....	BTZ12S
	2007	VRSCR Street Rod .....	BTX14		2003-97	GL1500C/CD Valkyrie .....	BTX14-BS	750cc	2003-95	CB750 Nighthawk .....	B14-A2
	2006	VRSCR Street Rod .....	BTX20L		2001-99	GL1500CF Valkyrie Interstate .....	BTX14-BS		2003-95	VF750C Magna .....	BTX12-BS
883cc	2008-04	XL883 Sportster .....	BTX14L-BS		2000-97	GL1500CT Valkyrie Tour .....	BTX14-BS		1996-95	VF750CD Magna Deluxe .....	BTX12-BS
	2009-04	XL883C Sportster 883 Custom .....	BTX14L-BS		1996-95	GL1500I Gold Wing Interstate .....	B50-N18L-A3		1997-95	VFR750F Interceptor .....	BTX12-BS
	2003-99	XL883C Sportster 883 Custom .....	BTX20L		2000-95	GL1500SE Gold Wing Special Edition .....	B50-N18L-A3		2014-11	VT750C Shadow Aero .....	BTZ14S
	2010-05	XL883L Sportster 883 Low .....	BTX14L-BS		2000-95	GL1500SE Gold Wing Special Edition .....	B50-N18L-A3		2009-04	VT750C Shadow Aero .....	BTZ12S
	2014-11	XL883L SuperLow .....	BTX14L-BS	1300cc	2010-03	ST1300 .....	BTZ14S		2003-98	VT750C/CD Shadow ACE .....	BTX14-BS
	2014-09	XL883N Iron 883 .....	BTX14L-BS		2012	ST1300 ABS .....	BTZ14S		2014-12	VT750C2 Shadow Spirit .....	BTZ14S
	2007-05	XL883R Sportster 883 Roadster .....	BTX14L-BS		2010-03	ST1300 ABS .....	BTZ14S		2009-07	VT750C2 Shadow Spirit .....	BTZ12S
	2003-02	XL883R Sportster 883 Roadster .....	BTX20L		2014-10	VT1300CR Stalentine .....	BTZ14S		2014-13	VT750C2 Shadow Spirit ABS .....	BTZ14S
	2003-97	XLH883 .....	BTX20L		2014-12	VT1300CRA Stalentine ABS .....	BTZ14S		2014-10	VT750C2B Shadow Phantom .....	BTZ14S
	1996-95	XLH883 .....	B16-B		2010	VT1300CRA Stalentine ABS .....	BTZ14S		2014-13	VT750CA Shadow Aero ABS .....	BTZ14S
	1995	XLH883DLX Sportster 883 Deluxe .....	B16-B		2014-10	VT1300CS Sabre .....	BTZ14S		2007-05	VT750DC Shadow Spirit .....	BTZ14S
	2003-97	XLH883HUG Sportster 883 Hugger .....	BTX20L		2014-12	VT1300CSA Sabre ABS .....	BTZ14S		2003-01	VT750DC Shadow Spirit .....	BTZ14S
	1996-95	XLH883HUG Sportster 883 Hugger .....	B16-B		2010	VT1300CSA Sabre ABS .....	BTZ14S	700cc	2013-10	VT750RS Shadow RS .....	BTZ14S
<b>HM</b>					2014-10	VT1300CT Interstate .....	BTZ14S		2014	CTX700 .....	BTZ12S
50cc	2007-95	CRE 50 .....	BTX4L-BS		2014-11	VT1300CTA Interstate ABS .....	BTZ14S		2014	CTX700 DCT ABS .....	BTZ12S
<b>HONDA</b>					2014-10	VT13CX Fury .....	BTZ14S		2014	CTX700N DCT ABS .....	BTZ12S
1800cc	2005-01	GL1800 Gold Wing .....	BTX20L-BS		2014-10	VT13CXA Fury ABS .....	BTZ14S		2013-12	NC700X .....	BTZ12S
	2013-12	GL1800 Gold Wing Airbag .....	BTX20L		2009-04	VTX1300C .....	BTX14-BS		2013-12	NC700X DCT ABS .....	BTZ12S
	2010-09	GL1800 Gold Wing Airbag .....	BTX20L		2009-05	VTX1300R .....	BTX14-BS		2009	NSA700 DN-01 .....	BTZ14S
	2008-07	GL1800 Gold Wing Airbag .....	BTX20L-BS	1200cc	2007-03	VTX1300S .....	BTX14-BS		2010	NT700V .....	BTZ14S
	2012	GL1800A Gold Wing ABS .....	BTX20L		2009-08	VTX1300T .....	BTX14-BS	650cc	2011-10	NT700VA ABS .....	BTZ14S
	2010	GL1800A Gold Wing ABS .....	BTX20L		2013-12	VFR1200F .....	BTZ14S		2014-12	XR650L .....	BTX9-BS
	2005-01	GL1800A Gold Wing ABS .....	BTX20L-BS		2010	VFR1200F DCT .....	BTZ14S	600cc	2009-95	XR650L .....	BTX9-BS
	2013	GL1800B Gold Wing F6B .....	BTX20L	1100cc	2013-12	VFR1200F DCT .....	BTZ14S		2007-06	CB600F 599 .....	BTX7L-BS
	2013	GL1800B2 Gold Wing F6B Deluxe .....	BTX20L		2010	VFR1200F DCT .....	BTZ14S		2004	CB600F 599 .....	BTX7L-BS
	2013-12	GL1800HP Gold Wing Audio/Comfort .....	BTX20L		2013	CB1100 .....	BTZ14S		2012-10	CBF600SA .....	BTZ10S
	2010-09	GL1800HP Gold Wing Audio/Comfort .....	BTX20L		2013	CB1100 ABS .....	BTZ14S		1998-95	CBR600F F3 .....	BTX9-BS
	2006	GL1800HP Gold Wing Audio/Comfort .....	BTX20L-BS		2003-01	CBR1100XX Super Blackbird .....	BTZ12S		2000-99	CBR600F F4 .....	BTX9-BS
	2010-09	GL1800HPN Gold Wing Audio/Comfort/Navii .....	BTX20L		2000-97	CBR1100XX Super Blackbird .....	BTX12-BS		2006-01	CBR600F F4i .....	BTZ10S
	2008-06	GL1800HPN Gold Wing Audio/Comfort/Navii .....	BTX20L-BS		2003-95	ST1100 .....	BTX14-BS		2013-03	CBR600RR .....	BTZ10S
	2012	GL1800HPNA Gold Wing Audio/Comfort/Navii/ABS .....	BTX20L		2003-95	ST1100 ABS .....	BTX14-BS		2013-09	CBR600RR ABS .....	BTZ10S
	2010-09	GL1800HPNA Gold Wing Audio/Comfort/Navii/ABS .....	BTX20L		1996-95	VT1100C Shadow .....	B16A-AB		2010-02	FSC600 Silver Wing ABS .....	BTZ12S
	2008-06	GL1800HPNA Gold Wing Audio/Comfort/Navii/ABS .....	BTX20L-BS		2007-01	VT1100C Shadow Spirit .....	BTX14-BS		2013-03	FSC600A Silver Wing ABS .....	BTZ12S
	2013-12	GL1800HPNM Gold Wing Audio/Comfort/Navii/XM .....	BTX20L		2000-97	VT1100C Shadow Spirit .....	B16A-AB		2007-04	VT600C Shadow VLX .....	BTZ10S
	2013-12	GL1800HPNM Gold Wing Audio/Comfort/Navii/XM/ABS .....	BTX20L		1999-95	VT1100C2 Shadow ACE .....	B16A-AB		2003-95	VT600C Shadow VLX Deluxe .....	BTZ10S
	2008-06	GL1800P Gold Wing Premium Audio .....	BTX20L-BS		2007-00	VT1100C2 Shadow Sabre .....	BTX14-BS	500cc	2003-95	VT600CD Shadow VLX Deluxe .....	BTX9-BS
					2002-01	VT1100C3 Shadow Aero .....	BTX14-BS		2013	CB500F .....	BTZ10S
					2000-98	VT1100C3 Shadow Aero .....	B16A-AB		2013	CB500F ABS .....	BTZ10S
					2001	VT1100T Shadow ACE Tour .....	BTX14-BS		2013	CB500X .....	BTZ10S
					2000-98	VT1100T Shadow ACE Tour .....	B16A-AB		2013	CB500X ABS .....	BTZ10S
					1995	CB1000 .....	BTX12-BS	450cc	2013	CBR500R .....	BTZ10S
					2013-11	CB1000R .....	BTZ10S		2013	CBR500R ABS .....	BTZ10S
					2010-08	CBF1000A .....	BTZ7S		2014-12	CRF450X .....	BTZ7S
					2007-06	CBF1000A .....	BTZ10S	300cc	2009-05	CRF450X .....	BTZ7S
					1996-95	CBR1000F .....	B14L-B2		2014	NSS300 Forza .....	BTZ12S
					2013-08	CBR1000RR .....	BTZ7S		2014	NSS300A Forza ABS .....	BTZ12S
					2007-04	CBR1000RR .....	BTZ10S	250cc	2008-95	CB250 Nighthawk .....	BTX7L-BS
					2013-09	CBR1000RR ABS .....	BTZ7S		2013-11	CBR250R .....	BTX7L-BS
					2006-00	RVT1000R RC51 .....	BTZ12S		2013-11	CBR250R ABS .....	BTX7L-BS
					2005-01	VTR1000 Super Hawk .....	BTZ12S		2014-12	CMX250C Rebel .....	BTX7L-BS
					2000-98	VTR1000 Super Hawk .....	BTX12-BS		2009-96	CMX250C Rebel .....	BTX7L-BS
									2007-04	CN250 Helix .....	BTX12-BS
									2001-95	CN250 Helix .....	BTX12-BS
									1996-95	CR250R .....	BTX4L-BS
									2014-13	CRF250L .....	BTX7L-BS
									2013-12	CRF250X .....	BTX5L-BS

# POWERSPORT - Motorcycle & Scooter

ENGINE	YEAR	MODEL	JIS Battery Type	ENGINE	YEAR	MODEL	JIS Battery Type	ENGINE	YEAR	MODEL	JIS Battery Type
<b>HONDA (Cont.)</b>				<b>HUSABERG (Cont.)</b>				<b>INDIAN (Cont.)</b>			
250cc	2009-04	CRF250X .....	BTX5L-BS	400cc	1999-97	FC400 (Electric Start) .....	BTX9-BS	1720cc	2013-12	Chief Classic .....	BTX24HL-BS
	2004-01	NSS 250 Jazz .....	BTZ12S		1996	FE400 .....	BTX9-BS		2011-10	Chief Classic .....	BTX20H-BS
	2007-01	NSS250 Reflex .....	BTZ12S		2000-97	FE400 (Electric Start) .....	BTX9-BS		2013-12	Chief Dark Horse .....	BTX24HL-BS
	2007-01	NSS250A Reflex ABS .....	BTZ12S		2003	FE400E .....	BTX5L-BS		2011-10	Chief Dark Horse .....	BTX20H-BS
	2007-04	NSS250AS Reflex Sport ABS .....	BTZ12S		1996	FE400E .....	BTX9-BS		2009	Chief Deluxe .....	BTX20H-BS
	2007-04	NSS250S Reflex Sport .....	BTZ12S		2002-01	FE400E (Electric Start) .....	BTX5L-BS		2011-09	Chief Roadmaster .....	BTX20H-BS
	2006-05	PS250 Big Ruckus .....	BTZ12S		2000-97	FE400E (Electric Start) .....	BTX9-BS		2009	Chief Standard .....	BTX20H-BS
	1996-95	XR250L .....	BTX4L-BS		2003	FS400E .....	BTX5L-BS		2013-12	Chief Vintage .....	BTX24HL-BS
	1996-95	XR250R .....	BTX4L-BS	390cc	2012-10	FE390 .....	BTZ7S		2011-09	Chief Vintage .....	BTX20H-BS
230cc	2014-12	CRF230F .....	BTX5L-BS	350cc	1996	FC350 .....	BTX5L-BS		2013	Chief Vintage FE .....	BTX24HL-BS
	2009-03	CRF230F .....	BTX5L-BS		2014-13	FE350 .....	BTX5L-BS		2013	Chief Vintage LE .....	BTX24HL-BS
	2009-08	CRF230L .....	BTZ7S		1996-95	FE350 .....	BTX5L-BS	1650cc	2001-99	Chief .....	BTX20-BS
	2009	CRF230M .....	BTZ7S		1996	FE350E .....	BTX5L-BS	1638cc	2003-02	Chief .....	BTX24HL-BS
150cc	2014-12	CRF150F .....	BTX5L-BS	300cc	2014-13	TE300 .....	BTX5L-BS	1450cc	2001	Scout .....	BTX20-BS
	2009-06	CRF150F .....	BTX5L-BS		2012-11	TE300 .....	BTZ7S		2001	Spirit .....	BTX20-BS
	2013	PCX150 .....	BTZ7S	250cc	2014-13	FE250 .....	BTX5L-BS	1442cc	2003-02	Scout .....	BTX20-BS
	2010	SH150i .....	BTX7L-BS		2014-13	TE250 .....	BTX5L-BS		2003-02	Spirit .....	BTX20-BS
125cc	2014	CRF125F .....	BTX4L-BS	125cc	2012-11	TE250 .....	BTZ7S	<b>KAWASAKI</b>			
	2014	CRF125FB Big Wheel .....	BTX4L-BS		2012	TE125 .....	BTX5L-BS	2000cc	2009-04	VN2000A Vulcan 2000 .....	BTX16-BS
	2014	Grom 125 .....	BTZ5S	<b>HUSQVARNA</b>					2006-05	VN2000D Vulcan 2000 Limited .....	BTX16-BS
	2011	PCX125 .....	BTZ7S	630cc	2011-10	SM 630 .....	BTX14-BS		2009-06	VN2000E Vulcan 2000 Classic .....	BTX16-BS
110cc	2014-13	CRF110F .....	BTX4L-BS		2005	SMR 630 .....	BTX14-BS		2010-06	VN2000F Vulcan 2000 Classic LT .....	BTX16-BS
	2010	NXH110 Elite .....	BTX7L-BS		2011	SMS 630 .....	BTX14-BS		2010-06	VN2000F Vulcan 2000 Classic LT .....	BTX16-BS
90cc	1996-95	EZ90 Cub .....	BTX5L-BS	610cc	2011-10	TE630 .....	BTX14-BS	1700cc	2012-09	VN1700 Vulcan 1700 Classic .....	BTX16-BS
80cc	2007-95	CH80 Elite .....	BTX5L-BS		2009	SM 610 .....	BTX14-BS		2010-09	VN1700 Vulcan 1700 Classic LT .....	BTX16-BS
50cc	2009-02	CHF50 Metropolitan .....	BTZ7S		2008-06	SMR 610 .....	BTX14-BS		2013-09	VN1700 Vulcan 1700 Nomad .....	BTX16-BS
	2005-02	CHF50P Metropolitan II .....	BTZ7S		2009-98	TE610 .....	BTX14-BS		2014	VN1700 Vulcan 1700 Nomad ABS .....	BTX16-BS
	2013	NCH50 Metropolitan .....	BTX4L-BS	570cc	2002	SMR 570 .....	BTZ7S		2013-11	VN1700 Vulcan 1700 Vaquero .....	BTX16-BS
	2013-11	NPS50 Ruckus .....	BTZ7S		2002-01	TE570 .....	BTZ7S		2014	VN1700 Vulcan 1700 Vaquero ABS .....	BTX16-BS
	2009-03	NPS50 Ruckus .....	BTZ7S	511cc	2011	TE511 .....	BTZ7S		2014	VN1700 Vulcan 1700 Voyager .....	BTX16-BS
	2009-04	NPS50S Ruckus .....	BTZ7S	510cc	2009	SM 510RR .....	BTZ7S		2012-09	VN1700 Vulcan 1700 Voyager ABS .....	BTX16-BS
	2001-95	SA50 Elite SR .....	BTX4L-BS		2009-05	SMR 510 .....	BTZ7S		2012-09	VN1700 Vulcan 1700 Voyager ABS .....	BTX16-BS
	2001-95	SA50P Elite S .....	BTX4L-BS		2009-04	TC510 .....	BTZ7S		2014	VN1700 Vulcan 1700 Voyager ABS .....	BTX16-BS
<b>HUSABERG</b>					2010-02	TE510 .....	BTZ7S		2014	VN1700 Vulcan 1700 Voyager ABS .....	BTX16-BS
650cc	2008-03	FE650E .....	BTZ7S		2010-08	TXC 510 .....	BTZ7S		2014	VN1700 Vulcan 1700 Voyager ABS SE .....	BTX16-BS
	2002-01	FE650E (Electric Start) .....	BTX5L-BS	450cc	2009	SM 450RR .....	BTZ7S		2012-09	VN1700 Vulcan 1700 Voyager .....	BTX16-BS
	2008-05	FS650C .....	BTZ7S		2010-05	SMR 450 .....	BTZ7S		2014	VN1700 Vulcan 1700 Voyager ABS .....	BTX16-BS
	2008-03	FS650E .....	BTZ7S		2011-02	TC450 .....	BTZ7S		2012-09	VN1700 Vulcan 1700 Voyager .....	BTX16-BS
	2002	FS650E (Electric Start) .....	BTX5L-BS		2011-02	TE450 .....	BTZ7S		2014	VN1700 Vulcan 1700 Voyager ABS .....	BTX16-BS
	2003	FX650E .....	BTZ7S		2010-08	TXC 450 .....	BTZ7S		2012-09	VN1700 Vulcan 1700 Voyager ABS .....	BTX16-BS
	2002-01	FX650E (Electric Start) .....	BTX5L-BS	449cc	2011	TE449 .....	BTZ7S		2012-09	VN1700 Vulcan 1700 Voyager ABS .....	BTX16-BS
600cc	1996-95	FC600 .....	BTX5L-BS	410cc	2001-00	TE410 .....	BTX14-BS		2012-09	VN1700 Vulcan 1700 Voyager ABS .....	BTX16-BS
	2000-98	FC600 (Electric Start) .....	BTX9-BS	400cc	2001	TE400 .....	BTX14-BS		2012-09	VN1700 Vulcan 1700 Voyager ABS .....	BTX16-BS
	1996-95	FE600 .....	BTX9-BS	310cc	2012	TC310 .....	BTZ7S	1600cc	2008-03	VN1600A Vulcan 1600 Classic .....	BTX16-BS
	2000	FE600 (Electric Start) .....	BTX9-BS		2011-09	TE310 .....	BTZ7S		2008-04	VN1600B Vulcan 1600 Mean Streak .....	BTX16-BS
	1996	FE600E .....	BTX9-BS	250cc	2011-02	TC250 .....	BTZ7S		2008-05	VN1600D Vulcan 1600 Nomad .....	BTX16-BS
	2000-97	FE600E (Electric Start) .....	BTX9-BS		2012-02	TE250 .....	BTZ7S		1999-96	VN1500A Vulcan 1500 .....	B50-N18L-A3
	1999-98	FS600E (Electric Start) .....	BTX9-BS	<b>HYOSUNG</b>					1995	VN1500A Vulcan 88 .....	B50-N18L-A3
	2000-97	FX600E (Electric Start) .....	BTX9-BS	700cc	2011	ST7 .....	BT14B-4		1997-96	VN1500C Vulcan L .....	B50-N18L-A3
570cc	2012-09	FE570 .....	BTZ7S	650cc	2013-07	GT650 .....	BTX14-BS		2008-96	VN1500E Vulcan 1500 Classic .....	BTX16-BS
	2011	FS570 .....	BTZ7S		2013-05	GT650R .....	BTX14-BS		2001-99	VN1500G Vulcan 1500 Nomad .....	BTX16-BS
550cc	2005-04	FC550 .....	BTZ7S		2008-05	GT650S .....	BTX14-BS		2005-99	VN1500J/R Vulcan 1500 Drifter .....	BTX16-BS
	2002-01	FC550 (Electric Start) .....	BTX5L-BS		2011-09	GV650 .....	BT14B-4		2004-00	VN1500L Vulcan Nomad FI .....	BTX16-BS
	2008-04	FE550E .....	BTZ7S		2008-06	GV650 .....	BTX14-BS		2002-00	VN1500N Vulcan 1500 Classic FI .....	BTX16-BS
501cc	1996-95	FC501 .....	BTX5L-BS		2013-12	GV650 Aquila Pro .....	BT14B-4		2003-02	VN1500P Vulcan 1500 Mean Streak .....	BTX16-BS
	2000-97	FC501 (Electric Start) .....	BTX9-BS	250cc	2013-07	GT250 .....	BTX14-BS		2010-08	ZG1400 Concours .....	BTX14-BS
	2014-13	FE501 .....	BTX5L-BS		2013-07	GT250R .....	BTX14-BS		2014-08	ZG1400 Concours ABS .....	BTX14-BS
	1996-95	FE501 .....	BTX5L-BS		2011-05	GV250 .....	BTX9-BS		2011-06	ZX1400 Ninja ZX-14 .....	BTX14-BS
	2000-97	FE501 (Electric Start) .....	BTX9-BS		2013-12	GV250 Aquila .....	BTX9-BS		2014-12	ZX1400 Ninja ZX-14R .....	BTX14-BS
	2003	FE501E .....	BTZ7S		2009-08	MS3-250 .....	BTX9-BS		2014-13	ZX1400 Ninja ZX-14R ABS .....	BTX14-BS
	1996	FE501E .....	BTX9-BS	50cc	2009-08	SD50/Sense .....	BTX4L-BS		2003-95	ZG1200 Voyager XII .....	B50N-18L-AT
	2002-01	FE501E (Electric Start) .....	BTX5L-BS		2009-08	SF50B/Prima .....	BTX4L-BS		2005-01	ZRX1200 .....	BTX14-BS
	2000-97	FE501E (Electric Start) .....	BTX9-BS	<b>INDIAN</b>							
	1998-97	FX501E (Electric Start) .....	BTX9-BS	1819cc	2014	Chief Classic .....	BTX20HL-BS				
470cc	2002-01	FC470 (Electric Start) .....	BTX5L-BS		2014	Chief Vintage .....	BTX20HL-BS				
	2002	FC470E (Electric Start) .....	BTX5L-BS		2014	Chieftain .....	BTX20HL-BS				
	2002-01	FX470E (Electric Start) .....	BTX5L-BS	1720cc	2011	Chief Blackhawk .....	BTX20H-BS				
450cc	2005-04	FC450 .....	BTZ7S		2011	Chief Blackhawk Dark .....	BTX20H-BS				
	2014-13	FE450 .....	BTX5L-BS		2010	Chief Bomber .....	BTX20H-BS				
	2012-09	FE450 .....	BTZ7S								
	2008-04	FE450E .....	BTZ7S								
	2008-04	FS450E .....	BTZ7S								
	2011-10	FX450 .....	BTZ7S								
400cc	1996	FC400 .....	BTX9-BS								

# POWERSPORT - Motorcycle & Scooter

ENGINE	YEAR	MODEL	JIS Battery Type	ENGINE	YEAR	MODEL	JIS Battery Type	ENGINE	YEAR	MODEL	JIS Battery Type
<b>KAWASAKI (Cont.)</b>				<b>KAWASAKI (Cont.)</b>				<b>KTM (Cont.)</b>			
1200cc	2005-00	ZX1200 Ninja ZX-12R	BTX14-BS	400cc	2003	KLX400SR	BT7B-4	400cc	2006-05	400 EXC	BTX5L-BS
	2005-02	ZZR1200	BTX14-BS	300cc	2014-13	EX300 Ninja 300	BTX9-BS	2004-03	400 EXC	BTZ5S	
1100cc	1995	ZR1100	BTX16-BS		2014-13	EX300 Ninja 300 ABS	BTX9-BS	2001-98	400 LC4	BTX9-BS	
	2000-99	ZRX1100	BTX14-BS		2014	EX300 Ninja 300 ABS SE	BTX9-BS	1998-97	400 LSE	BTX9-BS	
	1997-95	ZX1100 GPZ	BTX14-BS		2014	EX300 Ninja 300 SE	BTX9-BS	1998-96	400 RXC	BTX9-BS	
1000cc	2001-95	ZX1100 Ninja ZX-11	BTX14-BS	250cc	2012-09	EX250F Ninja 250R	BTX9-BS	2010-09	400 XC-W	BTX5L-BS	
	2005	KZ1000C/P Police	BTX20L-BS		2008	EX250F Ninja 250R	BTX7A-BS	2007	400 XC-W	BTX5L-BS	
	2003-02	KZ1000C/P Police	BTX20L-BS		2007-95	EX250F Ninja 250R	BTX7L-BS	2014-12	350 EXC-F	BTX4L-BS	
	2001-95	KZ1000C/P Police	B18L-A		2010-09	KL250 Super Sherpa	BTX7L-BS	2014-11	350 SX-F	BTX4L-BS	
	2013-10	Z1000	BTX9-BS		2003-00	KL250 Super Sherpa	BTX7L-BS	2014-12	350 XCF-W	BTX4L-BS	
	2008-03	Z1000	BTX9-BS		2005-95	KLR250	B4L-A	2014	300 XC	BTX5L-BS	
	2006-95	ZG1000 Concours	B18L-A		2014-12	KLX250S	BTX7L-BS	2013-06	300 XC	BTX4L-BS	
	2013-11	ZX1000 Ninja 1000	BTX9-BS		2010-09	KLX250S	BTX7L-BS	2014	300 XC-W	BTX5L-BS	
	2014	ZX1000 Ninja 1000 ABS	BT12A-BS		2007-06	KLX250S	BTX7L-BS	2013-06	300 XC-W	BTX4L-BS	
	2013-12	ZX1000 Ninja 1000 ABS	BTX9-BS	140cc	2010-09	KLX250SF	BTX7L-BS	2005-03	250 EXC	BTZ5S	
	2014-11	ZX1000 Ninja ZX-10R	BTZ7S		2014-11	KLX140	BTX7L-BS	2005	250 EXC	BTX5L-BS	
	2010-04	ZX1000 Ninja ZX-10R	BT12B-BS		2009-08	KLX140	BTX7L-BS	2002-95	250 EXC	BTX5L-BS	
	2014-11	ZX1000 Ninja ZX-10R ABS	BTZ10S		2014-11	KLX140L	BTX7L-BS	2005-03	250 EXC 4-Stroke	BTZ5S	
900cc	2014-06	VN900B Vulcan 900 Classic	BTX12-BS	125cc	2009-01	BN125 Eliminator	B9-B	2014-12	250 SX-F	BTX4L-BS	
	2014-07	VN900C Vulcan 900 Custom	BTX12-BS	110cc	2014-10	KLX110	BTX4L-BS	2014	250 XC	BTX4L-BS	
	2014-06	VN900D Vulcan 900 Classic LT	BTX12-BS	100cc	2014-10	KLX110L	BTX4L-BS	2013-06	250 XC-F	BTX5L-BS	
	2003-98	ZX900 Ninja ZX-9R	BTX9-BS		2001-95	KE100	6N6-1D-2	2009-07	250 XC-F	BTX5L-BS	
	1997-95	ZX900 Ninja ZX-9R	BTX12-BS	<b>KTM</b>				2014-12	250 XCF-W	BTX4L-BS	
800cc	2005-04	VN800A Vulcan 800	BTX12-BS	1190cc	2011-08	1190 RC8	BTZ14S	2011-06	250 XCF-W	BTX5L-BS	
	2003-95	VN800A Vulcan 800	BTX14-BS		2013-10	1190 RC8 R	BTZ14S	2014	250 XC-W	BTX5L-BS	
	2005-04	VN800B Vulcan 800 Classic	BTX12-BS		2012	1190 RC8 R Race	BTZ14S	2013-06	250 XC-W	BTX4L-BS	
	2003-96	VN800B Vulcan 800 Classic	BTX14-BS	990cc	2012-06	990 Adventure	BTZ14S	<b>KYMCO</b>			
	2006-04	VN800E Vulcan 800 Drifter	BTX12-BS		2011	990 Adventure Dakar Edition	BTZ14S	500cc	2012-09	Xciting 500Ri	BTX14-BS
	2003-00	VN800E Vulcan 800 Drifter	BTX14-BS		2012-09	990 Adventure R	BTZ14S	2014-09	Xciting 500Ri ABS	BTX14-BS	
750cc	2006-95	VN750A Vulcan 750	B14L-A2		2008-06	990 Adventure S	BTZ14S	300cc	2014-12	People GT 300i	BT12A-BS
	2005-04	Z750	BTX9-BS		2012	990 SMT	BTZ14S	250cc	2009	Venox 250	BTX9-BS
	2006-05	Z750S	BTX9-BS		2011-05	990 Super Duke	BTZ14S	2011-10	Xciting 250	BTX12-BS	
	1995	ZX750 Ninja ZX-7	BTX12-BS		2011-07	990 Super Duke R	BTZ14S	2003-12	People GT 200i	BT12A-BS	
	2003-96	ZX750 Ninja ZX-7R	BTX12-BS		2011	990 Supermoto	BTZ14S	2010-06	People S 200	BTX7A-BS	
	1995	ZX750 Ninja ZX-7R	BTX9-BS		2011-08	990 Supermoto R	BTZ14S	2012-09	People 150	BTX7A-BS	
	1997-96	ZX750 Ninja ZX-7RR	BTX9-BS		2013	990 Supermoto T	BTZ14S	2014-09	Super 8 150	BTX7A-BS	
700cc	2000	ZR-7	BTX12-BS	950cc	2006-02	950 Adventure	BTZ14S	2014-06	Agility 125	BTX5L-BS	
	2003-01	ZR-7S	BTX12-BS		2006-04	950 Adventure S	BTZ14S	2009	People S 125	BTX7A-BS	
650cc	2010-09	ER-6N	BTX12-BS		2009-07	950 Super Enduro R	BTZ14S	2014-09	Agility 50	BTX7A-BS	
	2014-12	EX650 Ninja 650	BT12A-BS		2008-05	950 Supermoto	BTZ14S	2012-09	People 50	BTX5L-BS	
	2014-13	EX650 Ninja 650 ABS	BT12A-BS	690cc	2013	690 Duke	BTX9-BS	2009	People S 50	BTX7A-BS	
	2011-06	EX650 Ninja 650R	BTX12-BS		2011-08	690 Duke	BTZ10S	2010-08	Super 8 50	BTX7A-BS	
	2013-08	KLE650 Versys	BTX12-BS		2008	690 Enduro	BTZ10S	2014-11	Super 8 50 2T	BTX7A-BS	
	2014	KLE650 Versys ABS	BTX12-BS		2013-09	690 Enduro R	BTZ10S	2009	Super 9	BTX5L-BS	
	2014-95	KLR650	B14L-A2	640cc	2011-08	690 SMC	BTZ10S	<b>MOTO GUZZI</b>			
	1996-95	KLX650	BTX9-BS		2008-07	690 Supermoto	BTZ10S	1400cc	2013	California 1400 Custom	BTX20-BS
	1996-95	KLX650R	BTX9-BS		2008-98	640 Adventure	BTZ10S		2013	California 1400 Touring	BTX20-BS
	2001-00	W650	BTX14-BS		2006-99	640 Duke II	BTZ10S	1200cc	2008	Breva 1200 Sport	53030
636cc	2014-13	ZX636 Ninja ZX-6R	BTX9-BS		2002-99	640 Supermoto	BTX9-BS	2010-09	Griso 1200	53030	
	2006-03	ZX636 Ninja ZX-6R	BTX9-BS	625cc	2006-04	625 SMC	BTZ10S	2009-07	Norge 1200	53030	
	2014-13	ZX636 Ninja ZX-6R ABS	BTX9-BS		2004-03	625 SXC	BTZ10S	2011	Norge 1200 GT	53030	
600cc	1997-96	ZL600 Eliminator	B12A-A	620cc	1997-96	620 Duke	BTX9-BS	2011-09	Stelvio 1200	BTX20CH-BS	
	2002-95	ZX600 Ninja ZX-6	BTX12-BS	530cc	2011-08	530 EXC-R	BTX5L-BS	2013	Stelvio 1200 NTX	BTX20CH-BS	
	2012-07	ZX600 Ninja ZX-6R	BTX9-BS		2011-08	530 XC-W	BTX5L-BS	1150cc	2011	Griso 8V SE	53030
	2002-95	ZX600 Ninja ZX-6R	BTX12-BS	525cc	2006-05	525 EXC	BTX5L-BS	1100cc	1996	1100 California	53030
	2006-03	ZX600 Ninja ZX6-RR	BTX9-BS		2004-03	525 EXC	BTZ5S	1996-95	1100 California I	53030	
	2008-05	ZZR 600	BTX9-BS	500cc	2007-06	525 EXC-G	BTX5L-BS	1996-95	1100 Sport	53030	
	2004-03	ZZR 600	BTX12-BS		2002-00	520 EXC	BTX4L-BS	1995	1100 Sport I	53030	
500cc	1996-95	EN500 Vulcan 500	B12A-A	450cc	2014-12	500 EXC	BTX5L-BS	2008-07	Breva 1100	53030	
	2009-96	EN500C Vulcan 500 LTD	B12AL-A2		2012	500 EXC Six Days	BTX5L-BS	2008-07	Griso 1100	53030	
	1996	EN500C Vulcan 500 LTD	B12A-A		2014-12	500 XC-W	BTX5L-BS	2000-99	V11 Bassa	53030	
	1996-95	EX500 Ninja 500	B14L-A2		2005	450 EXC	BTX5L-BS	1999-98	V11 EV	53030	
	2009-97	EX500 Ninja 500R	B14L-A2		2004-03	450 EXC	BTZ5S	2000	V11 Jackal	53030	
450cc	2010-08	KLX450R	BTZ7S		2011-08	450 EXC-R	BTX5L-BS	2000-99	V11 Quota	53030	
400cc	2003	KLX400R	BT7B-4		2009-08	450 SMR	BTX5L-BS	2001-00	V11 Sport	53030	
					2014-11	450 SX-F	BTX4L-BS	2001	V11 Sport Rosso Mandello	53030	
					2010-03	450 SX-F	BTX5L-BS	2011	California Black Eagle	53030	
					2013-12	450 SX-F Factory Edition	BTX4L-BS	2005-01	California EV	53030	
					2014-13	450 XC-F	BTX5L-BS	2001	California Jackel	53030	
					2009-06	450 XC-F	BTX5L-BS	2001	California Special	53030	
					2014-06	450 XC-W	BTX5L-BS	2005-02	California Stone	53030	

# POWERSPORT - Motorcycle & Scooter

ENGINE	YEAR	MODEL	JIS Battery Type	ENGINE	YEAR	MODEL	JIS Battery Type	ENGINE	YEAR	MODEL	JIS Battery Type	
<b>MOTO GUZZI (Cont.)</b>				<b>SUZUKI (Cont.)</b>				<b>SUZUKI (Cont.)</b>				
1065cc	2003-02	California Stone Metal .....	53030	1800cc	2009-07	M109RZ		650cc	2012-11	AN650A Burgman		
	2005-04	California Stone Touring .....	53030			Boulevard Limited .....	BTX20CH-BS			Executive .....	BTX14	
	2010	California Vintage .....	BTX20L-BS	1600cc	2005	M95 Boulevard .....	BTX20CH-BS		2009-06	AN650A Burgman		
	2009-07	California Vintage .....	53030		2004	VZ1600 Marauder .....	BTZ16-BS			Executive .....	BTX14	
1000cc	1998	V10 Centauro GT .....	53030	1500cc	2013	C90 Boulevard .....	BTX16-BS-1		2009-04	DL650 V-Strom	BTX12-BS	
	1998	V10 Centauro Sport .....	53030		2009-05	C90 Boulevard .....	BTX16-BS-1		2013-11	DL650A V-Strom ABS ...	BTX12-BS	
750cc	2008-07	Breva 750 .....	BTX14AHL-BS		2013	C90 Boulevard			2009-07	DL650A V-Strom ABS ...	BTX12-BS	
	2008-07	Nevada Classic 750 .....	B18L-A			B.O.S.S. ....	BTX16-BS-1		2013-12	DL650A V-Strom ABS		
700cc	2011-09	V7 Classic .....	53030		2008-05	C90B Boulevard .....	BTX16-BS-1			Adventure .....	BTX12-BS	
	2011-09	V7 Classic .....	BTX14AHL-BS		2013	C90T Boulevard .....	BTX16-BS-1		2013-11	DR650SE .....	BTX9-BS	
<b>MV AGUSTA</b>					2009-05	C90T Boulevard .....	BTX16-BS-1		2009-06	DR650SE .....	BTX9-BS	
	2009-05	C90T Boulevard .....	BTX16-BS-1		2013	C90T Boulevard			1997-96	DR650SE .....	B10L-B2	
1090cc	2013	Brutale 1090 .....	BTZ10S			B.O.S.S. ....	BTX16-BS-1		1995	DR650SES .....	BTX12-BS	
	2013	Brutale 1090 ABS .....	BTZ10S		2013	M90 Boulevard .....	BTX20CH-BS		2009-08	GSX650F .....	BTX9-BS	
	2013-12	Brutale 1090R .....	BTZ10S		2009	M90 Boulevard .....	BTX20CH-BS		2008-05	LS650 Savage .....	B14L-B2	
	2013	Brutale 1090R ABS .....	BTZ10S		2004-98	VL1500 Intruder .....	BTX16-BS-1		2013-11	S40 Boulevard .....	B14L-B2	
	2013-10	Brutale 1090RR .....	BTZ10S	1400cc	2008-05	S83 Boulevard .....	BTX16-BS-1		2009-05	S40 Boulevard .....	B14L-B2	
	2013	Brutale 1090RR ABS .....	BTZ10S		2004-95	VS1400GL Intruder .....	BTX16-BS-1		2013	SFV650 .....	BTX12-BS	
1080cc	2013	Brutale Corsa .....	BTZ10S	1300cc	2008	GSX1300BK B-King .....	BTX12-BS		2009	SFV650 Gladius .....	BTX12A-BS	
1078cc	2009	Brutale 1078RR .....	BTZ10S		2013-11	GSX1300R Hayabusa ...	BTX12-BS		2008-03	SV650 .....	BTX12-BS	
	2009	F4 RR 312 1078 .....	BTZ10S		2009-08	GSX1300R Hayabusa ...	BTX12-BS		2002-99	SV650 .....	BT12A-BS	
1000cc	2013-10	F4 .....	BTZ10S		2007-99	GSX1300R Hayabusa ...	BT12A-BS		2008-07	SV650A ABS .....	BTX12-BS	
	2008	F4 R 312 .....	BTZ10S		2013-12	GSX1300R Hayabusa			2009-03	SV650S .....	BTX12-BS	
	2008	F4 R 312 1+1 .....	BTZ10S			Limited Edition .....	BTX12-BS		2002-99	SV650S .....	BT12A-BS	
	2006-05	F4-1000 S .....	BTZ10S		2006	GSX1300R Hayabusa			2009-07	SV650SA ABS .....	BTX12-BS	
	2006-05	F4-1000 S 1+1 .....	BTZ10S			Limited Edition .....	BT12A-BS		2003-96	GSF600S Bandit .....	BTX9-BS	
	2007	F4-1000R .....	BTZ10S	1250cc	2009-07	GSF1250S Bandit .....	BT12A-BS		2006-98	GSX600F Katana .....	BTX9-BS	
	2007	F4-1000R 1+1 .....	BTZ10S		2009-07	GSF1250SA Bandit			1997-95	GSX600F Katana .....	B10L-B2	
	2013	F4R .....	BTZ10S			ABS .....	BT12A-BS		2013-11	GSX-R600 .....	BTX9-BS	
	2013	F4R ABS .....	BTZ10S		2011	GSX1250FA .....	BT12A-BS		2009-97	GSX-R600 .....	BTX9-BS	
	2013	F4RR .....	BTZ10S	1200cc	2006-97	GSF1200S Bandit .....	BTX12-BS		1996-95	RF600 .....	BTX9-BS	
	2013	F4RR ABS .....	BTZ10S	1100cc	1998-95	GSX-R1100 .....	BTX12-BS		2002-95	GS500 .....	B10L-B2	
	2012	F4RR Corsacorta .....	BTZ10S	1000cc	2012	DL1000 V-Strom .....	BTX14-BS		2009-04	GS500F .....	B10L-B2	
990cc	2011-10	Brutale 990R .....	BTZ10S		2009-02	DL1000 V-Strom .....	BTX14-BS		2010	RMX450Z .....	BTZ7S	
910cc	2008-06	Brutale 910 R .....	BTZ10S		2012	DL1000 V-Strom			450cc	AN400 Burgman .....	BTX9-BS	
	2008	Brutale 910 S .....	BTZ10S			Adventure .....	BTX14-BS		400cc	AN400 Burgman ABS .....	BTX9-BS	
	2006	Brutale 910 S .....	BTZ10S		2013-11	GSX-R1000 .....	BT12A-BS		2013-11	AN400 Burgman ABS .....	BTX9-BS	
900cc	2004	Brutale ORO .....	BTZ10S		2009-05	GSX-R1000 .....	BT12A-BS		2009	AN400 Burgman ABS .....	BTX9-BS	
800cc	2013	Brutale 800 .....	BTZ10S		2004-01	GSX-R1000 .....	BTX12-BS		2006-03	AN400S Burgman		
	2013	Brutale 800 EAS .....	BTZ10S		2013	GSX-R1000 1 Million				Type S .....	BTX9-BS	
	2013	Brutale 800 ITALIA .....	BTZ10S			C.E. ....	BT12A-BS		2004-00	DR-Z400 .....	BT7B-BS	
	2013	F3 800 EAS .....	BTZ10S		2007-03	SV1000/S .....	BTX14-BS		2007-00	DR-Z400E .....	BT7B-BS	
	2013	Rivale 800 .....	BTZ10S		2003-98	TL1000R .....	BT12A-BS		2013-11	DR-Z400S .....	BT7B-BS	
750cc	2005-04	Brutale S .....	BTZ10S		2001-97	TL1000S .....	BTX12-BS		2009-00	DR-Z400S .....	BT7B-BS	
	2003	F4-750 S .....	BTZ10S	900cc	1997-95	RF900 .....	BTX9-BS		2013	DR-Z400SM .....	BT7B-BS	
	2003	F4-750 S 1+1 .....	BTZ10S	800cc	2013	C50 Boulevard .....	BTX12-BS		2009-05	DR-Z400SM .....	BT7B-BS	
	2002-00	F4-S .....	BTZ10S		2009-05	C50 Boulevard .....	BTX12-BS		1999-95	DR350SE .....	BTX7L-BS	
	2002-01	F4-S 1+1 .....	BTZ10S		2014	C50 Boulevard			1995	DR250SE .....	BTX7L-BS	
	2002	F4-S Senna .....	BTZ10S			B.O.S.S. ....	BTX12-BS		2007-01	DR-Z250 .....	BTZ7S	
	2004	F4-SPR .....	BTZ10S		2013	C50 Boulevard SE .....	BTX12-BS		2010-99	GZ250 .....	BTX7L-BS	
675cc	2013	Brutale 675 .....	BTZ10S		2009	C50 Boulevard SE .....	BTX12-BS		2011	TU250 .....	BTX7L-BS	
	2013	Brutale 675 EAS .....	BTZ10S		2008-05	C50B Boulevard .....	BTX12-BS		2013-12	TU250X .....	BTX7L-BS	
	2013-12	F3 675 .....	BTZ10S		2008-06	C50C Boulevard .....	BTX12-BS		2009	TU250X .....	BTX7L-BS	
	2013	F3 675 EAS .....	BTZ10S		2013-11	C50T Boulevard .....	BTX12-BS		2013	DR200SE .....	BTX7L-BS	
	2012	F3 Serie Oro .....	BTZ10S		2009-05	C50T Boulevard .....	BTX12-BS		2009-96	DR200SE .....	BTX7L-BS	
	2012	F4 .....	BTZ10S		2012	C50T Boulevard			1996-95	DR125SE .....	BTX7L-BS	
						Classic .....	BTX12-BS		1997-95	GN125E .....	B7-A	
<b>PIAGGIO</b>					2009-05	M50 Boulevard .....	BTX12-BS		70cc	2009-08	DR-Z70 .....	BT4B-5
500cc	2010-07	BV Tourer 500 .....	BTX14-BS		2007	M50 Boulevard Limited ..	BTX12-BS		<b>TM</b>			
	2013-08	MP3 500 .....	BTX14-BS		2009	M50 Boulevard SE .....	BTX12-BS		660cc	2009-08	SMX660F .....	BTX7L-BS
400cc	2013-08	MP3 400 .....	BTX14-BS		2006-05	M50B Boulevard .....	BTX12-BS			2006-04	SMX660F .....	BTX7L-BS
250cc	2010-08	BV Tourer 250 .....	BTX14-BS		2009-05	S50 Boulevard .....	B16B-A1		530cc	2009-05	EN530F .....	BTX7L-BS
	2013-07	MP3 250 .....	BTX14-BS		2004-01	VL800 Intruder Volusia ..	BTX12-BS			2009-05	MX530F .....	BTX7L-BS
150cc	2013-09	Fly 150 .....	B9-B		2004-95	VS800GL Intruder .....	B16B-A1		2009-04	SMM530F .....	BTX7L-BS	
50cc	2012-09	Fly 50 .....	B9-B		2004-97	VZ800 Marauder .....	BTX12-BS		2009-05	SMR530F .....	BTX7L-BS	
	2013	Fly 50 4V .....	B9-B	750cc	2006-98	GSX750F Katana .....	BTX9-BS		2007	SMX530F .....	BTX7L-BS	
					1997-95	GSX750F Katana .....	B14L-B2		2009-04	EN450F .....	BTX7L-BS	
					2013-11	GSX-R750 .....	BT12A-BS		2009-04	MX450F .....	BTX7L-BS	
					2009-00	GSX-R750 .....	BT12A-BS		2009-05	SMM450F .....	BTX7L-BS	
					2006-96	GSX-R750 .....	BTX9-BS		2009-04	SMR450F .....	BTX7L-BS	
					1995	GSX-R750 (MODEL			2009-04	SMX450F .....	BTX7L-BS	
						P) .....	BTX12-BS		2009-04	EN250 .....	BTX7L-BS	
					1995	GSX-R750 (MODEL R/			2009-04	EN250F .....	BTX7L-BS	
						S) .....	BTX9-BS		2009-05	MX250 .....	BTX7L-BS	
1800cc	2009-08	C109R Boulevard .....	BTX20CH-BS	650cc	2009-03	AN650 Burgman .....	BTX14		2009-05	MX250F .....	BTX7L-BS	
	2009-08	C109RT Boulevard ...	BTX20CH-BS		2013	AN650A Burgman ABS .....	BTX14		2003	XC250 .....	BTX7L-BS	
	2013-11	M109R Boulevard .....	BTX20CH-BS									
	2009-06	M109R Boulevard .....	BTX20CH-BS									
	2014	M109R Boulevard										
		B.O.S.S. ....	BTX20CH-BS									
	2009-08	M109R2 Boulevard ...	BTX20CH-BS									
	2013-12	M109RZ										
		Boulevard Limited .....	BTX20CH-BS									

# POWERSPORT - Motorcycle & Scooter

ENGINE	YEAR	MODEL	JIS Battery Type	ENGINE	YEAR	MODEL	JIS Battery Type	ENGINE	YEAR	MODEL	JIS Battery Type
<b>TRIUMPH</b>				<b>VESPA</b>				<b>VICTORY (Cont.)</b>			
2300cc	2010-04	Rocket III .....	BTX20L-BS	300cc	2013-10	GTS 300 .....	BTX14-BS	1500cc	2005	Vegas 8-Ball .....	BTX20L-BS
	2009-06	Rocket III Classic .....	BTX20L-BS		2013-09	GTS 300 Super .....	BTX14-BS	<b>YAMAHA</b>			
	2011-07	Rocket III Classic Tourer .....	BTX20L-BS		2013	GTS 300 Super Sport SE .....	BTX14-BS	1900cc	2007-06	XV1900 Roadliner .....	BT14B-4
	2013-11	Rocket III Roadster .....	BTX20L-BS		2013-11	GTV 300 .....	BTX14-BS		2009	XV1900CT Stratoliner .....	BT14B-4
	2013-12	Rocket III Touring .....	BTX20L-BS	250cc	2010	GTV 250 .....	BTX14-BS		2007-06	XV1900CT Stratoliner .....	BT14B-4
1700cc	2011-10	Thunderbird 1700 .....	BTX20L-BS	50cc	2013-10	LX 50 4V .....	B9-B		2014	XV1900CT Stratoliner Deluxe .....	BT14B-4
	2013	Thunderbird Storm .....	BTX20L-BS	<b>VICTORY</b>					2012-10	XV1900CT Stratoliner Deluxe .....	BT14B-4
	2013-12	Thunderbird Storm ABS .....	BTX20L-BS	1731cc	2014	15th Anniversary Cross Country Tour LE .....	BTX20HL-BS		2008-06	XV1900CTM Stratoliner Midnight .....	BT14B-4
1600cc	2013	Thunderbird .....	BTX20L-BS		2013-09	Arlen Ness Vision .....	BTX20HL-BS		2014-06	XV1900CTS Stratoliner S .....	BT14B-4
	2011-10	Thunderbird .....	BTX20L-BS		2014-13	Boardwalk .....	BTX20HL-BS		2009-06	XV1900M Roadliner Midnight .....	BT14B-4
	2013-10	Thunderbird ABS .....	BTX20L-BS		2012-11	Cory Ness Cross Country .....	BTX20HL-BS		2014-12	XV1900S Roadliner S .....	BT14B-4
	2011	Thunderbird SE .....	BTX20L-BS		2013	Cory Ness Cross Country Tour .....	BTX20HL-BS		2010-06	XV1900S Roadliner S .....	BT14B-4
	2011	Thunderbird Storm .....	BTX20L-BS		2010-09	Cory Ness Jackpot .....	BTX20HL-BS		2014-12	XV19C Raider SCL .....	BT14B-4
1200cc	1997-95	Daytona 1200 .....	B14L-A2		2014-10	Cross Country .....	BTX20HL-BS		2014-08	XV19CX Raider .....	BT14B-4
	2003-00	Trophy 1200 .....	BTX14-BS		2014	Cross Country 8- Ball .....	BTX20HL-BS	1700cc	2014-09	VMX1700 V-Max .....	BTZ14S
	1999-95	Trophy 1200 .....	B14L-A2		2010-09	Cory Ness Jackpot .....	BTX20HL-BS		2009-08	XV1700A Road Star .....	BT14B-4
	2012-05	Speed Triple .....	BTX12-BS		2014-10	Cross Country .....	BTX20HL-BS		2007-04	XV1700A Road Star .....	BTX20L-BS
1050cc	2013-11	Speed Triple ABS .....	BTX12-BS		2014	Cross Country 8- Ball .....	BTX20HL-BS		2007-04	XV1700AM Road Star Midnight .....	BTX20L-BS
	2013-12	Speed Triple R ABS .....	BTX12-BS		2014-12	Cross Country Tour .....	BTX20HL-BS		2014-08	XV1700AS Road Star S .....	BT14B-4
	2013	Speed Triple SE .....	BTX12-BS		2012-10	Cross Roads .....	BTX20HL-BS		2010-08	XV1700AT Road Star Silverado .....	BT14B-4
	2010-05	Sprint ST .....	BTX12-BS		2014	Cross Roads 8-Ball .....	BTX20HL-BS		2007-04	XV1700AT Road Star Silverado .....	BTX20L-BS
	2011-07	Tiger .....	BT12B-BS		2014-13	Cross Roads Classic .....	BTX20HL-BS		2007-04	XV1700ATM Road Star Midnight Silverado .....	BTX20L-BS
	2011-10	Tiger 1050 ABS .....	BT12B-BS		2012	Cross Roads Classic LE .....	BTX20HL-BS		2014-08	XV1700ATS Road Star Silverado S .....	BT14B-4
	2012	Tiger 1050 ABS SE .....	BT12B-BS		2011-09	Hammer .....	BTX20HL-BS		2009-02	XV1700PC Road Star Warrior .....	BT14B-4
	2011-10	Tiger 1050 SE .....	BT12B-BS		2014-10	Hammer 8-Ball .....	BTX20HL-BS		2009-05	XV1700PCM Road Star Midnight Warrior .....	BT14B-4
1000cc	2013-11	Bonneville T100 .....	BTX12-BS		2012-08	Hammer S .....	BTX20HL-BS		2003-99	XV1600A Road Star .....	BTX20L-BS
	2010-08	Bonneville T100 .....	BT12B-BS		2013-12	Hard-Ball .....	BTX20HL-BS		2003-00	XV1600AS Road Star Midnight .....	BTX20L-BS
	2007-05	Bonneville T100 .....	BTX12-BS		2014-11	High-Ball .....	BTX20HL-BS		2003-99	XV1600AT Road Star Silverado .....	BTX20L-BS
	2012	Bonneville T100 110th Anniversary LE .....	BTX12-BS		2014	Jackpot .....	BTX20HL-BS		2005-03	FJR1300 .....	BT14B-4
	2011	Bonneville T100 Jet Black .....	BTX12-BS		2014-13	Judge .....	BTX20HL-BS		2014-04	FJR1300A ABS .....	BT14B-4
955cc	2004-99	Daytona 955i .....	BTX14-BS		2012-08	Kingpin .....	BTX20HL-BS		2009-05	FJR1300AE .....	BT14B-4
	1998	Sprint Sport .....	B14L-A2		2011-08	Kingpin 8-Ball .....	BTX20HL-BS		2014	FJR1300ES .....	BT14B-4
	2004-99	Sprint ST .....	BTX14-BS		2014	Ness Cross Country .....	BTX20HL-BS		2014-11	XVS13 Stryker .....	BTX20L-BS
	2010-09	Street Triple R .....	BTX9-BS		2012-11	Vegas .....	BTX20HL-BS		2014-11	XVS1300 V Star 1300 .....	BTX20L-BS
885cc	2002-96	Adventurer .....	B14L-A2		2014-11	Vegas 8-Ball .....	BTX20HL-BS	1600cc	2003-99	XV1600A Road Star .....	BTX20L-BS
	1996-95	Speed Triple .....	B14L-A2		2009-08	Vegas 8-Ball .....	BTX20HL-BS		2003-00	XV1600AS Road Star Midnight .....	BTX20L-BS
	1998-95	Sprint .....	B14L-A2		2013-08	Vegas Jackpot .....	BTX20HL-BS		2003-99	XV1600AT Road Star Silverado .....	BTX20L-BS
	2003-02	Thunderbird .....	B14L-A2		2011-10	Vision 8-Ball .....	BTX20HL-BS		2014-11	XVS1300 V Star 1300 .....	BTX20L-BS
865cc	2013-02	America .....	BTX12-BS		2009-08	Vision Street .....	BTX20HL-BS		2009-07	XVS1300 V Star 1300 .....	BTX20L-BS
	2011	America Classic .....	BTX12-BS		2009-08	Vision Street Premium .....	BTX20HL-BS		2014-13	XVS1300 V Star 1300 Deluxe .....	BTX20L-BS
	2013-11	Bonneville .....	BTX12-BS		2014-08	Vision Tour .....	BTX20HL-BS		2014-07	XVS1300A V Star 1300 Tourer .....	BTX20L-BS
	2010-08	Bonneville .....	BT12B-BS		2009	Vision Tour 10th Anniv. .....	BTX20HL-BS		1998-96	XVZ1300A Royal Star .....	BTX20L-BS
	2007-06	Bonneville .....	BTX12-BS		2009-08	Vision Tour Comfort .....	BTX20HL-BS		2001-99	XVZ1300AL Royal Star Boulevard .....	BTX20L-BS
	2013-11	Bonneville SE .....	BTX12-BS		2009-08	Vision Tour Premium .....	BTX20HL-BS		2000-96	XVZ1300AT Royal Star Tour Classic .....	BTX20L-BS
	2010-09	Bonneville SE .....	BT12B-BS		2013	Zach Ness Cross Country .....	BTX20HL-BS		2009-05	XVZ1300CT Royal Star Tour Deluxe .....	BTX20L-BS
	2012	Bonneville Steve McQueen SE .....	BTX12-BS		2012-11	Zach Ness Vegas .....	BTX20HL-BS		2001-97	XVZ1300CT Royal Star Tour Deluxe .....	BTX20L-BS
	2013-11	Scrambler .....	BTX12-BS		2007	Hammer S .....	BTX20HL-BS		2007-06	XVZ1300CTM Royal Star Midnight Tour Deluxe .....	BTX20L-BS
	2010-08	Scrambler .....	BT12B-BS		2007-06	Kingpin .....	BTX20L-BS		2009-08	XVZ1300CTS Royal Star Tour Deluxe S .....	BTX20L-BS
	2007-06	Scrambler .....	BTX12-BS		2007-06	Vegas 8-Ball .....	BTX20L-BS		2009-99	XVZ1300TF Royal Star Venture .....	BTX20L-BS
	2013-11	Speedmaster .....	BTX12-BS		2007-06	Vegas Jackpot .....	BTX20L-BS		2007-02	XVZ1300TFM Royal Star Midnight Venture .....	BTX20L-BS
	2013-09	Thrupton .....	BT12B-BS		2008-06	Arlen Ness Jackpot .....	BTX20HL-BS		2013-09	XVZ1300TF S Royal Star Venture S .....	BTX20L-BS
	2008-04	Thrupton .....	BTX12-BS	1635cc	2008	Cory Ness Jackpot .....	BTX20HL-BS		2007-95	VMX1200 V-Max .....	B16AL-A2
	2011	Thrupton SE .....	BT12B-BS		2008-05	Hammer .....	BTX20HL-BS				
800cc	2005-01	Bonneville .....	BTX12-BS		2006	Kingpin .....	BTX20HL-BS				
	2011	Tiger 800 .....	BTX14-BS		2009-07	Kingpin Low .....	BTX20HL-BS				
	2013-11	Tiger 800 ABS .....	BTX14-BS	1634cc	2009-07	Kingpin Tour .....	BTX20HL-BS				
	2011	Tiger 800 XC .....	BTX14-BS		2010-06	Vegas .....	BTX20HL-BS				
	2013-11	Tiger 800 XC ABS .....	BTX14-BS		2010	Vegas 8-Ball .....	BTX20HL-BS				
790cc	2010-03	Speedmaster .....	BTX12-BS		2009-08	Vegas Low .....	BTX20HL-BS				
750cc	2006-95	Tiger .....	B9-B		2003	Classic Cruiser .....	BTX20L-BS				
	1998-95	Trident .....	B9-B		2006-03	Touring Cruiser .....	BTX20L-BS				
675cc	2013-08	Daytona 675 .....	BTX9-BS		2002-98	V92C .....	BTX20L-BS				
	2007-06	Daytona 675 .....	BT7B-BS		2002-01	V92C Deluxe .....	BTX20L-BS				
	2013-11	Daytona 675 R .....	BTX9-BS		2001-00	V92SC .....	BTX20L-BS				
	2013-08	Street Triple 675 .....	BTX9-BS		2002	V92TC .....	BTX20L-BS				
	2013-11	Street Triple R .....	BTX9-BS		2002	V92TC Deluxe .....	BTX20L-BS				
650cc	2005	Daytona 650 .....	BTX9-BS		2005-03	Vegas .....	BTX20L-BS				
600cc	2004-03	Daytona 600 .....	BTX9-BS		2005-04	Kingpin .....	BTX20L-BS				
	2006-02	Speed Four .....	BTX9-BS								
	2003-00	TT600 .....	BTX12-BS								

# POWERSPORT - Motorcycle & Scooter - Utility Vehicle

ENGINE	YEAR	MODEL	JIS Battery Type	ENGINE	YEAR	MODEL	JIS Battery Type	ENGINE	YEAR	MODEL	JIS Battery Type
<b>YAMAHA (Cont.)</b>				<b>YAMAHA (Cont.)</b>				<b>Utility Vehicle</b>			
1200cc	2013-12	XTZ1200 Super Tenere	BTZ12S	500cc	2001-95	SH50 Razz	B4L-B	<b>ARCTIC CAT</b>			
1100cc	1999-97	XV1100 Virago	B50-N18L-A	2014-12	TTR50E		BT4B-5	1000cc	2014	Prowler XTZ 1000	BTX30L
	1996-95	XV1100 Virago	B50-N18L-A2	2009-06	TTR50E		BT4B-5	2011-10	Prowler XTZ 1000	B30L-B	
	2009-99	XVS1100 V Star 1100 Custom	BT14B-4	2014-13	XC50 Vino 50 Classic		BTX5L-BS	2009	Prowler XTZ 1000 Baja	B30L-B	
	2009-00	XVS1100A V Star 1100 Classic	BT14B-4	2011-06	XC50 Vino 50 Classic		BTX5L-BS	2011-09	Prowler XTZ 1000 H2 EFI	B30L-B	
	2009-02	XVS1100AT V Star 1100 Silverado	BT14B-4	2011-07	XF50 C3		BTX5L-BS	2013	Prowler XTZ 1000i	BTX30L	
1000cc	1995	FZR1000	BTX14-BS	2009-07	XP50 C3		BTX5L-BS	2012	Prowler XTZ 1000i	B30L-B	
	2014-06	FZS1000 FZ1	BTZ14S	2004-01	YJ50 Vino		BT4B-5	2002	SBS 1000	B30L-B	
	2005-01	FZS1000 FZ1	BT14B-4	2005-02	YJ50RA Vino Classic		BT4B-5	2014-12	Wildcat 1000	BTX30L	
	1997	YZF1000	BTX14-BS	2011-08	YW50 Zuma		BTX5L-BS	2014-13	Wildcat 1000 LTD	BTX30L	
	2014-04	YZF-R1	BTZ10S	2005-02	YW50 Zuma		BTX5L-BS	2014-13	Wildcat 4 1000	BTX30L	
	2003-98	YZF-R1	BT12B-4	2014-12	YW50F Zuma 50F		BTX5L-BS	2014	Wildcat 4 Limited	BTX30L	
	2010	YZF-R1 LE	BTZ10S					2014	Wildcat 4X	BTX30L	
	2006	YZF-R1 LE	BTZ10S					2014-13	Wildcat X 1000	BTX30L	
950cc	2014	XVS950 Bolt	BTZ14S					700cc	2011	Prowler HDX 700	B30L-B
	2014	XVS950 Bolt R-Spec	BTZ14S					2014	Prowler HDX 700 Limited	BTX30L	
	2013-09	XVS950 V Star 950	BTZ14S					2013	Prowler HDX 700i	BTX30L	
	2014-09	XVS950CT V Star 950 Tourer	BTZ14S					2012	Prowler HDX 700i	B30L-B	
850cc	2014	FZ-09	BTZ10S					2009	Prowler XT 700	BTX24HL-BS	
800cc	2013-11	FZ8	BTZ10S					2014	Prowler XTX 700	BTX30L	
750cc	1997-95	XV750 Virago	B16AL-A2					2011-10	Prowler XTX 700 H1 EFI	B30L-B	
	1998-95	YZF750R	BTX12-BS					2009	Prowler XTX 700 H1 EFI	BTX24HL-BS	
	1999	YZF-R7	BT9B-4					2009-08	Prowler XTX 700 LE	BTX24HL-BS	
650cc	2014-13	XVS650 V Star Custom	BT12B-4					2013	Prowler XTX 700i	BTX30L	
	2011-98	XVS650 V Star Custom	BT12B-4					2012	Prowler XTX 700i	B30L-B	
	2010-98	XVS650A V Star Classic	BT12B-4					650cc	2008	Prowler 650 4x4 Auto	B50N-18L-LM
	2010-02	XVS650AT V Star Silverado	BT12B-4					2007-06	Prowler 650 H1	B50N-18L-LM	
600cc	2014-09	FZ6R	BT12B-4					2008	Prowler XT 650 4x4 Auto	B50N-18L-LM	
	1999-95	FZR600R	B12AL-A2					2008	Prowler XT 650	B50N-18L-LM	
	2009-04	FZS600 FZ6	BT12B-4					2009	Prowler XT 650 H1	B50N-18L-LM	
	1998-95	XJ600S Seca II	BTX9-BS					2007-06	Prowler XT 650 H1	B50N-18L-LM	
	1995	XT600	BTX9-BS					550cc	2009	Prowler 550	BTX24HL-BS
	2007-95	YZF600R	BTX12-BS					2014	Prowler XT 550	BTX30L	
	2014-06	YZF-R6	BTZ10S					2011-10	Prowler XT 550	B30L-B	
	2005-01	YZF-R6	BT9B-4					2013	Prowler XT 550i	BTX30L	
	2000-99	YZF-R6	BT12B-4					2012	Prowler XT 550i	B30L-B	
	2009-06	YZF-R6S	BT9B-4					500cc	2014	Prowler HDX 500	BTX30L
535cc	2000-95	XV535 Virago	B12AL-A2					2014	Prowler HDX 500 Limited	BTX30L	
500cc	2011-09	XP500 TMAX	BTZ10S					2014	Prowler HDX 500 XT	BTX30L	
450cc	2014-11	WR450F	BTZ7S					<b>ARGO</b>			
	2009-03	WR450F	BTZ7S					775cc	2007	Jim Shockey Limited Edition Signature Series	45
400cc	2014-12	YP400 Majesty	BT9B-4					750cc	2010	750 HDi 8x8	45
	2010-05	YP400 Majesty	BT9B-4					2010	750 HDi 8x8 (Optional)	51	
350cc	2000-95	XT350	B3L-B					2010	750 HDi 8x8 Special Edition	45	
250cc	2008-06	CP250 Morphous	BTZ10S					2010	750 HDi 8x8 Special Edition (Optional)	51	
	2006-99	TTR250	BT7B-4					2013-11	8x8 750 HDi	45	
	2013-11	WR250F	BTZ7S					2013-11	8x8 750 HDi (Optional)	51	
	2009-08	WR250F	BTZ7S					2013-11	8x8 750 HDi SE	45	
	2007-03	WR250F	BTX5L-BS					2013-11	8x8 750 HDi SE (Optional)	51	
	2014-08	WR250R	BTZ7S					2013	8x8 XTi	34	
	2011-08	WR250X	BTZ7S					2013	Avenger 750 EFI 8x8	45	
	2014-08	XT250	BTZ7S					2011-07	Avenger 750 EFI 8x8 (Optional)	51	
	2014-08	XV250 V Star 250	B10L-A2					2011-10	Avenger 750 EFI 8x8 (Optional)	51	
	2007-95	XV250 Virago	B10L-A2					700cc	2013-11	8x8 700 HD	45
230cc	2014-11	TTR230	BTX5L-BS					2013-11	8x8 700 HD (Optional)	51	
	2009-05	TTR230	BTX5L-BS					2011-06	Avenger 700 8x8	45	
225cc	2004-99	TTR225	BT7B-4					2011-10	Avenger 700 8x8 (Optional)	51	
	2007-01	XT225	BTZ7S					650cc	2013-11	6x6 650 HD	45
	2000-95	XT225	BTX7L-BS					2013-11	6x6 650 HD (Optional)	51	
200cc	2014-95	TW200	B7C-A					2010-08	Frontier 650 6x6	45	
125cc	2009-03	TTR125E	BTX4L-BS					2010	Frontier 650 6x6 (Optional)	51	
	2014-11	TTR125LE	BTX4L-BS					2013-08	Frontier 650 8x8	45	
	2009-03	TTR125LE	BTX4L-BS					2013-10	Frontier 650 8x8 (Optional)	51	
	2001-95	XC125 Riva 125	B7C-A					2007	Frontier 6x6	45	
	2009-04	YJ125 Vino 125	BTX7A-BS								
	2014-09	YW125 Zuma 125	BT7B-BS								
110cc	2014-11	TTR110E	BT4B-5								
	2009-08	TTR110E	BT4B-5								
90cc	2007-03	TTR90E	BT4B-5								
50cc	2012	BW5 50	BTX5L-BS								
	2001-97	CW50 Zuma II	B4L-B								
	2001-95	CY50 Jog	BTX4L-BS								

# POWERSPORT - Utility Vehicle

ENGINE	YEAR	MODEL	JIS Battery Type	ENGINE	YEAR	MODEL	JIS Battery Type	ENGINE	YEAR	MODEL	JIS Battery Type
<b>ARGO (Cont.)</b>				<b>KAWASAKI (Cont.)</b>				<b>KAWASAKI (Cont.)</b>			
617cc	2006	Conquest 6x6	45	800cc	2014	KRT800 Teryx LE (Can.)	BTX20L-BS	400cc	2014-05	KAF400 Mule 600	B14A-A2
	2006	Conquest 8x8	45						2014-05	KAF400 Mule 610 4x4	B14A-A2
580cc	2013-08	Frontier 580 6x6	45		2014	KRT800 Teryx LE (US)	U1		2014-10	KAF400 Mule 610 4x4 XC	B14A-A2
	2013-10	Frontier 580 6x6 (Optional)	51		2014	KRT800 Teryx4 (Can.)	BTX20L-BS		2014	KAF400 Mule 610 4x4 XC SE	B14A-A2
570cc	2006	Bigfoot 6x6	45		2014	KRT800 Teryx4 (US)	U1	300cc	1995	KAF300 Mule 500	B14A-A2
	2007	Response 8x8	45		2014	KRT800 Teryx4 Camo (Can.)	BTX20L-BS		2001-00	KAF300 Mule 520	B14A-A2
480cc	2007-06	Vanguard 2 6x6	45		2014	KRT800 Teryx4 Camo (US)	U1		2004-03	KAF300 Mule 550	B14A-A2
	2007-06	Vanguard 6x6	45		2014	KRT800 Teryx4 LE (Can.)	BTX20L-BS		2001-97	KAF300 Mule 550	B14A-A2
<b>BOBCAT</b>				<b>KAWASAKI (Cont.)</b>				<b>KAWASAKI (Cont.)</b>			
	2012-08	Toolcat 5600	24		2014	KRT800 Teryx4 LE (US)	U1	<b>KYMCO</b>			
	2012-08	Toolcat 5600 (Optional)	31A	750cc	2009-08	KRF750 Teryx 4x4 (Can.)	BTX14-BS	500cc	2014-09	UXV 500 4X4	BTX20L-BS
	2012-08	Toolcat 5610	24		2009-08	KRF750 Teryx 4x4 (US)	U1		2011-10	UXV 500 4X4 LE	BTX20L-BS
	2012-08	Toolcat 5610 (Optional)	31A		2013-09	KRF750 Teryx FI 4x4 (Can.)	BTX14-BS		2011	UXV 500 4X4 SE	BTX20L-BS
<b>CAN-AM</b>					2013-09	KRF750 Teryx FI 4x4 (US)	U1		2014-12	UXV 500i 4X4	BTX20L-BS
1000cc	2014-11	Commander 1000	BTX20L		2013-09	KRF750 Teryx FI 4x4 (US)	U1		2014	UXV 500i HE	BTX20L-BS
	2014	Commander 1000 DPS	BTX20L		2013-08	KRF750 Teryx FI 4x4 LE (Can.)	BTX14-BS		2014-12	UXV 500i LE	BTX20L-BS
	2014-12	Commander 1000 LTD	BTX20L		2013-08	KRF750 Teryx FI 4x4 LE (Can.)	BTX14-BS		2013-12	UXV 500i SE	BTX20L-BS
	2013-11	Commander 1000 X	BTX20L		2013-08	KRF750 Teryx FI 4x4 LE (US)	U1		2014-13	UXV 500i SP	BTX20L-BS
	2014-11	Commander 1000 XT	BTX20L		2013	KRF750 Teryx FI 4x4 LE Camo (Can.)	BTX14-BS		2014	UXV 500i TURF	BTX20L-BS
	2014	Commander 1000 XT-P	BTX20L		2013	KRF750 Teryx FI 4x4 LE Camo (US)	U1	<b>POLARIS</b>			
	2013	Commander DPS 1000	BTX20L		2012-11	KRF750 Teryx FI 4x4 LE SGE (Can.)	BTX14-BS	900cc	2013-12	Ranger RZR XP 4 900 EPS LE	BTX30L
	2014	Commander Max 1000 DPS	BTX20L		2012-11	KRF750 Teryx FI 4x4 LE SGE (US)	U1		2013-11	Ranger RZR XP 900	BTX30L
	2014	Commander Max 1000 XT	BTX20L		2009	KRF750 Teryx FI 4x4 LE Sport (Can.)	BTX14-BS		2013	Ranger RZR XP 900 EPS LE	BTX30L
800cc	2014-11	Commander 800R	BTX20L		2009	KRF750 Teryx FI 4x4 LE Sport (US)	U1		2013	Ranger RZR XP 900 HO	BTX30L
	2014-11	Commander 800R XT	BTX20L		2013-09	KRF750 Teryx FI 4x4 Sport (Can.)	BTX14-BS		2013-11	Ranger RZR XP 900 LE	BTX30L
	2014-13	Commander DPS 800R	BTX20L		2013-09	KRF750 Teryx FI 4x4 Sport (US)	U1		2014	RZR 4 900 EPS LE	BTX30L
<b>E-TON</b>					2009-08	KRF750 Teryx NRA Outdoors (Can.)	BTX14-BS	800cc	2014	RZR 900 EPS LE	BTX30L
90cc	2010-07	Rover	BTX5L-BS		2009-08	KRF750 Teryx NRA Outdoors (US)	U1		2013-12	Ranger RZR 4 800 EPS LE	BTX30L
	2010-07	Rover GT	BTX5L-BS		2012	KRT750 Teryx4 4x4 (Can.)	BTX14-BS		2011	Ranger RZR 4 800 EPS Robby Gordon	BTX30L
<b>HONDA</b>					2012-12	KRT750 Teryx4 4x4 (US)	U1		2012	Ranger RZR 4 800 EPS Robby Gordon LE	BTX30L
700cc	2013-09	MUV700 Big Red	BTX14-BS		2013-12	KRT750 Teryx4 4x4 EPS (Can.)	BTX14-BS		2012-10	Ranger RZR 4 800 Gordon Edition	BTX30L
	2014	SXS700M2 Pioneer 700	BTX14-BS		2013-12	KRT750 Teryx4 4x4 EPS (US)	U1		2013-08	Ranger RZR 800	BTX20HL-BS
	2014	SXS700M4 Pioneer 700-4	BTX14-BS		2013	KRT750 Teryx4 4x4 EPS Camo (Can.)	BTX14-BS		2011-10	Ranger RZR 800 EPS	BTX20HL-BS
<b>JOHN DEERE</b>					2013	KRT750 Teryx4 4x4 EPS Camo (US)	U1		2013-12	Ranger RZR 800 EPS LE	BTX20HL-BS
	2011-10	Gator TE 4x2 Electric (8 batteries required)	GC2		2013-12	KRT750 Teryx4 4x4 EPS LE (Can.)	BTX14-BS		2013-12	Ranger RZR 800 LE	BTX20HL-BS
1120cc	2011-10	ProGator 2030A Diesel	U1		2013-12	KRT750 Teryx4 4x4 EPS LE (US)	U1		2013-09	Ranger RZR 800 S	BTX30L
900cc	2011-10	ProGator 2020A	U1		2012	KRT750 Teryx4 4x4 EPS LE Camo (Can.)	BTX14-BS		2013-12	Ranger RZR 800 S LE	BTX30L
855cc	2011	Gator XUV 855D 4x4 Diesel	U1		2012	KRT750 Teryx4 4x4 EPS LE Camo (US)	U1		2013	Ranger RZR S 800 EPS LE	BTX30L
850cc	2011-10	Gator HPX 4x4 Diesel	U1		2012	KRT750 Teryx4 4x4 EPS LE Camo (US)	U1		2009	Ranger RZR S Military	BTX30L
	2011-10	Gator TH 6x4 Diesel	U1		2014	KAF620 Mule 2500	B16CL-B		2014	RZR 4 800 EPS LE	BTX30L
	2010	Gator XUV 850D 4x4 Diesel	U1		2000-97	KAF620 Mule 2510 4x4	B16CL-B		2014	RZR S 800	BTX30L
825cc	2011	Gator XUV 825i 4x4	U1		1995	KAF620 Mule 2510 4x4	B16CL-B		2014	RZR S 800 EPS LE	BTX30L
675cc	2011-10	Gator TH 6x4	U1		2000-97	KAF620 Mule 2520	B16CL-B		2007	Ranger 4x4 700 EFI	BTX30L
	2011-10	Gator TX 4x2	U1		1995	KAF620 Mule 2520	B16CL-B		2009-06	Ranger 6x6 700 EFI	BTX30L
650cc	2011-10	Gator HPX 4x4	U1		2008-01	KAF620 Mule 3000	BTX20L-BS		2009-08	Ranger Crew 700	BTX30L
625cc	2011	Gator XUV 625i 4x4	U1		2008-01	KAF620 Mule 3010	BTX20L-BS		2009-05	Ranger XP 700	BTX30L
620cc	2010	Gator XUV 620i 4x4	U1		2008-01	KAF620 Mule 3010 4x4	BTX20L-BS		2014	Ranger 570 Crew	B14-B2
400cc	2011-10	Gator TX 4x2 Turf	U1		2008-05	KAF620 Mule 3010 Trans 4x4	BTX20L-BS		2014	Ranger 570 Crew EPS LE	B14-B2
350cc	2011-10	Gator TS 4x2	U1		2003-01	KAF620 Mule 3020	BTX20L-BS		2014	Ranger 570 EFI	B14-B2
300cc	2011-10	Gator CX 4x2	B16CL-B		2014-09	KAF620 Mule 4000	U1		2014	Ranger 570 EPS LE	B14-B2
<b>KAWASAKI</b>					2014-09	KAF620 Mule 4010 4x4 (Canada)	BTX20L-BS		2013-12	Ranger RZR 570	B14-B2
950cc	2002-00	KAF950 Mule 2510 Diesel 4x4	26R		2014-09	KAF620 Mule 4010 Trans 4x4 (Canada)	BTX20L-BS		2013	Ranger RZR 570 EPS Trail LE	B14-B2
	2008-03	KAF950 Mule 3010 Diesel 4x4	26R		2014-09	KAF620 Mule 4010 4x4 (USA)	U1		2014	RZR 570	B14-B2
	2008-07	KAF950 Mule 3010 Trans 4x4 Diesel	26R		2014-09	KAF620 Mule 4010 Trans 4x4 (USA)	U1		2007-04	Ranger 4x4 500	BTX30L
	2013-09	KAF950 Mule 4010 Diesel 4x4	26R		2014-09	KAF620 Mule 4010 Trans 4x4 (Canada)	BTX20L-BS		2004-01	Ranger 4x4 500	B30L-B
	2013	KAF950 Mule 4010 Trans 4x4 Diesel	26R		2014-09	KAF620 Mule 4010 Trans 4x4 (USA)	U1		2011-06	Ranger 4x4 500 EFI	BTX30L
	2011-09	KAF950 Mule 4010 Trans 4x4 Diesel	26R						2013-11	Ranger 500 Crew	B14-B2
800cc	2014	KRT800 Teryx (Can.)	BTX20L-BS								
	2014	KRT800 Teryx (US)	U1								
	2014	KRT800 Teryx Camo (Can.)	BTX20L-BS								
	2014	KRT800 Teryx Camo (US)	U1								

# POWERSPORT - Utility Vehicle - ATV

ENGINE	YEAR	MODEL	JIS Battery Type	ENGINE	YEAR	MODEL	JIS Battery Type	ENGINE	YEAR	MODEL	JIS Battery Type
<b>POLARIS (Cont.)</b>				<b>ATV</b>				<b>ARCTIC CAT (Cont.)</b>			
500cc	2013	Ranger 500 Crew LE	B14-B2	<b>ARCTIC CAT</b>				650cc	2006-04	650 V-2 4x4 Auto	B14-A2
	2012	Ranger 500 Crew Turbo Silver LE	B14-B2	1000cc	2011-10	1000 EFI H2 4x4 Auto Mud Pro	BTX20H-BS	2006-04	650 V-2 4x4 Auto LE/TS	B14-A2	
	2013-12	Ranger 500 EFI	B14-B2		2011-10	1000 EFI H2 4x4 Auto TRV	BTX20H-BS	2004	650 V-2 4x4 Auto MRP	B14-A2	
	2013-12	Ranger 500 EFI LE	B14-B2		2011	1000 LTD	BTX20H-BS	2011	MudPro 650	B18-A	
	2005-98	Ranger 6x6 500	B30L-B		2011-09	1000 TRV Cruiser	BTX20H-BS	2014	550	BTX20H-BS	
425cc	2004-02	Ranger 2x4 425	B30L-B		2012	1000i GT	BTX20H-BS	2012	550	BTX20H-BS	
400cc	2014-11	Ranger 4x4 400	B14-B2		2011-09	1000 TRV Cruiser	BTX20H-BS	2011-09	550 4x4 Auto	BTX20H-BS	
	2010	Ranger 4x4 400	BTX30L		2014-13	1000 XT	BTX20H-BS	2010-09	550 4x4 Auto LE	BTX20H-BS	
170cc	2013-09	Ranger RZR 170	BTX12-BS		2012	1000i GT	BTX20H-BS	2011-09	550 4x4 Auto TRV	BTX20H-BS	
	2014	RZR 170	BTX12-BS		2011	MudPro 1000	BTX20H-BS	2009	550 4x4 Auto TRV LE	BTX20H-BS	
<b>SUZUKI</b>					2014-12	MudPro 1000i LTD	BTX20H-BS	2013	550 Core	BTX20H-BS	
620cc	2005	QUV620F	BTX20L-BS		2010-08	Thundercat 1000 4x4 Auto	BTX20H-BS	2009	550 H1 EFI	BTX20H-BS	
<b>YAMAHA</b>					2010	Thundercat 1000 4x4 Auto LE	BTX20H-BS	2011	550 LTD	BTX20H-BS	
1000cc	2005-04	YXP1000A Pro Hauler 1000	U1		2014-13	TRV 1000 LTD	BTX20H-BS	2011	550 S	BTX20H-BS	
700cc	2014	YXM700 Viking FI 4x4	U1		2012	TRV 1000i Cruiser	BTX20H-BS	2011	550 TRV Cruiser	BTX20H-BS	
	2014	YXM700 Viking FI 4x4 EPS	U1		2012	TRV 1000i GT	BTX20H-BS	2011	550 TRV GT	BTX20H-BS	
	2014	YXM700 Viking FI 4x4 EPS with Suntop	U1	700cc	2014	700	BTX20H-BS	2014-13	550 XT	BTX20H-BS	
	2014	YXM700 Viking FI 4x4 with Suntop	U1		2011	700	BTX20H-BS	2012	550i GT	BTX20H-BS	
	2006-04	YXP700A Pro Hauler 700	U1		2013	700 Core	BTX20H-BS	2013-12	550i LTD	BTX20H-BS	
	2013-11	YXR700F Rhino 700 FI	U1		2008-07	700 Diesel	BTX24HL-BS	2014-13	TRV 550 LTD	BTX20H-BS	
	2009-08	YXR700F Rhino 700 FI	U1		2008-07	700 EFI 4x4 Auto	B18-A	2014-13	TRV 550 XT	BTX20H-BS	
	2009-08	YXR700F Rhino 700 FI Ducks Unlimited	U1		2007	700 EFI 4x4 Auto LE	B18-A	2012	TRV 550i Crusier	BTX20H-BS	
	2013	YXR700F Rhino 700 FI Special Edition	U1		2008	700 EFI 4x4 Auto M4	B18-A	2012	TRV 550i GT	BTX20H-BS	
	2009-08	YXR700F Rhino 700 FI Special Edition	U1		2006	700 EFI 4x4 Auto SE	B18-A	2009-98	500 4x4	B14-A2	
	2013-11	YXR700F Rhino 700 FI Sport Edition	U1		2011-09	700 EFI 4x4 Auto TRV Cruiser	BTX20H-BS	2009-00	500 4x4 Auto	B14-A2	
	2009-08	YXR700F Rhino 700 FI Sport Edition	U1		2008	700 EFI 4x4 Auto TRV Cruiser	B18-A	2002	500 4x4 Auto FIS	B14-A2	
660cc	2007-04	YXR66F Rhino 660	U1		2008	700 EFI 4x4 Auto TRV LE	B18-A	2006-05	500 4x4 Auto LE	B14-A2	
	2007	YXR66F Rhino 660 Ducks Unlimited	U1		2010-09	700 EFI H1 4x4 Auto	BTX20H-BS	2008	500 4x4 Auto M4	B14-A2	
	2007-06	YXR66F Rhino 660 Exploring Edition	U1		2010-09	700 EFI H1 4x4 Auto LE	BTX20H-BS	2004-03	500 4x4 Auto MRP	B14-A2	
	2007-06	YXR66F Rhino 660 Special Edition	U1		2011-09	700 EFI H1 4x4 Auto Mud Pro	BTX20H-BS	2006-02	500 4x4 Auto TBX	B14-A2	
	2007	YXR66F Rhino 660 Sport Edition	U1		2010-09	700 EFI H1 4x4 Auto LE	BTX20H-BS	2008	500 4x4 Auto TRV	B14-A2	
450cc	2009-06	YXR45F Rhino 450	U1		2011-09	700 EFI H1 4x4 Auto SE	BTX20H-BS	2006-03	500 4x4 Auto TRV	B14-A2	
	2008-07	YXR45F Rhino 450 Special Edition	U1		2009-08	700 EFI H1 4x4 Auto SE	BTX20H-BS	2002	500 4x4 FIS	B14-A2	
					2010	700 EFI H1 4x4 Auto TBX	BTX20H-BS	2004-03	500 4x4 MRP	B14-A2	
					2011-09	700 EFI H1 4x4 Auto TRV	BTX20H-BS	2013	500 Core	BTX20H-BS	
					2014	700 LTD	BTX20H-BS	2014-13	500 XT	BTX20H-BS	
					2011	700 LTD	BTX20H-BS	2013	TRV 500 Core	BTX20H-BS	
					2011-10	700 S	BTX20H-BS	1998-97	Bearcat 454 2x4	B14-A2	
					2014-10	700 Super Duty Diesel	BTX24HL-BS	1998-96	Bearcat 454 4x4	B14-A2	
					2011-10	700 TRV GT	BTX20H-BS	2014	450	BTX20H-BS	
					2014-13	700 XT	BTX20H-BS	2011	450	BTX20H-BS	
					2012	700i	BTX20H-BS	2013	450 Core	BTX20L-BS	
					2012	700i GT	BTX20H-BS	2010	450 EFI H1 4x4 Auto	BTX20H-BS	
					2013-12	700i LTD	BTX20H-BS	2011	450 LTD	BTX20H-BS	
					2011	MudPro 700	BTX20H-BS	2011	450 TRV	BTX20H-BS	
					2012	MudPro 700i	BTX20H-BS	2012	450i	BTX20H-BS	
					2014-12	MudPro 700i LTD	BTX20H-BS	2012	450i GT	BTX20H-BS	
					2014	TBX 700	BTX20H-BS	2012	TRV 450i	BTX20H-BS	
					2011	TBX 700 LTD	BTX20H-BS	2012	TRV 450i GT	BTX20H-BS	
					2013	TBX 700 XT	BTX20H-BS	2014-11	XC 450i	BTX20L-BS	
					2012	TBX 700i GT	BTX20H-BS	2011	425	BTX20L-BS	
					2014-13	TRV 700 LTD	BTX20H-BS	2012	425i	BTX20L-BS	
					2014-13	TRV 700 XT	BTX20H-BS	2012	425i SE	BTX20L-BS	
					2012	TRV 700i Cruiser	BTX20H-BS	400cc	400	B14-A2	
					2012	TRV 700i GT	BTX20H-BS	2004-98	400 2x4	B14-A2	
					2004	650 4x4 Auto	B14-A2	2004-03	400 2x4 Auto	B14-A2	
					2004	650 4x4 Auto LE	B14-A2	2002	400 2x4 FIS	B14-A2	
					2009	650 4x4 Auto TBX	B14-A2	2007-98	400 4x4	B14-A2	
					2011-10	650 H1 4x4 Auto	B18-A	2004-03	400 4x4 ACT	B14-A2	
					2008-05	650 H1 4x4 Auto	B14-A2	2008-02	400 4x4 Auto	B14-A2	
					2007	650 H1 4x4 Auto LE	B14-A2	2004-03	400 4x4 Auto ACT	B14-A2	
					2011-10	650 H1 4x4 Auto Mud Pro	B18-A	2007-05	400 4x4 Auto LE	B14-A2	
					2006	650 H1 4x4 Auto SE	B14-A2	2004-03	400 4x4 Auto MRP	B14-A2	
					2007	650 H1 4x4 Auto TBX	B14-A2	2006-04	400 4x4 Auto TBX	B14-A2	
					2009-08	650 H1 4x4 Auto TRV	B14-A2	2010-06	400 4x4 Auto TRV	B14-A2	
					2007	650 H1 4x4 Auto TRV Plus	B14-A2	2007	400 4x4 Auto TRV Plus	B14-A2	
					2007	650 H1 4x4 Auto TRV Plus LE	B14-A2	2006-05	400 4x4 Auto VP	B14-A2	
								2002	400 4x4 FIS	B14-A2	
								2004-03	400 4x4 MRP	B14-A2	
								2006-05	400 4x4 VP	B14-A2	
								2013	400 Core	B14-A2	
								2008-04	DVX 400	BTX9-BS	
								2007-06	DVX 400 TS	BTX9-BS	
								2014	TRV 400	B14-A2	
								2013	TRV 400 Core	B14-A2	

# POWERSPORT - ATV

ENGINE	YEAR	MODEL	JIS Battery Type	ENGINE	YEAR	MODEL	JIS Battery Type	ENGINE	YEAR	MODEL	JIS Battery Type
<b>ARCTIC CAT (Cont.)</b>				<b>BOMBARDIER (Cont.)</b>				<b>CAN-AM (Cont.)</b>			
375cc	2002	375 Auto 2x4	B14-A2	500cc	2005-03	Traxter Max 500 4x4 Auto	B16CL-B	800cc	2014-11	Outlander Max 800R EFI XT	BTX20L-BS
	2002	375 Auto 4x4	B14-A2		2005-03	Traxter Max 500 4x4 Auto (Optional)	B50-N18L-A3		2014-10	Outlander Max 800R EFI XT-P	BTX20L-BS
366cc	2009-08	366 4x4 Auto	B14-A2		2005-04	Traxter Max 500 4x4 Auto XT	B16CL-B		2010-07	Renegade 800	BTX20L-BS
	2011-10	366 4x4 Auto SE	B14-A2		2005-04	Traxter Max 500 4x4 Auto XT (Optional)	B50-N18L-A3		2010-08	Renegade 800 X	BTX20L-BS
350cc	2012-11	350	B14-A2		2005-04	Traxter Max 500 4x4 Auto XT	B16CL-B		2011-10	Renegade 800 X xc	BTX20L-BS
300cc	2014-10	300	BTX12-BS		2005-04	Traxter Max 500 4x4 Auto XT	B16CL-B		2014-11	Renegade 800R	BTX20L-BS
	2003-98	300 2x4	B14L-A2		2005-04	Traxter Max 500 4x4 Auto XT	B16CL-B		2012	Renegade 800R EFI X xc	BTX20L-BS
	2010	300 2x4 Auto	BTX12-BS	400cc	2004-03	Outlander 400 HO 2x4	BTX15L-BS	650cc	2014-13	Renegade 800R X xc	BTX20L-BS
	2005-98	300 4x4	B14L-A2		2006-05	Outlander 400 HO 4x4	BTX20L-BS		2007	DS 650 X	BTX15L-BS
	2004	300 4x4 MRP	B14L-A2		2004-03	Outlander 400 HO 4x4	BTX20L-BS		2014-11	Outlander 650 EFI	BTX20L-BS
	2014-09	DVX 300	BTX12-BS		2006-03	Outlander 400 HO 4x4 XT	BTX15L-BS		2014-13	Outlander 650 EFI DPS	BTX20L-BS
250cc	2009-06	250 2x4	BTX12-BS		2006-04	Outlander Max 400 HO	BTX20L-BS		2011-10	Outlander 650 EFI XT-P	BTX20L-BS
	2005-99	250 2x4	B14L-A2		2006-04	Outlander Max 400 HO XT	BTX20L-BS		2010-07	Outlander 650 HO 4x4 EFI	BTX20L-BS
	2005-01	250 4x4	B14L-A2	330cc	2005-03	Outlander 330 HO 2x4	BTX15L-BS		2010-07	Outlander 650 HO 4x4 EFI XT	BTX20L-BS
	2008-06	DVX 250	BTX12-BS		2005-03	Outlander 330 HO 4x4	BTX15L-BS		2014-13	Outlander 650 X mr	BTX20L-BS
150cc	2014-09	150 2x4	BTX9-BS		2006-03	DS250	BTX12-BS		2014-11	Outlander Max 650 EFI	BTX20L-BS
90cc	2004-02	90 2x4	BTX4L-BS		2006-02	Rally 200	B14A-A2		2014-13	Outlander Max 650 EFI DPS	BTX20L-BS
	2014-10	90 2x4 4-Stroke	BTX5L-BS		2006-02	DS90	BTX4L-BS		2014-11	Outlander Max 650 EFI XT	BTX20L-BS
	2008-04	90 2x4 4-Stroke	BTX5L-BS		2006-02	DS90 4-Stroke	BTX4L-BS		2012-10	Outlander Max 650 EFI XT-P	BTX20L-BS
	2009	90 2x4 SE	BTX5L-BS		2004	Quest 90	BTX4L-BS		2010-07	Outlander Max 650 HO EFI	BTX20L-BS
	2014-10	DVX 90	BTX5L-BS		2004	Quest 90 4-stroke	BTX4L-BS		2010-07	Outlander Max 650 HO EFI	BTX20L-BS
	2008-06	DVX 90	BTX5L-BS		2006-02	DS50	BTX4L-BS		2010-07	Outlander Max 650 HO EFI	BTX20L-BS
	2009	DVX 90 SE	BTX5L-BS		2004-03	Quest 50	BTX4L-BS		2010-07	Outlander Max 650 HO EFI	BTX20L-BS
50cc	2008	50 2x4	BTX5L-BS						2010-07	Outlander Max 650 HO EFI	BTX20L-BS
	2006	50 2x4	BTX5L-BS						2010-07	Outlander Max 650 HO EFI	BTX20L-BS
	2005-04	50 2x4	BTX4L-BS						2010-07	Outlander Max 650 HO EFI	BTX20L-BS
	2006	DVX 50	BTX5L-BS						2010-07	Outlander Max 650 HO EFI	BTX20L-BS
<b>BOMBARDIER</b>				<b>CAN-AM</b>							
800cc	2006	Outlander 800 HO EFI 4x4	BTX20L-BS	1000cc	2012	Outlander 1000 EFI	BTX20L	500cc	2014-11	Outlander 500 EFI	BTX20L-BS
	2006	Outlander 800 HO EFI 4x4 XT	BTX20L-BS		2014-13	Outlander 1000 EFI XT	BTX20L		2014-13	Outlander 500 EFI DPS	BTX20L-BS
	2006	Outlander Max 800 HO EFI 4x4	BTX20L-BS		2014-13	Outlander 1000 EFI XT-P	BTX20L		2014-11	Outlander 500 EFI XT	BTX20L-BS
	2006	Outlander Max 800 HO EFI 4x4 XT	BTX20L-BS		2014-13	Outlander 1000 X mr	BTX20L		2010-07	Outlander 500 HO 4x4 EFI	BTX20L-BS
650cc	2005-00	DS650	BTX15L-BS		2014-13	Outlander Max 1000 EFI DPS	BTX20L		2010-07	Outlander 500 HO 4x4 EFI XT	BTX20L-BS
	2004-01	DS650 Baja	BTX15L-BS		2014-12	Outlander Max 1000 EFI XT	BTX20L		2010-07	Outlander 500 HO 4x4 EFI XT	BTX20L-BS
	2004	DS650 Baja X	BTX15L-BS		2014-13	Outlander Max 1000 EFI XT-P	BTX20L		2010	Outlander 500 HO 4x4 EFI XT-P	BTX20L-BS
	2003-00	DS650 Racer	BTX15L-BS		2014-12	Renegade 1000	BTX20L		2014-13	Outlander Max 500 EFI	BTX20L-BS
	2006-05	DS650 X	BTX15L-BS		2012	Renegade 1000 EFI X xc	BTX20L		2011	Outlander Max 500 EFI	BTX20L-BS
	2006	Outlander 650 HO EFI 4x4	BTX20L-BS		2014-13	Renegade 1000 X xc	BTX20L		2014-13	Outlander Max 500 EFI DPS	BTX20L-BS
	2006	Outlander 650 HO EFI 4x4 XT	BTX20L-BS	800cc	2010-07	Outlander 800 HO 4x4 EFI	BTX20L-BS		2014-11	Outlander Max 500 EFI XT	BTX20L-BS
	2006	Outlander 650 HO EFI 4x4 XT	BTX20L-BS		2010-07	Outlander 800 HO 4x4 EFI XT	BTX20L-BS		2010-07	Outlander Max 500 HO EFI	BTX20L-BS
	2006	Outlander Max 650 HO EFI 4x4	BTX20L-BS		2014-11	Outlander 800R EFI	BTX20L-BS		2010	Outlander Max 500 HO EFI LTD	BTX20L-BS
	2006	Outlander Max 650 HO EFI 4x4 XT	BTX20L-BS		2014-13	Outlander 800R EFI X mr	BTX20L-BS		2010-07	Outlander Max 500 HO EFI XT	BTX20L-BS
	2006	Outlander Max 650 HO EFI 4x4 XT	BTX20L-BS		2014-11	Outlander 800R EFI X xc	BTX20L-BS		2010	Outlander Max 500 HO EFI XT-P	BTX20L-BS
	2004-02	Quest 650 4x4 (Optional)	B16CL-B		2014-12	Renegade 1000	BTX20L		2014-13	Outlander Max 500 EFI	BTX20L-BS
	2004-02	Quest 650 4x4 (Optional)	B50-N18L-A3		2012	Renegade 1000 EFI X xc	BTX20L		2011	Outlander Max 500 EFI	BTX20L-BS
	2004	Quest 650 4x4 Max	B16CL-B		2014-13	Renegade 1000 X xc	BTX20L		2014-13	Outlander Max 500 EFI DPS	BTX20L-BS
	2004	Quest 650 4x4 Max (Optional)	B50-N18L-A3		2010-07	Outlander 800 HO 4x4 EFI	BTX20L-BS		2014-11	Outlander Max 500 EFI XT	BTX20L-BS
	2004-02	Quest 650 4x4 XT (Optional)	B16CL-B		2014-11	Outlander 800R EFI	BTX20L-BS		2010-07	Outlander Max 500 HO EFI	BTX20L-BS
	2004-02	Quest 650 4x4 XT (Optional)	B50-N18L-A3		2014-13	Outlander 800R EFI XT-P	BTX20L-BS		2010	Outlander Max 500 HO EFI LTD	BTX20L-BS
500cc	2004-02	Quest 500 4X4 (Optional)	B16CL-B		2014-13	Outlander 800R EFI XT-P	BTX20L-BS	450cc	2014	DS 450	BT7B-BS
	2004-02	Quest 500 4X4 (Optional)	B50-N18L-A3		2011-10	Outlander 800R EFI XT-P	BTX20L-BS		2011-08	DS 450	BT7B-BS
	2004-02	Quest 500 4x4 XT (Optional)	B16CL-B		2010-07	Outlander Max 800 HO EFI	BTX20L-BS		2012	DS 450 EFI	BT7B-BS
	2004-02	Quest 500 4x4 XT (Optional)	B50-N18L-A3		2010-07	Outlander Max 800 HO EFI LTD	BTX20L-BS		2012	DS 450 EFI X mx	BT7B-BS
	2005-99	Traxter 500 4x4 Auto	B16CL-B		2010-07	Outlander Max 800 HO EFI XT	BTX20L-BS		2012	DS 450 EFI X xc	BT7B-BS
	2005-02	Traxter 500 4x4 Auto (Optional)	B50-N18L-A3		2010-07	Outlander Max 800 HO EFI LTD	BTX20L-BS		2008	DS 450 X	BT7B-BS
	2005-01	Traxter 500 4x4 Auto XT	B16CL-B		2010-07	Outlander Max 800R HO EFI	BTX20L-BS		2014-13	DS 450 X mx	BT7B-BS
	2005-02	Traxter 500 4x4 Auto XT (Optional)	B50-N18L-A3		2010-07	Outlander Max 800R HO EFI XT	BTX20L-BS		2011-09	DS 450 X mx	BT7B-BS
	2005	Traxter 500 Auto 4x4 CVT	B16CL-B		2010-07	Outlander Max 800R HO EFI XT	BTX20L-BS		2014	DS 450 X xc	BT7B-BS
	2005	Traxter 500 Auto 4x4 CVT (Optional)	B50-N18L-A3		2012-11	Outlander Max 800R EFI	BTX20L-BS	400cc	2011-09	DS 450 X xc	BT7B-BS
	2005-99	Traxter 500 XL	B16CL-B		2014-13	Outlander Max 800R EFI DPS	BTX20L-BS		2014-11	Outlander 400 EFI XT	BTX20L-BS
	2005-02	Traxter 500 XL (Optional)	B50-N18L-A3		2012-11	Outlander Max 800R EFI LTD	BTX20L-BS		2008-07	Outlander 400 HO	BTX20L-BS

# POWERSPORT - ATV

ENGINE	YEAR	MODEL	JIS Battery Type	ENGINE	YEAR	MODEL	JIS Battery Type	ENGINE	YEAR	MODEL	JIS Battery Type
<b>CAN-AM (Cont.)</b>				<b>HONDA (Cont.)</b>				<b>HONDA (Cont.)</b>			
400cc	2010-08	Outlander 400 HO EFI .....	BTX20L-BS	650cc	2005-04	TRX650FGA FourTrax Rincon GPScope .....	BTX20L-BS	420cc	2013-09	TRX420FPM Rancher 4x4 w/ Power Steering .....	BTX14-BS
	2010-08	Outlander 400 HO EFI XT .....	BTX20L-BS	500cc	2014-11	TRX500FA FourTrax Foreman Rubicon .....	BTX14-BS		2013-07	TRX420TE FourTrax Rancher ES .....	BTX14-BS
	2008-07	Outlander 400 HO XT .....	BTX20L-BS		2009-01	TRX500FA FourTrax Foreman Rubicon .....	BTX14-BS		2014	TRX420TE1 FourTrax Rancher ES .....	BTX14-BS
	2014-11	Outlander Max 400 EFI .....	BTX20L-BS		2013-11	TRX500FE FourTrax Foreman 4x4 ES .....	BTZ16H		2013-07	TRX420TM FourTrax Rancher .....	BTX14-BS
	2008-07	Outlander Max 400 HO .....	BTX20L-BS		2009-05	TRX500FE FourTrax Foreman 4x4 ES .....	BTX14-BS		2014	TRX420TM1 FourTrax Rancher .....	BTX14-BS
	2010-08	Outlander Max 400 HO EFI .....	BTX20L-BS		2014	TRX500FE1 FourTrax Foreman 4x4 ES .....	BTZ16H	400cc	2008-99	TRX400EX Sportrax .....	BTX9-BS
	2010-08	Outlander Max 400 HO EFI XT .....	BTX20L-BS		2014	TRX500FE2 FourTrax Foreman 4x4 ES with EPS .....	BTZ16H		2007-04	TRX400FA FourTrax Rancher AT .....	BTX14-BS
	2008-07	Outlander Max 400 HO XT .....	BTX20L-BS		2008-04	TRX500FGA FourTrax Foreman Rubicon GPScope .....	BTX14-BS		2007-04	TRX400FGA FourTrax Rancher AT GPScope .....	BTX14-BS
250cc	2014-07	DS 250 .....	BTX12-BS		2013-11	TRX500FM FourTrax Foreman 4x4 .....	BTZ16H		2003-95	TRX400FW Foreman 4x4 .....	BTX14-BS
200cc	2007	Rally 200 .....	B14A-A2		2009-05	TRX500FM FourTrax Foreman 4x4 .....	BTX14-BS		2014-12	TRX400X .....	BTX9-BS
90cc	2014-07	DS 90 .....	BTX4L-BS		2014	TRX500FM1 FourTrax Foreman 4x4 .....	BTZ16H		2009	TRX400X .....	BTX9-BS
	2014-08	DS 90 X .....	BTX4L-BS		2014	TRX500FM2 FourTrax Foreman 4x4 with EPS .....	BTZ16H	350cc	2006-00	TRX350FE FourTrax Rancher 4x4 ES .....	BTX14-BS
	2014-13	DS 70 .....	BTX4L-BS		2012-11	TRX500FPA FourTrax Foreman 4x4 AT w/ Power Steering .....	BTX14-BS		2006-00	TRX350FM FourTrax Rancher 4X4 .....	BTX14-BS
	2011-08	DS 70 .....	BTX4L-BS		2009	TRX500FPA FourTrax Foreman 4x4 AT w/ Power Steering .....	BTX14-BS		2006-00	TRX350TE FourTrax Rancher ES .....	BTX14-BS
	2007	DS 50 .....	BTX4L-BS		2014-11	TRX500FPA FourTrax Foreman Rubicon with EPS .....	BTX14-BS		2006-00	TRX350TM FourTrax Rancher .....	BTX14-BS
<b>CANNONDALE</b>					2013-11	TRX500FPE FourTrax Foreman 4x4 ES w/ Power Steering .....	BTZ16H		2009-02	TRX250TE FourTrax Recon ES .....	BTX12-BS
440cc	2003-02	Blaze 440 .....	BTX9-BS		2009-07	TRX500FPE FourTrax Foreman 4x4 ES w/ Power Steering .....	BTX14-BS		2014-11	TRX250TM FourTrax Recon .....	BTX12-BS
	2003-02	Cannibal 440 .....	BTX9-BS		2013-11	TRX500FPM FourTrax Foreman 4x4 w/ Power Steering .....	BTZ16H		2009-97	TRX250TM FourTrax Recon .....	BTX12-BS
	2003	Glamis 440 .....	BTX9-BS		2009-08	TRX500FPM FourTrax Foreman 4x4 w/ Power Steering .....	BTX14-BS		2014-11	TRX250X .....	BTX9-BS
	2003-02	Moto 440 .....	BTX9-BS		2006-05	TRX500TM FourTrax Foreman .....	BTX14-BS		2009	TRX250X .....	BTX9-BS
	2003-02	Speed 440 .....	BTX9-BS		2014-12	TRX450ER Electric Start .....	BTZ7S	200cc	1997-95	TRX200D FourTrax Type II .....	BTX12-BS
400cc	2001	FX400 .....	BTX9-BS		2004-98	TRX450FE FourTrax Foreman ES .....	BTX14-BS	90cc	2006	TRX90 Sportrax .....	BTX5L-BS
<b>E-TON</b>					2004-98	TRX450FM FourTrax Foreman S .....	BTX14-BS		2008-07	TRX90EX Sportrax .....	BTX5L-BS
250cc	2011-05	Vector 250R .....	BTX12-BS		2009-04	TRX450R .....	BTZ7S	<b>HYOSUNG</b>			
150cc	2011-05	Viper 150R .....	BTX9-BS		2014-09	TRX420FA Rancher AT .....	BTX14-BS	450cc	2010-08	TE450S .....	BTX9-BS
	2001-00	Yukon .....	BTX9-BS		2014	TRX420FA1 FourTrax Rancher 4x4 Auto DCT .....	BTZ16H	<b>JOHN DEERE</b>			
	2011	Yukon CXL 150 .....	BTX9-BS		2014	TRX420FA2 FourTrax Rancher 4x4 Auto DCT with EPS .....	BTZ16H	650cc	2006	Buck 650 Auto .....	B16CL-B
	2010-02	Yukon II CXL 150 .....	BTX9-BS		2013-07	TRX420FE FourTrax Rancher 4X4 ES .....	BTX14-BS		2006	Buck 650 EX Auto .....	B16CL-B
	2002-01	YXL 150 .....	BTX9-BS		2014	TRX420FE1 FourTrax Rancher 4x4 ES .....	BTX14-BS		2006	Buck 650 EXT Auto .....	B16CL-B
90cc	2001	AXL 90 .....	BTX4L-BS		2013-07	TRX420FM FourTrax Rancher 4X4 .....	BTX14-BS		2005-04	Trail Buck 650 .....	B16CL-B
	2001-99	DXL 90 .....	BTX4L-BS		2014	TRX420FM1 FourTrax Rancher 4x4 .....	BTX14-BS		2005-04	Trail Buck 650 EX .....	B16CL-B
	2002-00	Sierra 90 .....	BTX5L-BS		2014	TRX420FM2 FourTrax Rancher 4x4 .....	BTX14-BS		2006-04	Buck 500 .....	B16CL-B
	2001-99	Thunder 90 .....	BTX5L-BS		2014	TRX420FM3 FourTrax Rancher 4x4 .....	BTX14-BS		2006-05	Buck 500 Auto .....	B16CL-B
	2001-00	TXL 90 .....	BTX4L-BS		2013-07	TRX420FPE FourTrax Rancher 4X4 ES .....	BTX14-BS		2005-04	Buck 500 EX .....	B16CL-B
	2007-02	Viper 90 .....	BTX5L-BS		2014	TRX420FPE1 FourTrax Rancher 4x4 ES with EPS .....	BTZ16H		2005-04	Buck 500 EXT .....	B16CL-B
	2013	Viper 90 Silver Series .....	BTX5L-BS		2014	TRX420FPE2 FourTrax Rancher 4x4 ES with EPS .....	BTZ16H		2005-04	Trail Buck 500 .....	B16CL-B
	2011-09	Viper 90 Silver Series .....	BTX5L-BS		2014	TRX420FPM1 FourTrax Rancher 4x4 .....	BTX14-BS	<b>KASEA</b>			
	2005	Viper 90R (Reverse) .....	BTX5L-BS		2014	TRX420FPM2 FourTrax Rancher 4x4 .....	BTX14-BS	250cc	2005-03	Skyhawk 250 .....	BTX7A-BS
	2011-06	Viper 90R 4-Stroke .....	BTX5L-BS		2013-07	TRX420FPM3 FourTrax Rancher 4x4 .....	BTX14-BS	170cc	2005-03	Skyhawk 170 .....	BTX7A-BS
	2013	Viper 90R Silver Series .....	BTX5L-BS		2014	TRX420FPM4 FourTrax Rancher 4x4 .....	BTX14-BS	90cc	2005-02	Skyhawk 90 .....	BTZ7S
	2011-09	Viper 90R Silver Series .....	BTX5L-BS		2014	TRX420FPM5 FourTrax Rancher 4x4 .....	BTX14-BS	<b>KAWASAKI</b>			
70cc	2005	Viper 70 .....	BTX5L-BS		2014	TRX420FPM6 FourTrax Rancher 4x4 .....	BTX14-BS	750cc	2014-05	KVF750 Brute Force 4x4i .....	BTX14-BS
	2011-06	Viper 70 4-Stroke .....	BTX5L-BS		2014	TRX420FPM7 FourTrax Rancher 4x4 with EPS .....	BTX14-BS		2014-12	KVF750 Brute Force 4x4i EPS .....	BTX14-BS
	2011-09	Viper 70 Silver Series .....	BTX5L-BS		2014-09	TRX420FPA Rancher AT 4x4 w/ Power Steering .....	BTX14-BS	700cc	2009-04	KVF700 .....	BTX14-BS
	2007-06	Viper 70M 4-Stroke .....	BTX5L-BS		2013-09	TRX420FPE Rancher ES 4x4 w/ Power Steering .....	BTX14-BS		2006-04	KVF700 Prairie 4x4 .....	BTX14-BS
50cc	2001	AXL 50 .....	BTX4L-BS					650cc	2013	KVF650 Brute Force 4x4 .....	BTX14-BS
	2001-99	Lightning 50 .....	BTX5L-BS						2011-05	KVF650 Brute Force 4x4 .....	BTX14-BS
	2001-00	TXL 50 .....	BTX4L-BS								
	2004-02	Viper 50 .....	BTX5L-BS								
	2005	Viper 50M (Mini) .....	BTX5L-BS								
40cc	2001-00	Rascal 40 .....	BTX4L-BS								
	2005	Viper 40E (Electric) .....	BTX4L-BS								
	2004	Viper Jr. .....	BTX5L-BS								
	2003-02	Viper Jr. .....	BTX4L-BS								
<b>HONDA</b>											
700cc	2009-08	TRX700XX .....	BTX9-BS								
680cc	2014-06	TRX680FA FourTrax Rincon .....	BTX20L-BS								
	2009-06	TRX680FGA FourTrax Rincon GPScope .....	BTX20L-BS								
650cc	2005-03	TRX650FA FourTrax Rincon .....	BTX20L-BS								

# POWERSPORT - ATV

ENGINE	YEAR	MODEL	JIS Battery Type	ENGINE	YEAR	MODEL	JIS Battery Type	ENGINE	YEAR	MODEL	JIS Battery Type
<b>KAWASAKI (Cont.)</b>				<b>POLARIS (Cont.)</b>				<b>POLARIS (Cont.)</b>			
650cc	2013-11	KVF650 Brute Force 4x4i	BTX14-BS	800cc	2007	Sportsman 800 EFI X2 Deluxe	BTX30L	330cc	2011-03	Trail Boss 330	BTX14AH-BS
	2009-06	KVF650 Brute Force 4x4i	BTX14-BS		2008	Sportsman 800 HO EFI Military	BTX30L	325cc	2002-00	Magnum 325 2x4	B14A-A2
	2003-02	KVF650 Prairie 4x4	BTX14-BS	600cc	2005-03	Sportsman 600	B30L-B		2002-00	Magnum 325 4x4	B14A-A2
450cc	2014-08	KFX450R	BTX7L-BS	570cc	2014	Sportsman 570	BTX14AH-BS		2002-99	Trail Boss 325	B14A-A2
400cc	2006-03	KFX400	BTX9-BS		2014	Sportsman 570 EPS	BTX14AH-BS	300cc	2002-00	Xpedition 325	B14A-A2
	1999-95	KLF400 Bayou 4x4	B16CL-B		2014	Sportsman 570 Touring	BTX14AH-BS		1995	300 2x4	B14A-A2
	2002-98	KVF400 Prairie 2x4	B14A-A2		2014	Sportsman 570	BTX14AH-BS		2010-06	Hawkeye 2x4	B14-B2
	2002-97	KVF400 Prairie 4x4	B14A-A2	550cc	2014-12	Sportsman 550 EPS	BTX14AH-BS		2007-06	Hawkeye 4x4	B14-B2
360cc	2009-03	KVF360 Prairie 2x4	B14A-A2		2014-11	Sportsman 550 EPS Browning LE	BTX14AH-BS	250cc	2010-08	Sportsman 300	B14-B2
	2013-03	KVF360 Prairie 4x4	B14A-A2		2012	Sportsman 550 EPS Orange	BTX14AH-BS		2006-95	Trail Blazer 250	B14A-A2
300cc	2003-01	KEF300 Lakota Sport	B14A-A2		2013	Sportsman 550 EPS Stealth Black	BTX14AH-BS		1999-95	Trail Boss 250	B14A-A2
	2000-95	KEF300 Lakota Utility	B14A-A2		2011-07	Outlaw 525 IRS	BTX9-BS	200cc	2002-00	Xplorer 250 4x4	B14A-A2
	2004-95	KLF300 Bayou 2x4	B14A-A2		2010-08	Outlaw 525 S	BTX9-BS		2014-05	Phoenix 200	BTX12-BS
	2004-95	KLF300 Bayou 4x4	B14A-A2		2005-04	ATP 500	B14A-A2		2007-06	Sawtooth	BTX12-BS
	2014-12	KVF300 Brute Force	BTX12-BS		1999-98	Big Boss 500 6x6	B14A-A2	90cc	2014-07	Outlaw 90	BTX5L-BS
	2002-99	KVF300 Prairie 2x4	B14A-A2		2002	Magnum 500 2x4	B14A-A2		2006-03	Predator 90	BTX5L-BS
	2002-99	KVF300 Prairie 4x4	B14A-A2		2003-99	Magnum 500 4x4	B14A-A2		2002-01	Scrambler 90	BTX4L-BS
250cc	2011-03	KLF250 Bayou	B10A-A2		2007-06	Outlaw 500	BTX9-BS		2014-03	Sportsman 90	BTX5L-BS
	2005-03	KLF250 Bayou (Can.)	B14-A2	525cc	2007-06	Outlaw 500	BTX9-BS		2002-01	Sportsman 90	BTX4L-BS
220cc	2002-95	KLF220 Bayou	B10A-A2		2007-03	Predator 500	BTX9-BS	50cc	2014-08	Outlaw 50	BTX5L-BS
	2002-95	KLF220 Bayou	B14A-A2	500cc	2002-01	Scrambler 500 2x4	B14A-A2		2007-04	Predator 50	BTX5L-BS
90cc	2014-07	KFX90	BTX5L-BS		2012-97	Scrambler 500 4x4	B14A-A2		2003	Scrambler 50	BTX5L-BS
80cc	2006-03	KFX80	BTX5L-BS		2009-06	Sportsman 500 EFI	BTX30L		2002-01	Scrambler 50	BTX4L-BS
50cc	2014-13	KFX50	BTX5L-BS		2007	Sportsman 500 EFI Deluxe	BTX30L	<b>SUZUKI</b>			
	2009-07	KFX50	BTX5L-BS		2010-08	Sportsman 500 EFI Touring	BTX30L	750cc	2014-11	LT-A750 KingQuad AXi Power Steering	BTX20CH-BS
<b>KTM</b>					2009-06	Sportsman 500 EFI X2	BTX30L		2014-11	LT-A750X KingQuad AXi 4x4	BTX20CH-BS
525cc	2010-08	525 XC	BTX5L-BS		2007	Sportsman 500 EFI X2 Deluxe	BTX30L		2009-08	LT-A750X KingQuad AXi 4x4	BTX20CH-BS
505cc	2010-09	505SX	BTX5L-BS		2013-08	Sportsman 500 HO	B14A-A2	700cc	2007-05	LT-A700X KingQuad 4x4	BTX20CH-BS
450cc	2010-08	450 XC	BTX5L-BS		2006-01	Sportsman 500 HO	B14A-A2		2005-04	LT-V700F Twin Peaks 700 4x4	BTX14
	2010-09	450SX	BTX5L-BS		2012	Sportsman 500 HO	B14A-A2	500cc	2014-11	LT-A500 KingQuad AXi	BTX20CH-BS
<b>KYMCO</b>					2001	Polaris Pursuite LE	B14A-A2		2014-11	LT-A500 KingQuad AXi Power Steering	BTX20CH-BS
700cc	2014-13	MXU700i 4x4 IRS	BTX20L-BS		2013-10	Sportsman 500 HO Touring	B14A-A2		2009	LT-A500 KingQuad AXi Power Steering	BTX20CH-BS
	2014-13	MXU700i 4x4 IRS LE	BTX20L-BS		2001	Worker 500	B14A-A2		2001-00	LT-A500F QuadMaster	BTX16-BS-1
500cc	2009-06	MXU500	BTX20L-BS		1999	Worker 500	B14A-A2		2007-02	LT-A500F Vinson 500 4x4 Auto	BTX20CH-BS
	2014-12	MXU500 4x4 IRS	BTX20L-BS	455cc	2002-99	Diesel (455cc) (Primary)	B30CL-B		2002-98	LT-F500F QuadRunner 4x4	BTX16-BS-1
	2011-10	MXU500 IRS	BTX20L-BS		2002-99	Diesel (455cc) (Secondary)	B14A-A2		2007-04	LT-F500F Vinson 500 4x4	BTX20CH-BS
	2014-12	MXU500i 4x4 IRS	BTX20L-BS	425cc	2010-08	Outlaw 450 MXR	BTX9-BS		2003	LT-F500F Vinson 500 4x4	B16-B
	2014-12	MXU500i 4x4 IRS LE	BTX20L-BS		1998-95	Magnum 425 2x4	B14A-A2	450cc	2010-07	LT-A450X KingQuad AXi 4x4	BTX14-BS
450cc	2014-12	Maxxer 450i 4x4	BTX20L-BS		1997-96	Magnum 425 6x6	B14A-A2		2009-06	LT-R450 QuadRacer	BTX7A-BS
375cc	2011-10	Maxxer 375 4x4 IRS	B14A-A2		2002-00	Xpedition 425	B14A-A2	400cc	2007-02	LT-A400 Eiger 2x4 Auto	BTX14-BS
	2011-10	MXU375 IRS	B14-A2		1995	400L 2x4	B14A-A2		2007-02	LT-A400F Eiger 4x4 Auto	BTX14-BS
	2011	MXU375 IRS LE	B14-A2		1997-95	Big Boss 400L 6x6	B14A-A2		2010-08	LT-A400F KingQuad AS	BTX14-BS
300cc	2008	Maxxer 300	BTX12-BS		2002-00	Scrambler 400 2x4	B14A-A2		2014-11	LT-A400F KingQuad ASi	BTX14-BS
	2014-06	Mongoose 300	BTX12-BS		2002-95	Scrambler 400 4x4	B14A-A2		2007-02	LT-F400 Eiger 2x4	BTX14-BS
	2014-05	MXU300	BTX12-BS		1999-95	Sport 400L	B14A-A2		2007-02	LT-F400F Eiger 4x4	BTX14-BS
250cc	2008	Maxxer 250	BTX12-BS		2005-01	Sportsman 400	B14A-A2		2010-08	LT-F400F KingQuad FS	BTX14-BS
	2009-04	Mongoose 250	BTX12-BS		1996-95	Sportsman 400 4x4	B14A-A2		2007-02	LT-F400F KingQuad FS	BTX14-BS
	2009-04	MXU250	BTX12-BS		2014-07	Sportsman 400 HO	B14A-A2		2010-08	LT-F400F KingQuad FS	BTX14-BS
150cc	2014-05	MXU150	BTX9-BS		2013	Sportsman 400 HO South Edition	B14A-A2		2014-11	LT-F400F KingQuad FSi	BTX14-BS
90cc	2010-04	Mongoose 90	BTX5L-BS		1997	Sportsman 400L	B14A-A2		2013-12	LT-Z400 QuadSport Z	BTX9-BS
	2014-12	Mongoose 90 R	BTX5L-BS		2003	Trail Blazer 400	B14A-A2		2009-03	LT-Z400 QuadSport Z	BTX9-BS
70cc	2010-07	Mongoose 70	BTX5L-BS		2001-95	Xplorer 400 4x4	B14A-A2		2012	LT-Z400 QuadSport Z LE	BTX9-BS
50cc	2008	Maxxer 50	BTX5L-BS		2002	Xplorer 400L	B14A-A2		2002-99	LT-F300F KingQuad 4x4	B14A-A2
	2011	Mongoose 50	BTX5L-BS		1997-96	Xpress 400L	B14A-A2				
	2009-04	Mongoose 50	BTX5L-BS		2000-98	Sportsman 335	B14A-A2				
<b>POLARIS</b>					1999	Worker 335	B14A-A2				
850cc	2014-13	Scrambler 850 XP HO	BTX20HL-BS	335cc	2005-03	Magnum 330 2x4	BTX14AH-BS	300cc			
	2014-13	Scrambler 850 XP HO EPS LE	BTX20HL-BS		2006-03	Magnum 330 4x4	BTX14AH-BS				
800cc	2014-12	Sportsman 800 6x6 Big Boss	BTX30L		2013-08	Trail Blazer 330	B14A-A2				
	2014	Sportsman 800 EFI	BTX20HL-BS		2013-12	Trail Boss 330	B14A-A2				
	2013-05	Sportsman 800 EFI	BTX30L								
	2011-09	Sportsman 800 EFI 6x6 Big Boss	BTX30L								
	2007	Sportsman 800 EFI Deluxe	BTX30L								
	2010-08	Sportsman 800 EFI HO	BTX30L								
	2009-08	Sportsman 800 EFI Touring	BTX30L								
	2009-07	Sportsman 800 EFI X2	BTX30L								

# POWERSPORT - ATV - Personal Watercraft

ENGINE	YEAR	MODEL	JIS Battery Type	ENGINE	YEAR	MODEL	JIS Battery Type	ENGINE	YEAR	MODEL	JIS Battery Type	
<b>SUZUKI (Cont.)</b>				<b>YAMAHA (Cont.)</b>				<b>Personal Watercraft</b>				
300cc	2002-99	LT-F300F KingQuad 4x4 (Canada, Optional) .....	B50-N18A-A	400cc	2004-00	YFM400 Big Bear 2x4 .....	BTX20L-BS	<b>HONDA</b>				
	1998-95	LT-F4WDX King Quad 300 .....	B14A-A2		2006-00	YFM400 Big Bear 4x4 .....	BTX20L-BS	1500cc	2009	AquaTrax F-15 .....	BTX20L-BS	
	1998-95	LT-F4WDX King Quad 300 (Canada, Optional) .....	B50-N18A-A		2012-07	YFM400 Big Bear IRS 4x4 .....	BTX20L-BS		2009-08	AquaTrax F-15X .....	BTX20L-BS	
250cc	1998-95	LT-4WD QuadRunner 250 .....	B14A-A2		2008-07	YFM400 Grizzly 4x4 Auto .....	BTX14AH-BS		2008	AquaTrax F-15X GPScape .....	BTX20L-BS	
	1998-95	LT-4WD QuadRunner 250 (Optional) .....	B50-N18A-A		2004-03	YFM400A Kodiak .....	BTX14AH-BS	1200cc	2007-02	AquaTrax F-12 .....	BTX20L-BS	
	1998-96	LT-4WDX King Quad 250 .....	B14A-A2		2002-00	YFM400A Kodiak .....	BTX20L-BS		2007-02	AquaTrax F-12X .....	BTX20L-BS	
	1998-96	LT-4WDX King Quad 250 (Canada, Optional) .....	B50-N18A-A		2006-03	YFM400F Kodiak 4x4 .....	BTX14AH-BS		2007-05	AquaTrax F-12X GPScape .....	BTX20L-BS	
	2014-12	LT-F250 Ozark .....	BTX12-BS	350cc	2002-96	YFM400F Kodiak 4x4 .....	BTX20L-BS		2006-04	AquaTrax R-12 .....	BTX20L-BS	
	2009-02	LT-F250 Ozark .....	BTX12-BS		1995	YFM400F Kodiak 4x4 .....	B14-A2	<b>KAWASAKI</b>				
	2002-95	LT-F250 QuadRunner .....	B14A-A2		2006-04	YFM350 Bruin Auto 2x4 .....	BTX14AH-BS	1500cc	2010-09	JT1500 STX .....	BTX20L-BS	
	2002-95	LT-F250 QuadRunner (Optional) .....	B50-N18A-A		2014-07	YFM350 Grizzly 4x4 Auto .....	BTX14AH-BS		2014-04	JT1500 STX-15F .....	BTX20L-BS	
	2002-99	LT-F250F QuadRunner 4x4 .....	B14A-A2		2012-07	YFM350 Grizzly Auto .....	BTX14AH-BS		2008-07	JT1500 Ultra 250X .....	BTX20L-BS	
	2002-99	LT-F250F QuadRunner 4x4 (Canada, Optional) .....	B50-N18A-A		2012-07	YFM350 Grizzly IRS 4x4 Auto .....	BTX14AH-BS		2010-09	JT1500 Ultra 260LX .....	BTX20L-BS	
	2009-04	LT-Z250 QuadSport Z .....	BTX9-BS		2013-04	YFM350 Raptor .....	BTZ10S		2010-09	JT1500 Ultra 260X .....	BTX20L-BS	
160cc	2004-03	LT160 .....	B9A-A		2009-06	YFM350 Wolverine ...	BTX14AH-BS		2013-11	JT1500 Ultra 300 LX .....	BTX20L-BS	
	2004-03	LT-F160 QuadRunner .....	B9A-A		1995	YFM350ER Moto-4 .....	B14A-A2		2013-11	JT1500 Ultra 300 X .....	BTX20L-BS	
	2001-95	LT-F160 QuadRunner .....	B9A-A		2005-96	YFM350F Wolverine 4x4 .....	B12C-A		2014	JT1500 Ultra 310LX .....	BTX20L-BS	
90cc	2009-07	LT-Z90 QuadSport .....	BTX5L-BS		1995	YFM350F Wolverine 4x4 .....	B14-A2		2014	JT1500 Ultra 310R .....	BTX20L-BS	
80cc	2006-95	LT80 QuadSport .....	BTX5L-BS		2006-04	YFM350F Bruin Auto 4x4 .....	BTX14AH-BS		2014	JT1500 Ultra 310X .....	BTX20L-BS	
50cc	2009-06	LT-Z50 QuadSport .....	BTX5L-BS		1998-95	YFM350FW Big Bear 4x4 .....	B14A-A2		2014	JT1500 Ultra 310X SE .....	BTX20L-BS	
<b>YAMAHA</b>					1999	YFM350FW Big Bear 4x4 (YFM350FWBL) .....	B14A-A2	1200cc	2003-96	JH1100 1100ZXi .....	BTX20L-BS	
700cc	2014-07	YFM700 Grizzly FI 4x4 Auto .....	BTX20L-BS		1999	YFM350FW Big Bear 4x4 (YFM350FWXL) .....	B12C-A		2004-01	JH1100 Ultra 130 .....	BTX20L-BS	
	2014-07	YFM700 Grizzly FI 4x4 Auto EPS .....	BTX20L-BS		1999-96	YFM350U Big Bear 2x4 .....	B14A-A2		1997-95	JH900 900ZXi .....	BTX20L-BS	
	2014-09	YFM700 Grizzly FI 4x4 Auto EPS SE .....	BTX20L-BS		2004-95	YFM350X Warrior .....	B12C-A		2002-01	JT900 900STS .....	BTX20L-BS	
	2014-13	YFM700 Raptor .....	BT9B-4		2014-12	YFM300 Grizzly Automatic .....	BTX12-BS		2006-97	JT900 900STX .....	BTX20L-BS	
	2014-11	YFM700R Raptor .....	BT9B-4		1998-95	YFB250 Timberwolf 2x4 .....	B12C-A		2011-03	JS800 800 SX-R .....	BTX20L-BS	
	2009-06	YFM700R Raptor .....	BT9B-4		2000-95	YFB250FW Timberwolf 4x4 .....	B12C-A		1997-95	JH750 750S5 .....	B16CL-B	
	2007	YFM700R Raptor GYTR Edition .....	BT9B-4		2004-99	YFM250 Bear Tracker .....	B14A-A2		1997-95	JH750 750ZXi .....	B16CL-B	
	2014-07	YFM700R Raptor SE .....	BT9B-4		2009-07	YFM250 Big Bear .....	B14A-A2		1997-95	JH750 750ZXi .....	BTX20L-BS	
660cc	2008-02	YFM660F Grizzly 4x4 .....	BTX20L-BS		2006-05	YFM250 Bruin .....	B14A-A2		1997-95	JH750 Super Sport XI .....	B16CL-B	
	2005-01	YFM660R Raptor .....	BTX14-BS		2013-08	YFM250 Raptor .....	BTZ7S		1999-98	JH750 Xi Sport .....	B16CL-B	
600cc	2001-98	YFM600FW Grizzly 4x4 .....	BTX20L-BS		2008	YFM250 Raptor SE .....	BTZ7S		1995	JS750 750SX .....	B16CL-B	
	2014-09	YFM550 Grizzly FI 4x4 Auto .....	BTX20L-BS		2008	YFM250 Raptor SE Custom .....	BTZ7S		1996-95	JS750 750SXi .....	BTX20L-BS	
	2014-09	YFM550 Grizzly FI 4x4 Auto EPS .....	BTX20L-BS	125cc	2011	YFM250R Raptor .....	BTZ7S		2002-98	JS750 SXi Pro .....	BTX20L-BS	
	2014-11	YFM450 Grizzly 4x4 Auto .....	BTX20L-BS		2004-95	YFA-1 Breeze125 .....	B12C-A		1998	JT750 750STX .....	BTX20L-BS	
	2008-07	YFM450 Grizzly 4x4 Auto .....	BTX20L-BS		2013-04	YFM125 Grizzly .....	B12C-A	650cc	1995	JT750 ST .....	BTX20L-BS	
	2014-11	YFM450 Grizzly 4x4 Auto EPS .....	BTX20L-BS		2013-11	YFM125 Raptor .....	BTZ7S		1995	JT750 STS .....	B16CL-B	
	2010-09	YFM450 Grizzly 4x4 Auto IRS .....	BTX20L-BS		2013-09	YFM90 Raptor .....	BTX5L-BS		1996-95	JF650 TS .....	B16CL-B	
	2006-03	YFM450F Kodiak Auto 4x4 .....	BTX20L-BS	90cc	2001-95	YFM80 Badger .....	12N7D-3B		1995	JL650 X2 .....	B16CL-B	
	2010-06	YFM450FX Wolverine 4x4 .....	BTX20L-BS	80cc	2008-05	YFM80 Grizzly .....	12N7D-3B		1995	JL650 SC .....	B16CL-B	
	2013-12	YFZ450 .....	BT7B-4		2008-02	YFM80W Raptor .....	12N7D-3B		1995	JS550 550SX .....	B16CL-B	
	2009-04	YFZ450 .....	BT7B-4	50cc	2008-04	YFM50 Raptor .....	12N7D-3B	<b>POLARIS</b>				
	2007-06	YFZ450 Bill Balance Edition .....	BT7B-4					1200cc	2004-03	MSX 140 .....	B16CL-B	
	2008-07	YFZ450 SE .....	BT7B-4						2001-00	Pro 1200 .....	B16CL-B	
	2014-09	YFZ450R .....	BTZ7S						2001-00	Virage TX .....	B16CL-B	
	2014-09	YFZ450R SE .....	BTZ7S						2002-01	Virage TXi .....	B16CL-B	
	2011-10	YFZ450X .....	BTZ7S						2002-99	Genesis .....	B16CL-B	
	2010	YFZ450X Bill Balance .....	BTZ7S						2000-99	Genesis FFI .....	B16CL-B	
	2011	YFZ450X SE .....	BTZ7S						2004-02	Genesis I .....	B16CL-B	
									1997	SL 1050 .....	B16CL-B	
									1999-96	SLTX .....	B16CL-B	
									1999	SLTX-B .....	B16CL-B	
									2001-99	SLX .....	B16CL-B	
									1998	SLXH .....	B16CL-B	
									1997-96	SL 900 .....	B16CL-B	
									800cc	2004-02	Octane .....	B16CL-B
										2004-00	Virage .....	B16CL-B
										2004-02	Virage I .....	B16CL-B
										2000-99	Pro 785 .....	B16CL-B
										1998-97	SLX Pro 785 .....	B16CL-B
										1997-96	SL 780 .....	B16CL-B
										1997-96	SLT 780 .....	B16CL-B
										1996-95	SLX 780 .....	B16CL-B

# POWERSPORT - Personal Watercraft - Snowmobile

ENGINE	YEAR	MODEL	JIS Battery Type	ENGINE	YEAR	MODEL	JIS Battery Type	ENGINE	YEAR	MODEL	JIS Battery Type
<b>POLARIS (Cont.)</b>				<b>YAMAHA (Cont.)</b>				<b>Snowmobile</b>			
750cc	2004	MSX 110	B16CL-B	1200cc	2005-01	XA1200A WaveRunner	B16CL-B	<b>ARCTIC CAT</b>			
	2004	MSX 150	B16CL-B		1998	XL1200 WaveRunner	B16CL-B	1100cc	2014-09	Bearcat Z1 XT	BTX20H-BS
	1995	SL 750	B16CL-B			XL1200	B16CL-B		2014-12	Bearcat Z1 XT GS	BTX20H-BS
	1995	SLT 750	B16CL-B		1100cc	FX1100 WaveRunner	B16CL-B		2014-12	Bearcat Z1 XT Limited	BTX20H-BS
700cc	2002	Freedom	B16CL-B		2006-04	FX1100 WaveRunner	B16CL-B		2008-07	Jaguar Z1 1100 EFI	BTX20H-BS
	1997-96	Hurricane	B16CL-B			FX HO	B16CL-B		2008	Jaguar Z1 1100 EFI Sno Pro	BTX20H-BS
	1997-96	SL 700	B16CL-B		2007	FX1100 WaveRunner	B16CL-B		2007	Jaguar Z1 Early Build	BTX20H-BS
	1997	SL 700 Deluxe	B16CL-B			FX HO	B16CL-B		2013-12	ProClimb M 1100	BTX20H-BS
	2001-98	SLH	B16CL-B		2008-04	FX1100A WaveRunner	B16CL-B		2012	ProClimb M 1100	BTX20H-BS
	1997-96	SLT 700	B16CL-B			FX Cruiser HO	B16CL-B		2012	ProClimb M 1100	BTX20H-BS
	1999-98	SLTH	B16CL-B		2006	FX1100B WaveRunner	B16CL-B		2012	ProClimb M 1100	BTX20H-BS
650cc	1995	SL 650	B16CL-B			FX Cruiser HO 50th Ann.	B16CL-B		2012	ProClimb M 1100	BTX20H-BS
	1995	SL 650 Std	B16CL-B		1996-95	RA1100 WaveRaider	B16CL-B		2012	ProClimb M 1100	BTX20H-BS
<b>SEA-DOO</b>						1100	B16CL-B		2012	ProClimb M 1100	BTX20H-BS
1550cc	2014-11	GTI Limited 155	B30CL-B		2006-05	VX1100 WaveRunner	B16CL-B		2013-12	ProClimb M 1100	BTX20H-BS
	2014-09	GTI SE 155	B30CL-B			1100 Sport	B16CL-B		2013-12	ProClimb M 1100	BTX20H-BS
	2014-10	GTX 155	B30CL-B		2010-07	VX1100 WaveRunner	B16CL-B		2013-12	ProClimb M 1100	BTX20H-BS
1500cc	2014-12	GTR 215	B30CL-B			VX	B16CL-B		2013-12	ProClimb M 1100	BTX20H-BS
	2006-05	RXP	B30CL-B		2006-05	VX1100A WaveRunner	B16CL-B		2013-12	ProClimb M 1100	BTX20H-BS
	2011-10	RXP X 255	B30CL-B			1100 Deluxe	B16CL-B		2013-12	ProClimb M 1100	BTX20H-BS
	2009	RXT 215	B30CL-B		2013-07	VX1100A WaveRunner	B16CL-B		2012	ProClimb M 1100	BTX20H-BS
	2011	RXT 260	B30CL-B			VX Cruiser	B16CL-B		2013-12	ProClimb M 1100	BTX20H-BS
	2009	RXT IS 255	B30CL-B		2013-07	VX1100B WaveRunner	B16CL-B		2012	ProClimb M 1100	BTX20H-BS
	2011-10	RXT IS 260	B30CL-B			VX Deluxe	B16CL-B		2013-12	ProClimb M 1100	BTX20H-BS
	2009	RXT X 255	B30CL-B		2014-07	VX1100C WaveRunner	B16CL-B		2013-12	ProClimb M 1100	BTX20H-BS
	2011-10	RXT X 260	B30CL-B			VX Sport	B16CL-B		2013-12	ProClimb M 1100	BTX20H-BS
	2011-10	Wake 155	B30CL-B		1997-96	WVT1100	B16CL-B		2013-12	ProClimb M 1100	BTX20H-BS
	2011-10	Wake Pro 215	B30CL-B			WaveVenture 1100	B16CL-B		2013	ProClimb M 1100	BTX20H-BS
1300cc	2014-09	GTI 130	B30CL-B		1000cc	FX1000 FX140	B16CL-B		2013	ProClimb M 1100	BTX20H-BS
	2014-09	GTI SE 130	B30CL-B		2008-05	FX1000 WaveRunner	B16CL-B		2013-12	ProClimb M 1100	BTX20H-BS
	2014-11	GTS 130	B30CL-B			FX	B16CL-B		2013-12	ProClimb M 1100	BTX20H-BS
950cc	2005	3D RFI	B16CL-B		2004-02	FX1000A FX140 Cruiser	B16CL-B		2013-12	ProClimb M 1100	BTX20H-BS
947cc	2007-06	3D 947 DI	B16CL-B		2008-05	FX1000A WaveRunner	B16CL-B		2013-12	ProClimb M 1100	BTX20H-BS
<b>WET JET</b>						FX Cruiser	B16CL-B		2013-12	ProClimb M 1100	BTX20H-BS
700cc	1997-95	Kraze	B16-B		800cc	GP800 WaveRunner	B16CL-B		2013-12	ProClimb M 1100	BTX20H-BS
	1997-95	ZX	B16-B			GP800	B16CL-B		2012	ProClimb M 1100	BTX20H-BS
300cc	1997-95	Duo 300	B16-B		2005-01	GP800A WaveRunner	B16CL-B		2013-12	ProClimb M 1100	BTX20H-BS
<b>YAMAHA</b>						GP800R	B16CL-B		2013-12	ProClimb M 1100	BTX20H-BS
1800cc	2014-13	FA1800 WaveRunner	B16CL-B		2001-00	XA800 WaveRunner	B16CL-B		2013-12	ProClimb M 1100	BTX20H-BS
		FX SHO	B16CL-B			XL800	B16CL-B		2013-12	ProClimb M 1100	BTX20H-BS
	2014-13	FA1800A WaveRunner	B16CL-B		2004-02	XA800A WaveRunner	B16CL-B		2013-12	ProClimb M 1100	BTX20H-BS
		FX Cruiser SHO	B16CL-B			XLT800	B16CL-B		2013-12	ProClimb M 1100	BTX20H-BS
	2014-13	FB1800 WaveRunner	B16CL-B		760cc	GP760 WaveRunner	B16CL-B		2013-12	ProClimb M 1100	BTX20H-BS
		FX HO	B16CL-B			GP760	B16CL-B		2012	ProClimb M 1100	BTX20H-BS
	2012	FB1800 Waverunner	B16CL-B		1996	RA760 WaveRaider 760	B16CL-B		2013-12	ProClimb M 1100	BTX20H-BS
		FX HO	B16CL-B		1997-96	WB760 WaveBlaster	B16CL-B		2013-12	ProClimb M 1100	BTX20H-BS
	2014-13	FB1800A WaveRunner	B16CL-B			760	B16CL-B		2013	ProClimb M 1100	BTX20H-BS
		FX Cruiser HO	B16CL-B		1997	WVT760 WaveVenture	B16CL-B		2013	ProClimb M 1100	BTX20H-BS
	2012-08	FX1800 WaveRunner	B16CL-B			760	B16CL-B		2013	ProClimb M 1100	BTX20H-BS
		FX Cruiser SHO	B16CL-B		1999-98	XL760 WaveRunner	B16CL-B		2013	ProClimb M 1100	BTX20H-BS
	2012	FX1800 Waverunner	B16CL-B			XL760	B16CL-B		2013	ProClimb M 1100	BTX20H-BS
		FX Cruiser SHO	B16CL-B		700cc	FX700 FX-1	B16CL-B		2013-12	ProClimb M 1100	BTX20H-BS
	2012-08	FX1800 WaveRunner	B16CL-B			RA700 WaveRaider	B16CL-B		2013-12	ProClimb M 1100	BTX20H-BS
		FX SHO	B16CL-B		1995	RA700A WaveRaider	B16CL-B		2013-12	ProClimb M 1100	BTX20H-BS
	2011-09	FY1800 WaveRunner	B16CL-B			Deluxe	B16CL-B		2013-12	ProClimb M 1100	BTX20H-BS
		FX HO	B16CL-B		2014-95	SJ700 Super Jet	B16CL-B		2012	ProClimb M 1100	BTX20H-BS
	2011-09	FY1800A WaveRunner	B16CL-B		1996-95	WB700 WaveBlaster	B16CL-B		2012	ProClimb M 1100	BTX20H-BS
		FX Cruiser HO	B16CL-B		1997	WRA700 WaveRunner	B16CL-B		2013-12	ProClimb M 1100	BTX20H-BS
	2013-09	GX1800 WaveRunner	B16CL-B			III 700	B16CL-B		2013-12	ProClimb M 1100	BTX20H-BS
		FZR	B16CL-B		1995	WRA700 WaveRunner	B16CL-B		2013	ProClimb M 1100	BTX20H-BS
	2013-09	GX1800A WaveRunner	B16CL-B			III GP	B16CL-B		2013-12	ProClimb M 1100	BTX20H-BS
		FZS	B16CL-B		1998	WVT700 WaveVenture	B16CL-B		2013-12	ProClimb M 1100	BTX20H-BS
	2014-11	VX1800AK	B16CL-B			700	B16CL-B		2013-12	ProClimb M 1100	BTX20H-BS
		WaveRunner VXR	B16CL-B		1996-95	WVT700 WaveVenture	B16CL-B		2013-12	ProClimb M 1100	BTX20H-BS
	2014-11	VX1800K WaveRunner	B16CL-B			700	B16CL-B		2013-12	ProClimb M 1100	BTX20H-BS
		VXS	B16CL-B		2001-99	XL700 WaveRunner	B16CL-B		2012	ProClimb M 1100	BTX20H-BS
1300cc	2008-03	GP1300 WaveRunner	B16CL-B			XL700	B16CL-B		2013-12	ProClimb M 1100	BTX20H-BS
		GP1300R	B16CL-B		2004-02	XL700A WaveVenture	B16CL-B		2012	ProClimb M 1100	BTX20H-BS
1200cc	2002-97	GP1200 WaveRunner	B16CL-B			XL700	B16CL-B		2013-12	ProClimb M 1100	BTX20H-BS
		GP1200	B16CL-B		650cc	WRA650 WaveRunner	B16CL-B		2014-10	TZ1	BTX20H-BS
	2004-99	SV1200 WaveRunner	B16CL-B			III	B16CL-B		2014-10	TZ1 LXR	BTX20H-BS
		SUV1200	B16CL-B		1995	WRB650 WaveRunner	B16CL-B		2009	TZ1 Park	BTX20H-BS
	2000-99	XA1200 WaveRunner	B16CL-B			VXR	B16CL-B		2010-08	TZ1 Touring	BTX20H-BS
		XL12 LTD	B16CL-B						2010-08	TZ1 Touring LXR	BTX20H-BS
	2009	XA1200 WaveRunner	B16CL-B								

# POWERSPORT - Snowmobile

ENGINE	YEAR	MODEL	JIS Battery Type	ENGINE	YEAR	MODEL	JIS Battery Type	ENGINE	YEAR	MODEL	JIS Battery Type
<b>ARCTIC CAT (Cont.)</b>				<b>ARCTIC CAT (Cont.)</b>				<b>ARCTIC CAT (Cont.)</b>			
1100cc	2014-09	TZ1 Turbo LXR	BTX20H-BS	800cc	2004-03	Mountain Cat 800		660cc	2007-06	T660 Turbo	
	2010-09	TZ1 Turbo LXR LE	BTX20H-BS			EFI 151	B50N-18L-LM			Touring LE	BTX24HL-BS
	2013	TZ1 Turbo Touring			2004	Mountain Cat 800			2007-06	T660 Turbo Trail	BTX24HL-BS
		LXR	BTX20H-BS			EFI 159	B50N-18L-LM		2004	T660 Turbo Trail	BTX24HL-BS
	2010-09	Z1 1100 EFI	BTX20H-BS		2002	Mountain Cat 800			2007-06	T660 Turbo Trail LE	BTX24HL-BS
	2011-09	Z1 1100 EFI LXR	BTX20H-BS			EFI LE 144	B50N-18L-LM	600cc	1997	EXT 600	B18-A
	2011	Z1 Sno Pro	BTX20H-BS		2002	Mountain Cat 800			1998	EXT 600 Tour	B18-A
	2010-09	Z1 Turbo	BTX20H-BS			EFI LE 151	B50N-18L-LM		1998	EXT 600 Triple	B18-A
	2011-10	Z1 Turbo EXT	BTX20H-BS		2001	Mountain Cat 800 LE	B18-A		2008-07	F6 EFI LXR	B18-A
	2010	Z1 Turbo EXT Limited	BTX20H-BS		2002	Mountain Cat 800			2004	Mountain Cat 600 EFI	B18-A
						LE 144	B50N-18L-LM		2002-01	Mountain Cat 600 EFI	B18-A
	2011-09	Z1 Turbo LXR	BTX20H-BS		2002	Mountain Cat 800			2003	Mountain Cat 600 EFI 136	B18-A
	2009	Z1 Turbo LXR LE	BTX20H-BS			LE 151	B50N-18L-LM		2003	Mountain Cat 600 EFI 144	B18-A
	2011-09	Z1 Turbo Sno Pro	BTX20H-BS		1999-98	Pantera 800	B18-A		2002-01	Mountain Cat 600 EFI LE	B18-A
	2011-10	Z1 Turbo Sno Pro Limited	BTX20H-BS		2004	Pantera 800 EFI	B50N-18L-LM		2005-04	Pantera 600 EFI	B18-A
					2003-02	Pantera 800 EFI	B50N-18L-LM		2003-02	Pantera 600 EFI ESR	B18-A
						ESR	B50N-18L-LM		1998-97	Powder Extreme	B18-A
1000cc	2008-07	F1000 EFI LXR	BTX20H-BS		2013	ProClimb XF 800			1997	Powder Special 600	B18-A
	2002-01	Mountain Cat 1000	B18-A			Sno Pro High			1997	Powder Special 600 EFI	B18-A
	2001-00	Pantera 1000	B18-A			Country Ltd	BTX20H-BS		2004	Sabercat 600	B50N-18L-LM
	2000-97	Thundercat MC	B18-A		2013	ProCross F 800 LXR	BTX20H-BS		2005-04	Sabercat 600 EFI	B50N-18L-LM
	2000	Thundercat THC	B18-A		2013	ProCross F 800 Sno			2005-04	Sabercat 600 EFI	B50N-18L-LM
900cc	2005-04	King Cat 900	B50N-18L-LM			Pro Limited	BTX20H-BS			EXT	B50N-18L-LM
	2006-05	King Cat 900 EFI	B50N-18L-LM		2013	ProCross XF 800			2006-04	Sabercat 600 EFI	B50N-18L-LM
	2005	King Cat 900 EFI Early Build	B50N-18L-LM			Crosstour	BTX20H-BS			LX	B50N-18L-LM
	2014	M 9000 153	BTX20H-BS		2013	ProCross XF 800			2004	Sabercat 600 LX	B50N-18L-LM
	2014	M 9000 HCR 162	BTX20H-BS			Sno Pro Limited	BTX20H-BS		2001-99	Triple Touring	B18-A
	2014	M 9000 Limited 162	BTX20H-BS		2014	XF 8000 Crosstour	BTX20H-BS		2003-02	ZL 600 EFI	B18-A
	2014	M 9000 Sno Pro 162	BTX20H-BS		2014	XF 8000 High			2003-02	ZL 600 EFI ESR	B18-A
	2003	Mountain Cat 900				Country Limited	BTX20H-BS		2003-02	ZL 600 EFI SS	B18-A
		144	B50N-18L-LM		2014	XF 8000 Limited	BTX20H-BS		2003-02	ZL 600 EFI SS ESR	B18-A
	2004-03	Mountain Cat 900			2014	XF 8000 LXR	BTX20H-BS		2002-01	ZR 600	B18-A
		151	B50N-18L-LM		2003-02	ZL 800 EFI ESR	B50N-18L-LM		2002-01	ZR 600 EFI	B18-A
	2004	Mountain Cat 900			2001	ZL 800 EFI SS	B50N-18L-LM		2001	ZR 600 EFI LE	B18-A
		159	B50N-18L-LM		2002	ZR 800	B50N-18L-LM		2002-97	ZRT 600	B18-A
	2003	Mountain Cat 900			2001	ZR 800	B18-A		2001	ZRT 600 LE	B18-A
		1M	B50N-18L-LM		2003-02	ZR 800 EFI	B50N-18L-LM		1996-95	EXT 580	B18-A
	2003	Mountain Cat 900			2003	ZR 800 EFI Sno			1998	EXT 580 EFI	B18-A
		Early Build	B50N-18L-LM			Pro	B50N-18L-LM		1997	EXT 580 EFI	12N7-4A
	2004	Mountain Cat 900			2001	ZR 800 LE	B18-A		1997	EXT 580 EFI	12N7-4A
		EFI 151	B50N-18L-LM		2014	ZR 8000 Limited	BTX20H-BS		1998-96	EXT 580 EFI	B50N-18L-LM
	2004	Mountain Cat 900			2014	ZR 8000 LXR	BTX20H-BS			Deluxe	B50N-18L-LM
		EFI 159	B50N-18L-LM		2001-97	ZRT 800	B18-A		1998	Pantera 580	B50N-18L-LM
	2014	XF 9000 Cross			2001	ZRT 800 LE	B18-A		2001-99	Pantera 580 EFI	B18-A
		Country Sno Pro	BTX20H-BS		2005-04	Sabercat 700 EFI	B50N-18L-LM		2000	ZL 580 EFI ESR	B18-A
	2014	XF 9000 Crosstour	BTX20H-BS	700cc	2006-04	Sabercat 700 EFI			1996-95	ZR 580 EFI	12N7-4A
	2014	XF 9000 High				EXT	B50N-18L-LM		1996	ZR 580 EFI ETT	12N7-4A
		Country Limited	BTX20H-BS		2006-04	Sabercat 700 EFI			2014-11	Bearcat 570	B18-A
	2014	XF 9000 High				LX	B50N-18L-LM		2008-04	Bearcat 570 Long	
		Country Sno Pro	BTX20H-BS		1996-95	Wildcat EFI	12N7-4A			Track	B50N-18L-LM
	2014	XF 9000 Limited	BTX20H-BS		1996-95	Wildcat Mountain Cat	12N7-4A		2014-09	Bearcat 570 XT	B18-A
	2014	XF 9000 LXR	BTX20H-BS		1996-95	Wildcat Touring	12N7-4A		2014-08	F570	B18-A
	2014	XF 9000 Sno Pro	BTX20H-BS		2014	XF 7000 Cross			2004-02	Mountain Cat 570	B50N-18L-LM
	2005-03	ZR 900	B50N-18L-LM			Country Sno Pro	BTX20H-BS		2007-04	Panther 570	B50N-18L-LM
	2003	ZR 900 Early Build	B50N-18L-LM		2014	XF 7000 Crosstour	BTX20H-BS		2003-02	Panther 570 ESR	B50N-18L-LM
	2006-04	ZR 900 EFI	B50N-18L-LM		2014	XF 7000 Limited	BTX20H-BS		2002	Panther 570 R	B50N-18L-LM
	2006-04	ZR 900 EFI Sno			2014	XF 7000 LXR	BTX20H-BS		2014-08	T570	B18-A
		Pro	B50N-18L-LM		2014	XF 7000 Sno Pro	BTX20H-BS		2005-04	Z 570	B50N-18L-LM
	2005-03	ZR 900 Sno Pro	B50N-18L-LM		2014	ZR 7000 Limited	BTX20H-BS		2003-02	Z 570 ESR	B50N-18L-LM
	2014	ZR 9000 Limited	BTX20H-BS		2014	ZR 7000 LXR	BTX20H-BS		2007-04	Z 570 LX	B50N-18L-LM
	2014	ZR 9000 LXR	BTX20H-BS		2014	ZR 7000 Sno Pro	BTX20H-BS		2002	Z 570 SS	B50N-18L-LM
	2014	ZR 9000 RR	BTX20H-BS		2003-02	4-Stroke Touring	B50N-18L-LM		2005	Bearcat Widetrack	BTX24HL-BS
	2014	ZR 9000 Sno Pro	BTX20H-BS	660cc	2003-02	4-Stroke Trail	B50N-18L-LM		2004-03	Bearcat Widetrack	B50N-18L-LM
	2002-97	Thundercat	B18-A		2008-06	Bearcat Widetrack	BTX24HL-BS		2002-96	Bearcat Widetrack	B18-A
895cc	2002-97	Thundercat	B18-A		2008-06	Bearcat Widetrack	BTX24HL-BS		1998-95	Cougar	B18-A
800cc	2011-07	F8 EFI LXR	BTX20H-BS			Turbo	BTX24HL-BS		1996	Cougar 2-Up	B18-A
	2009	F8 EFI LXR LE	BTX20H-BS		2008-06	Bearcat Widetrack	BTX24HL-BS		1998-95	Cougar Mountain Cat	B18-A
	2011	F8 EXT	BTX20H-BS			Turbo Articulating	BTX24HL-BS		1996-95	EXT EFI	12N7-4A
	2014	M 8000 Limited ES			2008-06	Panther 660			1996	EXT EFI (Optional)	B50N-18L-LM
		153	BTX20H-BS			Touring	B50N-18L-LM		1995	EXT EFI (Optional)	B18-A
	2014	M 8000 Limited ES			2007-06	Panther 660 Trail	B50N-18L-LM		1996-95	EXT EFI Mountain Cat	12N7-4A
		162	BTX20H-BS		2008-04	T660 Touring	B50N-18L-LM		1996	EXT EFI Mountain Cat	12N7-4A
	2002	Mountain Cat 800	B50N-18L-LM		2005	T660 Turbo	BTX24HL-BS		1996	EXT EFI Mountain Cat	12N7-4A
	2001	Mountain Cat 800	B18-A		2006-05	T660 Turbo ST	BTX24HL-BS		1995	EXT EFI Mountain Cat	12N7-4A
	2002	Mountain Cat 800			2005	T660 Turbo ST EFI				EXT EFI Mountain Cat	B50N-18L-LM
		EFI	B50N-18L-LM			Early Build	BTX24HL-BS			(Optional)	B18-A
	2003	Mountain Cat 800			2007-04	T660 Turbo Touring	BTX24HL-BS		1996-95	EXT Powder Special	B18-A
		EFI 144	B50N-18L-LM								

# POWERSPORT - Snowmobile

ENGINE	YEAR	MODEL	JIS Battery Type	ENGINE	YEAR	MODEL	JIS Battery Type	ENGINE	YEAR	MODEL	JIS Battery Type	
<b>ARCTIC CAT (Cont.)</b>				<b>POLARIS (Cont.)</b>				<b>POLARIS (Cont.)</b>				
550cc	1997-95	Pantera .....	B50N-18L-LM	800cc	2014	800 RMK Assault		700cc	1998-97	Ultra (Electric Start) .....	B14A-A2	
	2005-02	Pantera 550 .....	B18-A			155 LE .....	BTX20CH-BS		1996	Ultra SKS .....	B9A-A	
	2001-97	Panther 550 .....	B18-A		2013-11	800 Rush .....	BTX20CH-BS		1996	Ultra SKS (Electric Start) .....	B14A-A2	
	2003-01	ZL 550 .....	B18-A		2014-11	800 Rush PRO-R .....	BTX20CH-BS		1997-96	Ultra SP .....	B9A-A	
	2003-00	ZL 550 ESR .....	B18-A		2014	800 Rush PRO-R LE .....	BTX20CH-BS		1997-96	Ultra SP (Electric Start) .....	B14A-A2	
500cc	1998	Cougar Deluxe .....	B18-A		2012	800 Rush PRO-R LE .....	BTX20CH-BS		1997	Ultra SPX .....	B9A-A	
	2014-13	F5 .....	B18-A			800 SKS (Electric Start) ...	B14A-A2		1997	Ultra SPX (Electric Start) .....	B14A-A2	
	2011-07	F5 EFI LXR .....	B18-A		2003	800 SwitchBack .....	BTX20CH-BS		1997	Ultra SPX SE .....	B9A-A	
	2012	F5 LXR .....	B18-A		2014	800 SwitchBack .....	BTX20CH-BS		1997	Ultra SPX SE (Electric Start) .....	B14A-A2	
	2002	Mountain Cat 500 .....	B18-A		2012-11	800 SwitchBack (Electric Start) .....	B14A-A2		1997	Ultra Touring .....	B9A-A	
	2005-04	Sabercat 500 .....	B50N-18L-LM		2005-04	800 SwitchBack Adventure .....	BTX20CH-BS		1998-97	Ultra Touring (Electric Start) .....	B14A-A2	
	2006	Sabercat 500 EFI .....	B50N-18L-LM		2014	800 SwitchBack Assault 144 .....	BTX20CH-BS		600cc	2014	600 INDY .....	BTX20CH-BS
	2006	Sabercat 500 EFI LX .....	B50N-18L-LM		2014-11	800 SwitchBack Assault LE .....	BTX20CH-BS		2014	600 INDY SP LE .....	BTX20CH-BS	
	2005-04	Sabercat 500 LX .....	B18-A		2014	800 SwitchBack PRO-R .....	BTX20CH-BS		2014	600 INDY Voyager .....	BTX20CH-BS	
	2005-04	Sabercat 500 LX (Optional) .....	B50N-18L-LM		2014	800 SwitchBack PRO-R LE .....	BTX20CH-BS		2012-09	600 IQ Shift .....	BTX20HL-BS	
	2009-08	T500 .....	B18-A		2013-12	800 SwitchBack Pro-R .....	BTX20CH-BS		2009	600 IQ Shift 136 .....	BTX20HL-BS	
	2002	ZL 500 .....	B18-A		2014	800 SwitchBack Pro-R LE .....	BTX20CH-BS		2010-09	600 IQ Touring .....	BTX20HL-BS	
	2000	ZL 500 .....	B18-A		2005-04	800 Touring (Electric Start) .....	B14A-A2		2014	600 IQ Widetrack .....	BTX20L	
	2002-01	ZR 500 .....	B18-A		2004-03	800 XC (Electric Start) .....	B14A-A2		2013-11	600 IQ Widetrack .....	BTX20HL-BS	
	2001	ZR 500 EFI .....	B18-A		2005-01	800 XC SP (Electric Start) .....	B14A-A2		2014-12	600 PRO-RMK 155 .....	BTX20CH-BS	
	2001	ZR 500 EFI ESR .....	B18-A		2003-99	800 XCR (Electric Start) ...	B14A-A2		2014-11	600 RMK 144 .....	BTX20CH-BS	
	2002	ZR 500 LE .....	B18-A		2002	Frontier (Electric Start) .....	B14A-A2		2014-11	600 RMK 155 .....	BTX20CH-BS	
	2014	ZR 5000 LXR .....	BTX20H-BS		2004-03	Frontier Classic (Electric Start) .....	B14A-A2		2013-10	600 Rush .....	BTX20CH-BS	
440cc	1998-95	Bearcat 440 .....	B14-A2		2005-03	Frontier Touring (Electric Start) .....	B14A-A2		2014-11	600 Rush PRO-R .....	BTX20CH-BS	
	2000-99	Bearcat 440 I .....	B14-A2		1997-95	Storm .....	B9A-A		2014-09	600 SwitchBack .....	BTX20HL-BS	
	2000-99	Bearcat 440 II .....	B14-A2		1998-95	Storm (Electric Start) .....	B14A-A2		2014-12	600 SwitchBack Adventure .....	BTX20HL-BS	
	1999-98	Jag 440 .....	B14-A2		1997	Storm SE .....	B9A-A		2014	600 SwitchBack Assault 144 .....	BTX20HL-BS	
	1999-98	Jag 440 Deluxe .....	B14-A2		1997	Storm SE (Electric Start) ..	B14A-A2		2014	600 SwitchBack PRO-R .....	BTX20HL-BS	
	1997-95	Jag Deluxe .....	B14-A2		1996-95	Storm SKS .....	B9A-A		2013-12	600 SwitchBack Pro-R .....	BTX20HL-BS	
	1996	Jag Liquid .....	B14-A2		1996-95	Storm SKS (Electric Start) .....	B14A-A2		550cc	2014	550 INDY .....	BTX20CH-BS
	2002-97	Panther 440 .....	B14-A2			FS Classic .....	BTX20L-BS		2014	550 INDY 144 .....	BTX20CH-BS	
	2001	Panther 440 ESR .....	B14-A2		2006	FS IQ Touring .....	BTX20L-BS		2014	550 INDY Adventure .....	BTX20CH-BS	
	1996-95	Panther Deluxe .....	B14-A2		2009-07	FS IQ Touring .....	BTX20L-BS		2014	550 INDY LXT .....	BTX20CH-BS	
	1996	Panther LC .....	B14-A2		2006	FS Touring .....	BTX20L-BS		2014	550 INDY Voyager .....	BTX20CH-BS	
	1995	Prowler 2-Up .....	B18-A		2006	FST Classic .....	BTX20L-BS		2013-11	550 IQ LXT .....	BTX20HL-BS	
	2002-98	Z 440 .....	B14-A2		2006	FST Classic .....	BTX20L-BS		2013-09	550 IQ Shift .....	BTX20HL-BS	
	2002-00	Z 440 ES .....	B14-A2		2007	FST IQ .....	BTX20L-BS		2013-11	550 Shift 136 .....	BTX20HL-BS	
	2003	Z 440 ESR .....	B14-A2		2007	FST IQ Cruiser .....	BTX20L-BS		1997-95	Sport .....	B9A-A	
	2006-04	Z 440 LX .....	B14-A2		2008-07	FST IQ LX .....	BTX20L-BS		2000-95	Sport (Electric Start) .....	B14A-A2	
370cc	2008-07	Panther 370 .....	B14-A2		2007	FST IQ LX .....	BTX20L-BS		1997-95	Sport Touring .....	B9A-A	
	2004	Panther 370 .....	B14-A2		2007-06	FST SwitchBack .....	BTX20L-BS		2004-95	Sport Touring (Electric Start) .....	B14A-A2	
	2001	Panther 370 .....	B14-A2		2006	FST Touring .....	BTX20L-BS		2001	Sport Touring ES (Electric Start) .....	B14A-A2	
	2006-05	Panther 370 R .....	B14-A2		2008	IQ Turbo LX .....	BTX20L-BS		1997-95	Super Sport .....	B9A-A	
	2003	Panther 370 R .....	B14-A2		2008	Turbo Dragon .....	BTX20L-BS		2005-95	Super Sport (Electric Start) .....	B14A-A2	
	2005-99	Z 370 .....	B14-A2		2011	Turbo IQ .....	BTX20L-BS		2003	Super Sport X (Electric Start) .....	B14A-A2	
	2002-00	Z 370 ES .....	B14-A2		2010	Turbo IQ LX .....	BTX20L-BS		2010	Trail Touring .....	B14A-A2	
	2003	Z 370 ESR .....	B14-A2		2004-01	700 Classic (Electric Start) .....	B14A-A2		1997-96	Trail Touring .....	B9A-A	
	2007-04	Z 370 LX .....	B14-A2		2004-03	700 Classic Touring (Electric Start) .....	B14A-A2		2005-02	Trail Touring (Electric Start) .....	B14A-A2	
340cc	2000-95	Bearcat 340 .....	B14-A2		2004	700 Edge Touring (Electric Start) .....	B14A-A2		2000-96	Trail Touring (Electric Start) .....	B14A-A2	
	1997-95	Jag .....	B14-A2		2004-03	700 PRO X (Electric Start) .....	B14A-A2		2005	Trail Touring DLX (Electric Start) .....	B14A-A2	
	1998	Jag 340 .....	B14-A2		1997	700 SKS .....	B9A-A		1997-95	Classic .....	B9A-A	
	1999-98	Jag 340 Deluxe .....	B14-A2		2003-99	700 SKS (Electric Start) ...	B14A-A2		1998-95	Classic (Electric Start) .....	B14A-A2	
	2000-98	Panther 340 .....	B14-A2		1997	700 SKS (Electric Start) ...	B14A-A2		1997-96	Classic Touring .....	B9A-A	
	1997-95	Puma .....	B14-A2		2004	700 SwitchBack (Electric Start) .....	B14A-A2		2000-96	Classic Touring (Electric Start) .....	B14A-A2	
	1997-95	Puma 2-Up .....	B14-A2		1997	700 XC .....	B9A-A		1995	Trail Deluxe .....	B9A-A	
	1997-95	Puma Deluxe .....	B14-A2		2004-03	700 XC (Electric Start) .....	B14A-A2		1995	Trail Deluxe (Electric Start) .....	B14A-A2	
<b>POLARIS</b>												
800cc	2004	800 Classic (Electric Start) .....	B14A-A2		2004	700 Classic Touring (Electric Start) .....	B14A-A2		2003	Super Sport X (Electric Start) .....	B14A-A2	
	2004-03	800 Classic Touring (Electric Start) .....	B14A-A2		2004	700 Edge Touring (Electric Start) .....	B14A-A2		2010	Trail Touring .....	B14A-A2	
	2014	800 INDY SP .....	BTX20CH-BS		2004-03	700 PRO X (Electric Start) .....	B14A-A2		1997-96	Trail Touring .....	B9A-A	
	2014	800 INDY SP LE .....	BTX20CH-BS		1997	700 SKS .....	B9A-A		2005-02	Trail Touring (Electric Start) .....	B14A-A2	
	2001	800 LE (Electric Start) .....	B14A-A2		2003-99	700 SKS (Electric Start) ...	B14A-A2		2000-96	Trail Touring (Electric Start) .....	B14A-A2	
	2003	800 PRO X (Electric Start) .....	B14A-A2		1997	700 SKS (Electric Start) ...	B14A-A2		2005	Trail Touring DLX (Electric Start) .....	B14A-A2	
	2004	800 PRO XR (Electric Start) .....	B14A-A2		2004	700 SwitchBack (Electric Start) .....	B14A-A2		1997-95	Classic .....	B9A-A	
	2014-11	800 PRO-RMK 155 .....	BTX20CH-BS		1997	700 XC .....	B9A-A		1998-95	Classic (Electric Start) .....	B14A-A2	
	2014-11	800 PRO-RMK 163 .....	BTX20CH-BS		2004-03	700 XC (Electric Start) .....	B14A-A2		1997-96	Classic Touring .....	B9A-A	
	2014	800 PRO-RMK LE .....	BTX20CH-BS		1999-97	700 XC (Electric Start) .....	B14A-A2		2000-96	Classic Touring (Electric Start) .....	B14A-A2	
	2014-11	800 RMK 155 .....	BTX20CH-BS		2000	700 XC Deluxe (Electric Start) .....	B14A-A2		1995	Trail Deluxe .....	B9A-A	
	2014-11	800 RMK Assault 155 .....	BTX20CH-BS		2005-99	700 XC SP (Electric Start) .....	B14A-A2		1997-95	Wide Trak GT .....	B9A-A	
					1999-98	700 XCR (Electric Start) ...	B14A-A2		1997-95	Wide Trak GT (Electric Start) .....	B14A-A2	
					1997	Ultra .....	B9A-A		1997-95	Wide Trak LX .....	B9A-A	

# POWERSPORT - Snowmobile

ENGINE	YEAR	MODEL	JIS Battery Type	ENGINE	YEAR	MODEL	JIS Battery Type	ENGINE	YEAR	MODEL	JIS Battery Type
<b>POLARIS (Cont.)</b>				<b>SKI-DOO (Cont.)</b>				<b>YAMAHA (Cont.)</b>			
500cc	2005-95	Wide Trak LX (Electric Start) .....	B14A-A2	670cc	1998-96	MX Z 670 .....	B50-N18L-A3	1000cc	2014-12	FX10M FX Nytro	
488cc	1997-95	Trail .....	B9A-A		1998-95	Summit 670 .....	B50-N18L-A3			MTX 153 .....	BTX20L-BS
	1999-95	Trail (Electric Start) .....	B14A-A2	600cc	2010	Expedition 600 .....	BTX20L		2014-12	FX10M FX Nytro	
450cc	1997	XCF .....	B9A-A		2010	Expedition 600 SE .....	BTX20L			MTX 162 .....	BTX20L-BS
	2000-97	XCF (Electric Start) .....	B14A-A2		1997-95	Formula III .....	B50-N18L-A3	2011-10		FX10M FX Nytro	
	2001	XCF SP (Electric Start) .....	B14A-A2		1998	Formula III 600 .....	B50-N18L-A3	2010-08		MTX SE 153 .....	BTX20L-BS
	1999	XCF SP (Electric Start) .....	B14A-A2		1998	Formula III 600 LT .....	B50-N18L-A3		2008	FX10MTR FX Nytro	
435cc	1997-96	Tran Sport .....	B9A-A		1998	Formula III 600 R .....	B50-N18L-A3			MTX .....	BTX20L-BS
	1999-96	Tran Sport (Electric Start) .....	B14A-A2		1997-96	Formula III LT .....	B50-N18L-A3	2008		FX10MTR FX Nytro	
					2010	Grand Touring 600 LE .....	BTX20L		2008	MX .....	BTX20L-BS
340cc	1997-95	Lite .....	B9A-A		2010	G SX 600 Limited .....	BTX20L			FX10MTR FX Nytro	
	1998-95	Lite (Electric Start) .....	B14A-A2		2010	Renegade 600 .....	BTX20L			MTX SE 40th Anniv .....	BTX20L-BS
	1997-95	Lite Deluxe .....	B9A-A		2010	Renegade 600 Adrenaline .....	BTX20L	2011-10		FX10MTS FX Nytro	
	1998-95	Lite Deluxe (Electric Start) .....	B14A-A2		2010	Backcountry .....	BTX20L		2008	MTX SE 162 .....	BTX20L-BS
					2010	Renegade 600 X .....	BTX20L	2008		FX10RT FX Nytro	
	1997-95	Lite GT .....	B9A-A		2010	Summit 600 Everest 146 .....	BTX20L			RTX Non-Reverse .....	BTX20L-BS
	1997-95	Lite GT (Electric Start) .....	B14A-A2		2010	Summit 600 Sport .....	BTX20L	2013-08		FX10RTR FX Nytro	
	1998	Lite Touring (Electric Start) .....	B14A-A2		2010	Summit 600 X 154 .....	BTX20L		2008	RTX .....	BTX20L-BS
					2010	Summit Sport .....	BTX20L		2008	FX10RTRA FX Nytro	
250cc	1995	Starlite .....	B9A-A		2010	Summit 600 X 154 .....	BTX20L			RTX 40th Anniv .....	BTX20L-BS
	1995	Starlite (Electric Start) .....	B14A-A2	599cc	2011	Summit Sport .....	BTX20L	2010-09		FX10RTRS FX Nytro	
120cc	2005-04	120 Pro X (Electric Start) .....	B14A-A2		1995	Formula 599 .....	B50-N18L-A3			RTX SE .....	BTX20L-BS
	2003-01	120 XC SP (Electric Start) .....	B14A-A2	583cc	1997	Formula 583 .....	B50-N18L-A3	2012-09		FX10XT FX Nytro	
	2000	120 XCR (Electric Start) .....	B14A-A2		1998	Formula Deluxe 583 .....	B50-N18L-A3			XTX .....	BTX20L-BS
					1998	Formula Z 583 .....	B50-N18L-A3	2014-13		FX10XT FX Nytro	
					1998-97	Grand Touring 583 .....	B50-N18L-A3			XTX 1.75 .....	BTX20L-BS
					1998-96	MX Z 583 .....	B50-N18L-A3	2005		RX10 RX-1 .....	BTX14-BS
					1998-95	Summit 583 .....	B50-N18L-A3	2004-03		RX10 RX-1 .....	BTX20L-BS
					1998-95	Formula Mach 1 .....	B50-N18L-A3	2010-06		RX10GT Apex GT .....	BTX14-BS
					1995	Formula Mach Z .....	B50-N18L-A3	2008		RX10GTA Apex GT	
					1998-95	Formula S .....	B50-N18L-A3		2010-08	40th Anniv .....	BTX14-BS
					1998	Formula S Electric .....	B50-N18L-A3		2010-08	RX10LT Apex LTX .....	BTX14-BS
					1998-95	Formula SL .....	B50-N18L-A3			RX10LTGT Apex LTX	
					1996	Formula SLS .....	B50-N18L-A3			GT .....	BTX14-BS
					1996-95	Formula SS .....	B50-N18L-A3	2008		RX10LTGTA Apex	
					1996-95	Formula STX .....	B50-N18L-A3			LTX GT 40th Anniv .....	BTX14-BS
					1995	Formula STX LT .....	B50-N18L-A3	2007-06		RX10M Apex	
					1996	Formula STX LT 2-Pass .....	B50-N18L-A3		2005	Mountain .....	BTX14-BS
					1997-95	Formula Z .....	B50-N18L-A3			Mountain .....	BTX14-BS
					1996-95	Grand Touring 580 .....	B50-N18L-A3	2004-03		RX10M RX-1	
					2010	Renegade 550F Sport .....	BTX20L		2007	Mountain SE .....	BTX14-BS
					550cc	Alpine II .....	B50-N18L-A3		2005	RX10MS RX-1	
					500cc	Formula 500 .....	B50-N18L-A3			Mountain LE .....	BTX14-BS
					1998-97	Formula Deluxe 500 .....	B50-N18L-A3	2004-03		RX10MS RX-1	
					1998-97	Grand Touring 500 .....	B50-N18L-A3			Mountain LE .....	BTX20L-BS
					1998	MX Z 500 .....	B50-N18L-A3	2010-08		RX10MT Apex MTX .....	BTX14-BS
					1998-95	Skandic 500 .....	B50-N18L-A3	2008		RX10MTA Apex MTX	
					1995	Skandic Ski Hill Special .....	B50-N18L-A3			SE 40th Anniv .....	BTX14-BS
					1998	Skandic WT LC .....	B50-N18L-A3	2014-11		RX10PS Apex SE .....	BTX14-BS
					1998-96	Summit 500 .....	B50-N18L-A3	2014-08		RX10PX Apex XTX .....	BTX14-BS
					1998-95	Touring SLE .....	B50-N18L-A3	2007-06		RX10R Apex .....	BTX14-BS
					470cc	Grand Touring 470 .....	B50-N18L-A3		2005-03	RX10R Apex ER .....	BTX14-BS
					460cc	Formula MX .....	B50-N18L-A3		2005-03	RX10R RX-1 ER .....	BTX20L-BS
						Formula MX Z .....	B50-N18L-A3	2005-03		RX10RS RX-1 ER LE .....	BTX20L-BS
					440cc	MX Z 440 Fan .....	B50-N18L-A3	2009		RX10RT Apex RTX .....	BTX14-BS
						MX Z 440 LC .....	B50-N18L-A3	2007-06		RX10RT Apex RTX .....	BTX14-BS
						Touring LE .....	B50-N18L-A3	2008-07		RX10RTR Apex RTX	
					380cc	Skandic 380 .....	B50-N18L-A3			ER .....	BTX14-BS
					370cc	Touring E .....	B50-N18L-A3	2004-03		RX10S RX-1 LE .....	BTX20L-BS
						Touring E LT .....	B50-N18L-A3	2007-06		RXW10 Attack .....	BTX14-BS
					270cc	Tundra II LT .....	B50-N18L-A3	2005-04		RXW10 RX Warrior .....	BTX20L-BS
					250cc	Elan 250 .....	B50-N18L-A3	2007		RXW10GT Attack GT .....	BTX14-BS
								2005-04		RXW10S RX Warrior	
										LE .....	BTX20L-BS
								2014-06		VK10 Viking	
										Professional .....	BTX20L-BS
								900cc	2007	RS Venture GT .....	BTX20L-BS
									2006-05	RS90 RS Vector .....	BTX20L-BS
									2011-06	RS90GT Vector GT .....	BTX20L-BS
									2008	RS90GTA RS Vector	
										40th Anniv .....	BTX20L-BS
									2014-12	RS90LT RS Vector	
										LTX .....	BTX20L-BS
									2009-08	RS90LT RS Vector	
										LTX .....	BTX20L-BS

# POWERSPORT - Snowmobile

ENGINE	YEAR	MODEL	JIS Battery Type	ENGINE	YEAR	MODEL	JIS Battery Type
<b>YAMAHA (Cont.)</b>				<b>YAMAHA (Cont.)</b>			
900cc	2009	RS90LTGT RS Vector LT GT	BTX20L-BS	600cc	1998	VX600SXS VMAX 600 SXS	B16AL-A2
	2011-08	RS90LTGT RS Vector LTX GT	BTX20L-BS		1998-97	VX600XT VMAX 600 XT	B16AL-A2
	2007-05	RS90M RS Vector Mountain	BTX20L-BS		1998-97	VX600XTC VMAX 600 XTC	B16AL-A2
	2007-06	RS90MS RS Vector Mountain SE	BTX20L-BS		1997	VX600XTC VMAX 600 XTC (Reverse)	B16AL-A2
	2007-06	RS90N Nytro	BTX20L-BS		1998	VX600XTCD VMAX 600 XTC Deluxe	B16AL-A2
	2007-06	RS90NR Nytro ER	BTX20L-BS		1998	VX600XTR VMAX 600 XTR	B16AL-A2
	2014-12	RS90R RS Vector	BTX20L-BS		1996	VX600XTW VMAX 600 XT Proaction Plus	B16AL-A2
	2009-08	RS90R RS Vector	BTX20L-BS	540cc	1998-95	VK540 II	B16AL-A2
	2007-05	RS90R RS Vector ER	BTX20L-BS		2005-99	VK540 III	B16AL-A2
	2007-05	RSG90 RS Rage	BTX20L-BS	500cc	2009-07	PZ50 Phazer	BTX14-BS
	2007	RSG90GT RS Rage GT	BTX20L-BS		2001-99	PZ500 Phazer 500 (w/ Electric Start Kit)	B16AL-A2
	2014-05	RST90 RS Venture	BTX20L-BS		2001	PZ500DX Phazer Deluxe	B16AL-A2
	2014-07	RST90GT RS Venture GT	BTX20L-BS		2001-00	PZ500ML Phazer Mountain Lite (w/ Electric Start Kit)	B16AL-A2
700cc	2003-01	MM700 Mountain Max 700	B50-N18L-A		2007	PZ50FX Phazer FX	BTX14-BS
	2000	MM700 Mountain Max 700	B16AL-A2		2013-07	PZ50GT Phazer GT	BTX14-BS
	1999-98	MM700 Mountain Max 700	B50-N18L-A		2008-07	PZ50MT Phazer Mountain Lite	BTX14-BS
	2001-00	SX700/R	B50-N18L-A		2014-09	PZ50MT Phazer MTX	BTX14-BS
	2000	SX700S	B50-N18L-A		2014-08	PZ50RTX Phazer RTX	BTX14-BS
	2004-02	SXV700 SX Viper	B50-N18L-A		2013-07	PZ50VT Venture Lite	BTX14-BS
	2004-02	SXV700ER SX Viper ER	B50-N18L-A3		2014	PZ50XT Phazer XTX	BTX14-BS
	2006-03	SXV700MH SX Viper Mountain	B50-N18L-A		2014-13	RPZ50 Venture MP	BTX14-BS
	2004-98	VT700 Venture 700	B50-N18L-A		2001-00	SX500/R	B16AL-A2
	2001-99	VX700 VMAX 700	B50-N18L-A		2001-97	VT500 Venture 500	B16AL-A2
	2001	VX700DX VMAX 700 Deluxe	B50-N18L-A		2001-99	VT500XL Venture 500 XL	B16AL-A2
	2000-99	VX700DX VMAX 700 Deluxe	B50-N18L-A3		2001-95	VX500 VMAX 500	B16AL-A2
	2002	VX700ER VMAX 700 ER	B50-N18L-A3		2001-00	VX500DX VMAX 500 Deluxe	B16AL-A2
	1999-98	VX700SX VMAX 700 SX	B50-N18L-A		1996-95	VX500DX VMAX 500 DX	B16AL-A2
	1998	VX700SXS VMAX 700 SXS	B50-N18L-A		1996-95	VX500E VAMX 500 LE	B16AL-A2
	1998	VX700XT VMAX 700 XT	B50-N18L-A		1999	VX500ER	B16AL-A2
	1998	VX700XTC VMAX 700 XTC	B50-N18L-A3		1999	VX500SX VMAX 500 SX	B16AL-A2
	1998	VX700XTCD VMAX 700 XTC Deluxe	B50-N18L-A3		1998-97	VX500XT VMAX 500 XT	B16AL-A2
	1998	VX700XTCP VMAX 700 XTCP	B50-N18L-A		1998-97	VX500XTC VMAX 500 XTC	B16AL-A2
600cc	2002-01	MM600 Mountain Max 600	B50-N18L-A		1998	VX500XTCD VMAX 500 XTC Deluxe	B16AL-A2
	2000-97	MM600 Mountain Max 600	B16AL-A2		1998	VX500XTR VMAX 500 XTR	B16AL-A2
	2003-00	SX600/R	B50-N18L-A		1996	VX500XTW VMX 500 XT Proaction Plus	B16AL-A2
	2006-04	SXV60 SX Venom	B50-N18L-A	480cc	1996-95	PZ480E Phazer II LE	B14L-A2
	2006-04	SXV60ER SX Venom ER	B50-N18L-A		1998-97	PZ480E Phazer SS Electric	B14L-A2
	2006-99	VT600 Venture 600	B50-N18L-A		1995	PZ480ST Phazer II ST (w/Electric Start Kit)	B14-A2
	1998-97	VT600 Venture 600	B16AL-A2		1995	PZ480ST Phazer II ST (w/Electric Start Kit)	B14-A2
	1999	VX600 VMAX 600	B16AL-A2		1999-96	PZ480ST Phazer Mountain Lite (w/Electric Start Kit)	B14-A2
	1997-95	VX600 VMAX 600	B16AL-A2		1997-95	VT480 Venture XL	B14L-A2
	2001-00	VX600DX VMAX 600 Deluxe	B50-N18L-A3		1998	VT480TR Venture TR	B14L-A2
	1996-95	VX600DX VMAX 600 DX	B16AL-A2	410cc	1995	ET410TR Enticer II LT	B14-A2
	1996-95	VX600E VMAX 600 LE	B16AL-A2	340cc	2000-95	CS340E Ovation LE	B14L-A2
	2003-02	VX600ER VMAX 600 ER	B50-N18L-A3				
	1996	VX600ST VMAX 600 Mountain Max	B16AL-A2				
	1995	VX600ST VMAX 600 ST	B16AL-A2				
	1999-98	VX600SX VMAX 600 SX	B16AL-A2				





## 2014 Part Application Footnotes

Footnote ID	Description
2	Two batteries may be required
3	Three batteries may be required
4	Four batteries may be required
5	Five batteries may be required
6	Best-fit estimate, see note on page 2. May need to be modified. Check clearance before connecting cables
7	Check polarity before connecting cables
8	In the absence of a cold cranking rating, the amp hour rating is shown
9	Manufacturer's recommended replacement battery shown, may vary from OE battery
10	Modification of the holddown may be necessary
11	OE battery has flush vents
12	OE battery has type F terminals
14	Polarity reversed, check before installing
15	Polarity varies in production, some vehicles require a Group 26R, check before installing
16	Requires individual vent caps for proper hood clearance, do not fit batteries with pod type vent caps
19	See manufacturer's service information for retrofit
20	Some models require Group 91, check OE battery
21	Some vehicles may use a Group 35, check polarity before installing
22	Special 12-volt: 9 5/8" x 6 7/8" x 7 9/16", check polarity before installing
23	Special 12-volt: 10" x 6 1/16" x 8 3/4". assembly no. 25. Check polarity before installing
24	Special 12-volt: 14 15/16" x 6 3/4" x 7 3/8"
27	Special 12-volt: 9 7/8" x 6 21/32" x 3 11/16", Assembly no. 11
28	Special 12-volt: 9 9/16" x 6 13/16" x 6 11/16", Assembly no. 26
29	Special 12-volt: 9 9/16" x 6 13/16" x 6 13/16", Assembly no. 24. Check polarity before installing
30	Special 12-volt: 9" x 7 1/4" x 7 1/26", Assembly no. 15
31	Requires special deep cycle battery
32	Special maintenance-free cycling battery
34	Vibration resistance battery
35	Without handle bracket
36	Identical to 72H shown in manufacturer's literature
37	Check hood clearance
39	Remote vented
40	Battery is encased within an "Active Cooling Box" with an air snorkel to the outside of the engine compartment
42	Same dimensions as Group 27 but uses type X terminals
43	OE battery has non-standard terminal location. May require cable modifications
44	w/o HBL but with ETR, Travel Computer Cluster or Audible Message Center
45	Non-BCI Group Size
46	Dual Terminal Battery
47	OE Battery is AGM (Valve Regulated Lead Battery)
48	Trailer Tow Package, Engine Heater or Canada
49	Requires special steel tray
50	Uses starting or deep cycle type battery
51	Gel Electrolyte
52	DIN/EN size
53	A battery spacer kit is required on some models
54	Battery is vented to outside of vehicle
55	Battery may require vent hose
56	Amp-hour rating from O.E. manufacturer is converted to approximate CCA rating (Ah x 10 = approximate CCA)
57	O.E. manufacturer used various size batteries in production. Carefully size to fit.
58	Check polarity before installing, may vary in production
59	Must use factory activated battery only
60	With sensor
61	With terminal adapter
62	Deep cycle marine group 27
63	Requires center line terminal
64	May require terminal adapter
65	May require water sensor
66	Best performance estimate
67	Vehicle computer system must be reset, contact your service specialist
68	Vehicle service release must be reset, contact your service specialist
69	AGM Valve Regulated Lead Acid (VRLA) is required
70	PR Codes denote factory installed options for the vehicle
71	Call service specialist before changing battery

# www.SourceBCI.com

Is now available

It contains the entire Data Book data base  
in a searchable format

Your free subscription code is printed  
on the front of this Data Book

Go to [www.SourceBCI.com](http://www.SourceBCI.com), enter your  
subscription code, your name, your user name,  
password, and email address for access



Adair Graphic Communications  
7850 Second St., Dexter, MI 48130  
[www.adairgraphic.com](http://www.adairgraphic.com)

**Battery Council  
International™**



Battery Council International  
330 North Wabash Avenue  
Chicago, IL 60611  
(312) 644-6610



**Power Systems Research**  
*Powerful Possibilities™*

1365 Corporate Center Curve  
St. Paul, MN 55121  
[www.powersys.com](http://www.powersys.com)  
[info@powersys.com](mailto:info@powersys.com)